

INNOVATIONS OF THE UNIVERSITIES AND SCIENTIFIC INSTITUTIONS OF THE MINISTRY OF EDUCATION AND SCIENCE OF UKRAINE

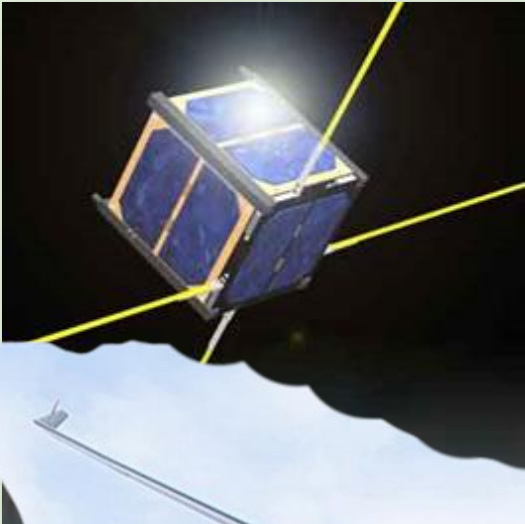

MINISTRY
OF EDUCATION AND SCIENCE
OF UKRAINE

Kyiv 2018

Ministry of Education and Science of Ukraine

**INNOVATIONS OF THE UNIVERSITIES
AND SCIENTIFIC INSTITUTIONS OF
THE MINISTRY OF EDUCATION AND
SCIENCE OF UKRAINE**

Kyiv
2018

UDC 001.895 (477) (035)

Recommended for publication by the Board of the Council of the Vice-Rectors for Science and Research of the Universities and Directors of the Scientific Institutions of the Ministry of Education and Science of Ukraine on the March 29, 2018.

Innovative solutions of universities and scientific institutions of MES of Ukraine / Group of authors under the general editorship of M. Strikha and M. Ilchenko. – K.: Publishing House of the Gifted Child Institute of National Academy of Sciences of Ukraine, 2018. – 278 p.

The compendium contains the product descriptions of 240 scientific and technical innovations of the universities which correspond to the promising directions of domestic economy and illustrate creative function of science at higher education institutions dealing with cutting-edge high-tech products development. The information concerning the experience of universities in the innovations commercialization and transfer of technologies to domestic and foreign markets is also outstanding and newsworthy.

For senior government officials, innovative business, manufacturing, as well as experts interested in issues related to organizing of innovative activities in Ukraine.

Content of illustrations of the compendium cover page:

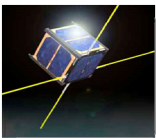

The first Ukrainian university's nanosatellite "PolyITAN" created at Igor Sikorsky KPI has been operating successfully in the near-Earth orbit since the 19th of June 2014. The results obtained are used while producing and launching the second spacecraft "PolyITAN-2-SAU" within the international scientific project QB50 dealing with the Earth thermosphere research.



The deep cleaning technology for residential and resembling in composition waste waters developed at Kremenchuk Mykhailo Ostrohradskyi National University has been implemented at score of objects in majority of regions of Ukraine and tested in Algeria and Belgium. Protected with a number of patents of Ukraine.



UAS "Spectator" is protected with 4 patents of Ukraine and in-demand in the military industrial complex as well as in the agricultural industry of Ukraine. The invention of Igor Sikorsky KPI is ramped up to serial production at OJSC "Meridian" named after S.P. Korolyov.



Rotary oscillating granulator for nitrogen fertilizers melting is produced at Sumy State University and protected with over 30 patents of Ukraine on the inventions and utility models. The innovation is implemented at nitrogen fertilizer plants of Bulgaria, Estonia, Qatar, Cuba, Poland, Republic of Belarus, Tajikistan, Uzbekistan, Ukraine and other countries.



New generation of military and civil purposes machines is created due to the implementation of discrete strengthening technology for machines parts, developed by NTU "Kharkiv Politechnic Institute". The R&D product is protected with 23 patents of Ukraine.

Content of the compendium back page

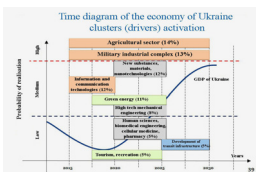

Activation periods of main projected drivers (clusters) of the economy of Ukraine. Scenarios of socio-economic development of the state. "Foresight-2017" Igor Sikorsky KPI project.

CONTENTS

PREAMBLE	10
UNIVERSITY SCIENCE OF UKRAINE: ON THE WAY FROM THE USSR TO EUROPE	13
1. AGRO-INDUSTRIAL COMPLEX AND BIOTECHNOLOGIES.....	19
1.1. Foresight: scenarios of socio-economic development of Ukraine up to 2020 and 2030.....	20
1.2. Electronic advisory system in the agricultural sphere of Ukraine	21
1.3. Hardware-software complex <i>LOTUS-1</i> for measuring main microclimatic characteristics in the vegetation cover	22
1.4. MV-5U Complex.....	23
1.5. Multifunctional immune regulator of plant growth	24
1.6. Application of Molybdenum nanoparticles colloid solution in chick-peas growing technology	25
1.7. Rotary oscillating granulator for nitrogen fertilizers melting	26
1.8. Vortex granulator for porous ammonium nitrate production	27
1.9. Biotechnology of methane and fertilizers production from hydrobionts	28
1.10. Modernization of cultivator <i>Maxim'</i> pantograph mechanism	29
1.11. Composite food supplement for quails	30
1.12. Method of reproduction and cultivation of valuable fish species.....	31
1.13. Application of the gas mixture for anaesthesia of sturgeon species in cultivating environment	32
1.14. New sheep breed – Prydniprovsk mutton sheep	33
1.15. Technology of Australian tropical crayfish rearing in the conditions of the South of Ukraine	34
1.16. Thermomechanical device with thermosyphons	35
1.17. Block grain dryer	36
1.18. Recuperative grain dryer	37
1.19. Household appliance for biogas production.....	38
1.20. Complex disinfectant preparation <i>Heocid</i> for sanitation of livestock enterprises premises	39
1.21. Portable device for non-metal surfaces sanitation	40
1.22. Application of biologically active substances of herbal origin for prevention of diseases, increasing the productivity and immunity of animals	41
1.23. Preparations for treatment and prevention and food supplements based on biologically active substances of humic origin.....	42
1.24. Method of intravital diagnostics of bovine leucosis with two-stage polymerase chain reaction.....	43
1.25. Method of intravital blood sampling of poultry	44
1.26. Method of simultaneous detection of both enterobacteria and neutrophilic fungi in bee pollen.....	45
1.27. Veterinary medicine “Membranostabil”	46
1.28. Application of electro-adhesive tissue fusion in veterinary medicine	47
1.29. Ozone therapy in veterinary surgery practice	48
1.30. Method of obtaining chicken egg yolk antibodies to aflatoxin b1	49
1.31. Method of canned meat toxicity evaluation	50
1.32. Detection of bacillary causative agents of poisoning and food spoilage	51
1.33. Production technologies of bakery products with improved quality and safety during production and storage.....	52

1.34. “Postponed baking” technology for bakery products of special purpose.....	53
1.35. Production technology of sugar confectionery with synbiotics	54
1.36. Technology of producing the diabetic fermented milk drinks	55
1.37. Innovative production of alcohol from raw starch.....	56
1.38. Biotechnology of organics recycling, using vermicomposting.....	57
1.39. Equipment for vibro-impact dehydration of food production wastes	58
1.40. Technology of obtaining the collagen from protein-containing wastes of leather production	59
1.41. Natural leather with the use of modern polymer materials	60
1.42. Leather manufacturing with the use of montmorillonite dispersions techniques	61
1.43. Composite coating for leather with high adhesive properties.....	62
1.44. Hydrophobized leather.....	63
2. SCIENCE FOR SECURITY AND DEFENCE	64
2.1. Unmanned aircraft system “Spectator”	65
2.2. Mobile unmanned aircraft system M-10 “Eye 2”	66
2.3. Polycopter NAU PK-08	67
2.4. Hybrid quadcopter	68
2.5. Unmanned loitering munition M-56 “Module”	69
2.6. Mobile unmanned aerial complex M-57 “Svitanok”	70
2.7. Technology of discrete strengthening of parts of special purpose machines.....	71
2.8. Combined technology for strengthening treatment of special-purpose items.....	72
2.9. Technology of missile radome machining using new construction materials.....	73
2.10. Digital coriolis vibratory gyroscope for stabilization and guidance systems.....	74
2.11. Special-purpose seismic vibration sensor	75
2.12. Component parts of micro-injector for radar equipment	76
2.13. Fire-resistant coating for building constructions of flammable and explosive substances storage buildings.....	77
2.14. Reinforced ceramic and metal-ceramic composites for application under extreme conditions	78
2.15. Small-arms fire visibility-reducing device	79
2.16. Multichannel smart odor-detecting device	80
2.17. New foods for mass and special consumption	81
2.18. Portable water purification plant “Sova”	82
2.19. Biometric-based system for complex assessment of operational and physical characteristics of combat kit	83
2.20. Men’s overalls for mechanized and armoured forces personnel.....	84
2.21. Protective overalls for aircraft rescue and firefighting services.....	85
2.22. Firefighter protective ensemble	86
2.23. Hospital gown for wounded military personnel	87
2.24. Knitted fabrics for personal protective equipment	88
2.25. Multilayer technical special-purpose textiles	89
2.26. Electroconductive fibrous material.....	90
2.27. Magnetic fibrous material.....	91
2.28. Composite EMF shielding paint	92

3. INFORMATION AND COMMUNICATION TECHNOLOGIES	93
3.1. Aircraft and machine-building manufacturing operations management	94
3.2. On-board signal processing device for “SICH-2M” spacecraft multispectral scanner	95
3.3. Portable tropospheric radio-relay station	96
3.4. Digital modem equipment based on SDR-technology for new generation tropospheric stations	97
3.5. Frequency filtration devices based on crystal-like structures	98
3.6. Broadband antenna for mobile communication means	99
3.7. Hectometric band antenna	100
3.8. Wireless sensor networks with self-organization for monitoring of environmental attributes.....	101
3.9. Decomposition method for determination of layered media structure and efficient radar cross-section of objects	102
3.10. Intelligence receiving system	103
3.11. Hardware and software system for non-destructive detection and recognition of underground objects	104
3.12. Noise-immune radio channels for information transmission.....	105
3.13. Information security devices on digital storages	106
3.14. Turbo decoding in information and communications systems	107
3.15. Laser vector system for image input-output	108
3.16. Information microprocessor-based system for diagnosis of material machining.....	109
3.17. Information system for the study of internal combustion engine operating processes	110
3.18. Systems of objects monitoring under dynamic loading conditions	111
4. NEW MATERIALS AND NANOTECHNOLOGIES	112
4.1. New method of quantitative determination of cationic surfactants in aqueous solutions	113
4.2. Piezoelectric and acousto-optic eco-friendly crystals	114
4.3. High-dispersed calcium-containing hexagonal ferrite powder	115
4.4. Modification of new materials for lead-free solders by nanoparticles	116
4.5. Technology of obtaining complex flux	117
4.6. Polystyrene composite scintillators	118
4.7. Containers and materials for the management of low and intermediate radioactive waste..	119
4.8. Nanodispersed powder materials for the elements of ceramic fuel cells.....	120
4.9. Cast porous metals for microcapillary heat pipes	121
4.10. Thermal grease	122
4.11. Non-combustible heat-insulating materials	123
4.12. Electrically conductive composite material	124
4.13. Material for thermocouple and thermal elements	125
4.14. Medium- and high-temperature greases for heavy duty sliding and rolling friction units	126
4.15. Obtaining wear-resistant composite material and microcomposite steels	127
4.16. Composite materials based on polymers for heavy loaded, heat-stressed material-polymer friction units.....	128
4.17. Innovative technologies of high-efficient functional coatings	129
4.18. Multilayer functional coatings	130
4.19. High-carbon wear-resistant coatings overlaying by using carbon fibre materials.....	131
4.20. Bulk and ribbon amorphous iron-based alloys doped with <i>d</i> -block elements	132

4.21. Supplementary Fe-Zn coating for strength improvement of steel products adhesive bonding with various application coatings	133
4.22. Technology of forming multilayer protective coating on the working surface of a cutting tool.....	134
4.23. Strengthening of surface coating made of metal alloys	135
4.24. Multi-functional cluster system for reactive ion-plasma synthesis of complex-composite compounds	136
4.25. Electrodeposition technology of MOS-8 and OS-12 alloys on plain bearing liners from electrolytes based on methanesulfonic acid	137
4.26. Non-fluorine pigment-free light-coloured enamel coating obtaining technology.....	138
5. POWER ENGINEERING AND ENERGY EFFICIENCY	139
5.1. Automated energy management system	140
5.2. Energetically balanced system of enterprise	141
5.3. Heating supply monitoring system of facilities.....	142
5.4. Energy active fences as a component of energy supply systems.....	143
5.5. Energy-efficient technologies of porcelain products for various purposes.....	144
5.6. Energy-efficient manufacturing technologies of high-strength fastening thread products	145
5.7. Energy-efficient furnace constructions for electrode products graphitizing	146
5.8. Extra-furnace processing technology of iron-carbon melts	147
5.9. Extra-furnace cast iron desuphurization by magnesium technology	148
5.10. Comprehensive assessment of life extension option of high-power steam turbines.....	149
5.11. Alternative fuels and reducing agents for metallurgical process.....	150
5.12. Improvement of energy efficiency of refrigeration equipment	151
5.13. Engine gas and diesel feed and adjustment system.....	152
5.14. Acoustic technology for yield increase in oil, gas condensate and water-supply well.....	153
5.15. Technology of power gas production for cogeneration units	154
5.16. Multipurpose jet-niche burners.....	155
5.17. Expansion turbines based on jet-reactive and vortex turbines.....	156
5.18. Jet thermal transformer for heat and cold supply systems	157
5.19. Heat-generating unit	158
5.20. Flexible photovoltaic solar energy converters	159
5.21. LED emergency lights	160
5.22. Lithium batteries with a long storage period	161
6. MECHANICAL ENGINEERING.....	162
6.1. Rotating submersible tuyere for ladle melt refining	163
6.2. Oxygen two-level tuyere for converter bath blasting and slag metal splashing	164
6.3. Multipurpose rotating skull shotcrete-tuyere	165
6.4. Conceptually new thermomolecular dampers-dissipators through the example of car shock absorbers	166
6.5. Resource-efficient technology of the multi-sided pipes production.....	167
6.6. Automated refrigeration unit providing possibilities for research and improvement of equipment energy characteristics	168
6.7. Tribotechnology of the wear-resistance increase of friction joints of machines and mechanisms	169
6.8. Unpolarized metal-oxide reference electrode.....	170

6.9. Multifunctional three-phase separator for oil treatment unit	171
6.10. Gas separator of inertial filtering type.....	172
6.11. Recycling units for noble gases reuse in knowledge-intensive industries.....	173
6.12. Bearing quality control system QCS-01	174
6.13. Magnetic pulse system for metalworking	175
6.14. Induction heating device for maintenance technologies	176
6.15. Multi-cylinder engine power supply system.....	177
6.16. High-efficiency screw pump.....	178
6.17. Counterbalance valve	179
6.18. Stop blocks for wheeled vehicles.....	180
7. INSTRUMENT ENGINEERING	181
7.1. Nanosatellite PolyTAN-2-SAU of Igor Sikorsky KPI in the international project QB50.....	182
7.2. Satellite telescope of electrons and protons "STEP-F"	183
7.3. Hardware and software facilities of integrated inertial and satellite navigation system for unmanned aerial vehicles	184
7.4. Forward flow sensor in the system for deorbiting space objects from low near-Earth orbits	185
7.5. Complex gas-aerosol polarization holographic lidar	186
7.6. Thunderstorm warning system.....	187
7.7. Digital holographic interference microscope	188
7.8. Non-contact optical three-dimensional profilometer	189
7.9. Friction and wear testing machine ASK-01	190
7.10. Instrument for measuring physical and mechanical properties of materials by depth sensing indentation and scratch testing techniques.....	191
7.11. Hydro-impulse devices for vibration turning and strain hardening	192
7.12. Stand for surface cleaning forces measurement	193
7.13. Universal defectoscope for quality control of low-conductive layers.....	194
7.14. Universal piezorezonant instrument for granular materials moisture measurement.....	195
7.15. Express method for coal ash content determination	196
7.16. Gas analyser of natural gas	197
7.17. Book block back preparation device for perfect binding.....	198
7.18. Technology and machine for package decoration by flocking	199
7.19. Multi-layer X-ray mirrors	200
7.20. Ion-beam sputtering system	201
7.21. Compact device for ion-plasma processing of micro- and nanostructures "Titan II"	202
7.22. Source of combined ionic-electron beam with full current compensation	203
7.23. Test device for supercapacitors parameters' measurement	204
7.24. Beam-controlled semiconductor resonator	205
8. BUILDING TECHNOLOGIES AND VEHICLES	206
8.1. Bundled reinforcing steel bars with the strength index 600 mpa for the ferro-concrete frames	207
8.2. Resource-efficient technology of facade ceramic materials production	208
8.3. Technology of manufacture of fiberglass products with various transversal-isotropic structure.....	209
8.4. Innovative products made from forest residues.....	210
8.5. Super fast-curing alkali cement and concrete based on it	211

8.6. Alkali cement as effective materials of radioactive materials' utilization.....	212
8.7. High-melting compound-based special cements and concrete	213
8.8. High strength stone mastic asphalts.....	214
8.9. Bituminous binders cohesion density measurer	215
8.10. Road surface wheel tracking measurement device.....	216
8.11. Laser calibration system	217
8.12. Soil sampling plant with the possibility of correcting the trajectory of soil sampling working body	218
8.13. Technology and equipment for thermal reinforcement of stamped-welded junction pieces for magistral pipelines.....	219
8.14. Coaxial-line engine with permanent magnets serving as an actuating device of construction plants and oscillating mechanisms	220
8.15. Collapsible track wheeled pair 1435/1520	221
8.16. Dust concentration frequency meter (DCFM-2).....	222
8.17. Twin-engined unmanned aircraft M-7V5 "Nebesniy Patrul"	223
8.18. Multiengine ummaned helicopter for cargo transportation PKM-14 «Saturnia».....	224
8.19. Multi mission double engined convertiplane NAU-KM 3 "Kubok"	225
8.20. Multipurpose drone with automatic identification of objects on the terrain.....	226
8.21. Multi mission unmanned aerial complex M-6-3 "Zhayvir"	227
8.22. Unmanned airplane with whirl generators on the wing and control panel.....	228
8.23. Training unmanned aircraft M-22d "Aerotester"	229
9. HEALTHCARE	230
9.1. Method of assessment of the impact of electromagnetic-field and hazardous substances on humans	231
9.2. Cellular biosensor for diagnosis of human autoimmune pathologies.....	232
9.3. Device for identification of ligand forms of whole blood hemoglobin for instant diagnosis of critical condition	233
9.4. Optoelectronic complex for identifying the state the peripheral circulation	234
9.5. Computing system for pre-surgical heterotopia planning	235
9.6. Holographic maculostimulator	236
9.7. Holographic visocontrastometr	237
9.8. Hardware-software complex for braille images evaluation	238
9.9. Method of modification of magnetite surface with nanoparticles	239
9.10. Pulse sterilizer for refining the objects of different nature by using the high-intensity electromagnetic impulses	240
9.11. Polypropylene surgical bactericidal monofilaments	241
9.12. Multifunctional hardware "Barva -Therapist"	242
9.13. Digital pulse recorder of high-probability registration of pressure pulse	243
9.14. Magnetic impulse treatment apparatus "MILA – 1":	244
9.15. Natural antioxidants and glycosaminoglycan composites as neuroprotectant, and neuroregeneration stimulators.....	245
9.16. Multi-layered transdermic treatment wraps.....	246
9.17. Hemostasis treatment	247
9.18. Dried hydrogel treatment dressing	248
9.19. Barrier surgical ensembles for cross contamination protection	249
9.20. Special danger infection protective ensembles.....	250
9.21. Suit for people with spinal injury	251
9.22. Massage insoles and shoes	252

10. ENVIRONMENT MANAGEMENT	253
10.1. Technology of creating DSS (decision support system) for integrated water resources management of the river basin or region.....	254
10.2. Implementation of innovative technologies of biomelioration on water bodies of general use for increasing quality of water resources in Ukraine	255
10.3. Pyrolysis plant for wastes recycling	256
10.4. Food industry wastes utilization	257
10.5. Biosorption and filtration technology of waste water treatment.....	258
10.6. Technology of wastewater sludge stabilizing.....	259
10.7. Adsorbents for industrial water and oils treatment.....	260
10.8. Environmentally friendly jet fuels.....	261
10.9. Innovative scheme of controlling of microbiological contamination and biological stability of aviation fuels and materials	262
10.10. Advanced technologies for the processing of technical vegetable oil in fuel- lubricating materials	263
10.11. Enviromentally-friendly technology of microcrystalline cellulose production from domestic non-wood plant raw material	264
10.12. High-speed methane concentration meter for underground air of coal mines.....	265
10.13. Explosion suppression system	266
10.14. Energy-condensed granular system “Ukrayinit-ANFO” for the replacement of trotyl in the destruction of rocks	267
10.15. Resource saving methods of underground space management	268
AFTERWORD	269

PREAMBLE

Special mission of science at higher education institutions is multifaceted. Firstly, it is to teach students at a high quality level. Joining their lecturers in the process of scientific research they gain the opportunity to develop as researchers. The level of their skills and knowledge is determined annually during the All-Ukrainian competition of students' scientific works in natural, technical and liberal sciences. In 2017 the competition was won by 1888 students from 234 higher education institutions. **The most promising students** further develop their scientific gifts obtaining **their Master's and PhD degrees while studying at second and third cycle of higher education accordingly.**

Secondly, production of new scientific knowledge by the lecturers of the university is a constant source of the education contents' renewal via formation of new subjects, application of the acquired results in the laboratory works and practices modernization, creation of new textbooks and workbooks for the contemporary specialties, which actually appear on the basis of newly received knowledge. **New scientific knowledge, obtained by teachers, is the essence of their Qualifying Theses,** successful defence of which provides the possibilities to get their degree of the Candidate of Sciences (Doctor of Philosophy) and then academic titles of the Associate Professors and Professors. It is the university environment where over 80 % of Doctors of Sciences and Candidates of Sciences (PhDs) are successfully trained. The recent years have shown a clear tendency of growth of the universities share in this process. Many universities have established a good tradition **of formation and successful activity of scientific schools,** the main characteristic of which is, namely, the presence of 3 generations of scientists in particular scientific fields i.e. the founder of the school – his/her disciples – apprentices of the disciples.

Thirdly, the highest form of organizing the science in the universities is the **formation of scientific environments,** engaging teachers, staff of the scientific departments, post-graduates and students that not only obtain new scientific knowledge, but also use them to develop **new technologies, samples of new products** in order to accelerate the development, production and implementation of the cutting-edge high-tech products, transfer of technologies to domestic and foreign markets.

The Ukrainian science is successful and scientific and pedagogical community of the higher educational establishments has huge potential that clearly proves its significance for solving the problems of the state and this is also honoured at the level of the state. For example, 10 out of 13 research projects awarded with **the State Prize of Ukraine in Science and Technology in 2016,** were done with the direct involvement of **38 scientists from higher education institutions (out of 98 new award winners).** The awarded research projects were almost completely done in the university environments, for example in V. N. Karazin Kharkiv National University.

The results of distribution **of the President's awards for young scientists** are also outstanding and newsworthy. Almost half of the awarded research projects (18 out of 40) were done at universities, and the number of laureats of the President's awards for young

scientists representing higher education institutions (52) constitutes the majority of all (94) awarded scientists. **Thus, the remarkable tendency to further increase the significant scientific achievements is observed.**

Consequently, there is every reason to say that **under contemporary difficult conditions of establishing and securing independence of our state the university science successfully contributes to address the needs of Ukraine.** That's why the Board of the Council of the Vice-rectors for Science and Research has resolved on the expedience and publishing of the compendium "Innovations of the universities and scientific institutions of the Ministry of Education and Science of Ukraine", on the 21st of March 2016. The term «**innovation**» shall be defined as a **result of completed research and development work or independently initiated research in a form of newly made and/or improved competitive technology, product or service that substantially enhances the structure and quality of production and/or social sphere, and which is protected as an intellectual property object or is subjected to the license agreement as a know-how.**

On consideration of the suggestions of the vice-rectors the task force of M.V. Strikha, M. Yu. Ilchenko, V.V. Kaplun, S.V. Pavlov and V.V. Otchenashko organized by the resolution of the Council of the Vice-rectors for Science and Research, has resolved on the structure of the publication and the required format of information to be provided about the innovations. The approved format envisages that the information about each innovation should include: the title of the university or scientific institution where it was designed, the title of the innovation, the essence of the innovation and its main characteristics, the advantages of development, the state of intellectual property protection, the market demand for the innovation and its readiness for implementation, images of the developments and the contacts available for communication with the corresponding department of higher educational establishment or scientific institution.

This compendium is opened with the instructive foreword of **the Deputy Minister of Education and Science of Ukraine M.V. Strikha concerning the state of organization and funding of the university science** and reflections of the upcoming implementation measures related to the Law of Ukraine "On Science and Scientific and Technology Activities". The main content of the compendium is the information about 240 innovations, provided by the universities and scientific institutions. The task force selected these innovations of 30 universities out of over 400 R&D products according to the results of the expert assessment of their conformity to the established format. The viable information was thematically structured and divided as follows: agricultural sector and biotechnologies, scientific support of security and defence, information and communication technologies, new materials and nanotechnologies, energy supplies and energy efficiency, mechanical engineering, instrument engineering, construction technologies and transportation, health care, reasonable use of natural resources.

It should be mentioned that the approved structuring of the compendium correlates with the results of the foresight research headed by the Rector of National Technical University of Ukraine "Igor Sikorsky Kyiv Polytechnic Institute", Full Member of the National

Academy of Sciences of Ukraine M.Z. Zgurovsky, which has highlighted **nine clusters of domestic economy, which may make Ukraine interesting enough to integrate into the international cooperation**: agricultural complex, military industrial complex, information and communication technologies, nanotechnologies and creation of new substances and materials, green energy, high tech mechanical engineering, development of transit infrastructure, science about life, tourism. Thus, scientific innovations of higher education institutions correspond to promising directions of domestic economy.

The information announced on the 15th of November during the meeting of Committee on Science and Education of the Verkhovna Rada of Ukraine has confirmed the direction of university science towards solution of the urgent problems of strengthening the defence and security of the country. According to this information, the database of Defence department nowadays includes over 400 R&D projects, which surpasses the similar rate of NASU institutes.

The concluding part of the compendium contains the information concerning the best experience of certain universities in issues related to organizing of innovative activities, the presence of universities' or scientific institutions' structures and departments working on R&D projects commercialization (science parks, clusters, business incubators etc.).

The work team involved in preparation of this compendium expresses sincere gratitude to all heads of scientific departments at the universities and scientific institutions for provision the information about the R&D projects. At the same time, we hope that this information about the obtained experience and innovations at higher education institutions will familiarize the community with **scientific developments, thus encouraging the formation of pertinent evaluation of science at the universities among the states' executive bodies and community.**

MYKHAYLO ILCHENKO,
Head of the Council of the Vice-Rectors for Science
and Research of the Higher Education Institutions and
the Directors of the Scientific Institutions of the
Ministry of Education and Science of Ukraine,
Full Member of the National Academy of Sciences of Ukraine

UNIVERSITY SCIENCE OF UKRAINE: ON THE WAY FROM THE USSR TO EUROPE

The key task of Ukrainian R&D system reforming, outlined by the new law “On Science and Scientific and Technology Activities” adopted at the end of 2015, is to change the approach to research and innovations and publishing (or implementation) of their results, to achieve the quality of scientific content, to justify the results, harmonize them with global scientific achievements and ensure their competitiveness. The realization of this ambitious goal is hindered by various obstacles of both objective (limited financial resources of the country that is de-facto in the state of war) and subjective (the resistance of the system, which has been established for decades and has no intention to change despite obvious and drastic changes of external circumstances) nature.

In the times of the former USSR “excellent science” was considered to be done in the institutes of the Academies of sciences, and the applied R&D projects were developed in various specialized engineering bureaus and so-called “boxes” (the title clearly reflects the secrecy level of operation, at which the institutions had only numbers of letter boxes instead of real addresses). The priority task set by the ruling communist party for the universities and institutes was to train new specialists. Thus, the science was considered there to be subordinate and not obligatory. Science of higher education institutions was not funded from the state budget of the USSR, so the universities had to show the miracles of resourcefulness to conclude economic contracts with industrial enterprises (the acquired skills stood in good stead for the university scientists in the new era, marked with stronger dynamics and fight for survival).

Ukraine has been in a long search of the best model for its scientific system. In the Soviet times the Academy of Sciences of Ukraine became an important part of economic complex and successfully took the functions of the “industrial” science, unlike similar institutions in other republics. But its organization structure and operation principles haven’t changed significantly since 1980s. Only dozens out of hundreds of formerly powerful “sectoral” boxes and engineering bureaus remained active. Meanwhile since mid-1990 there have been heated discussions whether Ukraine should follow the way of those western countries, where science is mainly concentrated at the universities.

Those who support the traditional model of “academies-centered system” may reasonably argue that there are numerous successful examples of non-university science in the West e.g., national laboratories in the USA, CNRS in France, Max Planck and Fraunhofer Societies in Germany etc. The compromise solution adopted by Ukraine has therefore been to preserve the system of national academies, and at the same time to recognize the universities as equal players on a scientific field at the legislative level. Besides, the newly adopted in 2014 Law “On higher education” proclaimed the scientific function of universities as important as the educational one.

But there is a long way for something that has been declared to go before it’s put into action. Almost two decades ago independent Ukraine started **budget for the university science, but through competitive funding only, provided that relatively short-term 2-3-years**

research projects were supported. On the one hand it made the university scientists more dynamic comparing to their colleagues from the NAS and sectoral (agrarian, medical etc.) academies. On the other hand, the only failed competition threatened the R&D activity of the whole university with a complete downfall. The funding for this competition was also much lesser than for the basic support of the scientific institutions of the academies. For a long period, the share of the Ministry of Education and Science varies within 10% of the total amount of the state funds allocated to the science. To fairly estimate these figures it should be kept in mind that Ministry of Education and Science provides part of this amount to support the aforementioned academies (to pay for the membership in international organizations, to support bilateral research projects, to pay for the development of technological innovations under the State Procurement). At the same time the number of educational-research and scientific staff involved in R&D at higher education institutions, is approximately twice the number of the scientists employed by NAS and 5 sectoral academies taken together.

Even from the mentioned above it becomes clear that despite so-called equality proclaimed by the law, the university science of Ukraine is de-facto discriminated if compared with the state support of science in NASU and “sectoral” academies (which, in its turn has good reasons to complain on the lack of funds).

Nevertheless, the university science still exists and finds the opportunities for further development. Let me try to prove this with some figures. 166 higher education institutions and scientific institutions, subordinate to the Ministry of Education and Science in 2016, did the whole spectrum of research ranging from Philology and Astrophysics to Art History and Medicine. To fund them as well as to provide them with the opportunities to participate in scientific events being involved in the European and global integration processes the Ministry of Education and Science was provided with **841,5 million UAH** allocated to “Science” from the total fund of the State budget in 2016. At the same time the aggregate value of the thematic plan of higher education institutions and scientific institutions of the Ministry of Education and Science of Ukraine, i.e., the works funded as the winners of competition, constituted **442216,2 thousand UAH**, thus slightly exceeding half of the abovementioned amount. The Ministry of Education and Science spent the balance of “scientific” funding on support of the academies and “sectoral” science via the aforementioned mechanisms and competitions.

Let us also consider another interesting fact: the specials funds received i.e. the funds for scientific activity, earned by the universities themselves in 2016, exceeded **316,5 million UAH** as reported by the State Treasury of Ukraine. With this indicator (75 earned kopiykas per 1 UAH from the general fund) the universities outpace all other “major players” in our scientific field, demonstrating stunning abilities to earn money even under current challenging conditions.

Last year’s 50% increase in funding of the university science from the general fund should be considered a substantial achievement in today’s circumstances if compared to the extremely difficult year of 2015. But if we represent these figures in hard currency there will not be reasons for happiness, because in reality the funding of the university science has

decreased dramatically in the recent decade: **2007–73,4 million USD (366694 thousand UAH), 2012–55,3 million USD (442707,8 thousand UAH), 2016–32,4 million USD.** And while the salaries of scientists are paid in UAH, modern scientific equipment vitally important for the contemporary science is purchased in USD and EUR (a great deal of powerful equipment of our own production has been thoughtlessly destroyed during the first two decades of independence, and now, for example, all that is left to us is only to regret about those excellent electronic microscopes from Sumy).

Prestige of scientific activity is an obligatory prerequisite of competitive scientific results. However, along with the increase in the absolute figures of the salaries of university scientists, their real purchasing power is decreasing. The salary of the scientific employee in 2007 constituted 1925 UAH (385 USD), in 2012 – 3265 UAH (408 USD), and in 2016 – 6690 UAH (approximately 260 USD).

Against this background it is only the approximate 5% increase in number of young scientists in 2016 that inspires optimism. That was mostly due to the “competition for the young scientists” initiated by the Ministry of Education and Science of Ukraine that year and participated by 79 competitors presenting their scientific and R&D projects. In 2016 the amount of 12129,4 thousand UAH was spent on the R&Ds of the young scientists. In 2017 such funding was substantially increased in 2017. The ongoing studies got funding amounting 30146,4 thousand UAH (including 3650 thousand UAH as capital expenditures). While the winners of the competition 2017 will receive 13 million UAH by 123 scientific topics, in 2018 the funding of “young” science is expected to reach almost 15% of the scientific budget of the Ministry of Education and Science of Ukraine. That’s the first large-scale appeal made by the state to the young scientists: stay, the situation in Ukrainian science is not hopeless!

Despite the inevitable trend decline in scientific personnel caused by such poor funding in the year 2016 almost 12 thousand of employees were involved in R&D projects within the system of Ministry of Education and Science (4,4 thousand of them were full-time employees). This number added with the majority of 81 thousand of educational-research employees, doing their scientific research and making innovations “in the afternoons”, along with students, post-graduates and doctoral students makes Ministry of Education and Science of Ukraine the unquestionable Ukrainian leader by the number of people involved in scientific activities.

In 2016 general funding was provided from the budget to 1497 research projects including 704 fundamental and 793 applied and scientific and technical research. Those projects were aimed at current priority directions of science and technology as well as at the scientific fields prioritized by each university.

The higher education institutions (classic, technical, technological, construction, pedagogical etc.) are significantly diverse in the specificity of their scientific performance, while scientific institutions of the Ministry of Education and Science represent different fields of science ranging from the Ukrainian studies to the artificial intelligence research. The subjects of their research projects are also very diverse comprising 318 research areas in all fields of science. The cost of the research also varies being under 80 thousand UAH (47 R&Ds costing 3010 thousand UAH), 80–120 thousand UAH (280 R&Ds costing 27386 thousand UAH),

120–500 thousand UAH (984 R&D costing 222393 thousand UAH), 500–1000 thousand UAH (120 R&Ds costing 82717 thousand UAH), 1000–3000 thousand UAH (61 R&Ds costing 88648 thousand UAH), over 3000 thousand UAH (5 R&Ds costing 18062 thousand UAH). The price of work is determined by a set of factors including the field of science, presence/cost of equipment, number of people involved, prices for reagents and other materials.

In 2016 higher education institutions and scientific institutions of the Ministry of Education and Science completed 256 fundamental research projects, 462 applied research projects, 28 science and technical projects, as well as 5186 projects ordered by the industrial sector and business entities. Over two thirds of the total number of the results were implemented in production or became widely used otherwise. Thus, in 2016 higher education institutions and scientific institutions received 4397 documents of title (including 873 mechanical patents, 13 of which were received abroad), sold 49 licenses, issued 1792 monographs, published 8206 articles in journals, peer-reviewed in such scientometrical databases as Scopus, Web of Science and Index Copernicus (the latter being only for the liberal arts provided with facilitated conditions for the transition period), 125 thousand articles were published in specialized journals of Ukraine.

Higher education institutions and scientific institutions of the Ministry of Education and Science of Ukraine are actively developing such scientific research directions as radiation and medical physics, biophysics, spintronics, materials science, ICT, mechanical and instrumentation engineering, mining technologies, agricultural and food technologies, R&Ds aimed at enhancing the defensive potential and security (and this list is far from complete). For three subsequent years the thematic research plans of the universities and scientific institutions have included the R&D projects preliminary analysed by Central Scientific Research Institute for Armament and Military Equipment of the Armed Forces of Ukraine in terms of their importance for the security of the state. Only in 2016 there were 54 projects funded with 36839,4 thousand UAH. Such projects increase annually in number and extent (in 2015 there were only 28 projects the aggregate cost of which constituted 12249,2 thousand UAH). Scientific results these projects, were implemented at enterprises, namely the State Concern “UkrOboronProm”.

Another confirmation of the applied direction and significance of the results obtained by the universities scientists is the fact that the majority of our leading universities are members of consortiums, performing projects under “Horizon 2020”, the EU Program for Research and Innovations (in October 2017 the Program supported 117 projects participated by Ukraine with share of **17232 thousand EUR**).

In 2016 the scientists of higher education institutions actively participated in bilateral scientific cooperation projects under inter-governmental agreements, being involved in 20 scientific projects in 12 countries of the world with the total funding of 1055,8 thousand UAH. The positive dynamics is noteworthy, because 2017 showed the increase to 40 projects totally funded with 4305,5 thousand UAH. Consequently, the success of university science in the international arena is clearly observed. This is also proved by the funding amounting to 62488,4 thousand UAH transferred to the accounts of the higher education institutions and scientific institutions. However, the amount of such funds would have been significantly

larger if it hadn't been for obstacles set by the budget law of Ukraine. The foreign partners are well aware of such obstacles being reasonably fearful of them.

In 2018 Ministry of Education and Science is anticipating a positive effect of the access to Scopus and Web of Science databases obtained by over a hundred of leading higher education institutions and scientific institutions as a result of competition held at the end of 2017. The value of this step taken by Ministry of Education and Science goes far beyond the university sector because now every scientist in every regional centre may be provided not only with the required scientometrics, but also with significant facilitation in determining the prospects of chosen research direction, searching of possible partners and forming of own research strategy.

The lack of modern innovative system efficiently connecting the researcher's laboratory with real economy remains one of the most painful problems for Ukraine. But again it is the universities that are our success stories and this fact is proved with the aforementioned indicator of 75 kopiyykas earned per 1 budget hryvnya. Successful experience of Igor Sikorsky Kyiv Polytechnic Institute, the start-ups of which can boast with tens of millions of invested hryvnias is widely known. The Science Park of Taras Shevchenko National University of Kyiv is also steadily growing. The innovative experience of Sumy State University also deserves the greatest possible respect. Numerous other examples can be made. The Council of the Vice-rectors for Science and Research initiated preparation of this compendium containing the information about 240 cutting-edge technological innovations ready for real implementation in various fields of science, represented by 30 universities.

And now let's talk about the future. Ministry of Education and Science will continue to improve the mechanisms of competitive funding of the universities research projects (by the way, having audited the scientific-innovative system of Ukraine under "Horizon 2020" Program instruments the European experts recognized such competition as transparent and open). This competition has proved its reliability as a real mechanism of receiving the state support for every active scientific team (even from regional and not widely known university).

However, at the same time if we are really trying to implement the European mechanisms of scientific sphere funding, we should bear in mind that over 2/3 of scientific research funding at German universities (and over 5/6 at Dutch ones) is the institutional (or basic, as we call it in Ukraine) funding; while the project (or grant) funding constitutes substantial minority. It is such correlation (2/3 of institutional and 1/3 of a project funding) that actually provides the balance of dynamics and stability optimal for any national scientific system.

The scientific community of Ukraine still focuses its attention on the National Research Fund of Ukraine established to provide the efficient mechanisms of grant funding of projects of the academic institutions, higher education institutions and individual scientists. But in reality the implementation of basic funding of the university science, envisaged by the Law "On Science and Scientific and Technology Activities", deserves equal attention. Doing without it we will never overcome the abovementioned discrimination actually faced by the university science and, consequently, we won't be able to turn our scientific landscape into a truly European one!

In fact, it is not easy task to implement such model of funding. The politicians are currently reluctant to provide funds sufficient to satisfy the needs and ambitions of all university scientists. At the same time spreading the funds “too thin” trying to provide something for everybody won’t yield any noticeable (let alone ground-breaking) results.

It is obvious that basic funding should be obtained by the best and the most effective scientists. But measuring the scientific efficiency of a big classic university, where (as opposed to a lean scientific institution) a diverse range of the research directions exist may resemble the well-known process of measuring the average temperature of the hospital patients including those who are the late. That’s why all previous attempts to implement impartial system of ranking universities by their scientific level were of no avail.

But there is a way out, also based on the European experience: to assess the universities **research directions** above all. The oncoming attestation of higher education institutions is planned to primarily assess such research directions in terms of scientific activity (also envisaged by the Law “On Science and Scientific and Technology Activities”). Reputable experts (preferably the foreign ones) on the basis of objective figures of efficiency of the research direction for the previous 5 years and its current potential (both human and material resources), scientific report for the aforementioned period and planned development for the following 5 years will decide on which research directions will constitute the group of leaders receiving the basic funding as a priority, which of them are the strong average performers, and which of them are more significant for the educational activity of the university and consequently can’t apply for scientific funding. At the same time the scientific teams will always have the possibility to apply for the funding in the Ministry of Education and Science competition with well-elaborated mechanisms as well as in the competitions initiated by the newly established **National Research Fund of Ukraine** and under the international projects.

The report, prepared for European Commission in 2016, states that the majority of EU members have started the initiatives the main goal of which was to implement measures that will improve the results of research and concentrate the resources in the most effective organizations. Thus, the implementation of basic funding for higher education institutions is deemed not to be an uncontrollable process of money “shuffling” but an innovation, preceded by serious preliminary actions. Only such approach can bring notable result for the development of the university science providing efficient utilization of the budgetary funds.

Nowadays Ukrainian science is on the verge of important changes. The Scientific Committee of the National Council for Science and Technology provides the preparation of a regulatory framework for the operation of the **National Research Fund of Ukraine**. But it will be equally important to implement the European system of supporting the scientific research at the universities, which will flexibly combine basic (actually based on 5 year institutional grants) and competitive funding. Only these two initiatives implemented together will be able to bring our scientific landscape closer to the European standards.

MAKSYM STRIKHA,
Deputy Minister of Education and Science of Ukraine,
Professor, Dr. Sci. in Physics and Mathematics

1. Agro-industrial complex and biotechnologies





FORESIGHT: SCENARIOS OF SOCIO-ECONOMIC DEVELOPMENT OF UKRAINE UP TO 2020 AND 2030

Purpose of invention

The foresight of complex socio-economic systems' behaviour (of the country, region or city) with the view to design scenarios of their development; support during adoption of managerial decisions through defining of desirable scenarios of the socio-economic systems development and ways of their implementation

Key benefits of innovation

The proposed methodology for predicting complex socio-economic systems behaviour is universal in its basis and nationally oriented in its applied aspects. In contrast to existing approaches, it provides an opportunity to explore specific national problems taking into consideration the need to ensure the sustainable development of Ukrainian regions under the influence of multiple threats and risks

Essence of invention

The methodology has been developed and the complex of works has been conducted on the foresight of socio-economic development of Ukraine in the mid-term (until 2020) and long-term (till 2030) time horizons. There have been defined 5 main impeding factors of the Ukrainian economy, 10 drivers (clusters) of accelerated development of the Ukrainian economy (see the cover of the compendium) and 8 other important foresight operators. There has been performed the assessment of the available human resources, capable of performing the desired transformation in the country. There have been developed 8 scenarios of the socio-economic development of Ukraine for the medium (up to 2020) and long-term (till 2030) time horizons. Fifty main actions of the authorities have been formulated in the form of a strategy of socio-economic development of Ukraine in the medium and long-term time horizons. An online platform for simulation and visualization of the strategy of social and economic development of Ukraine has been proposed

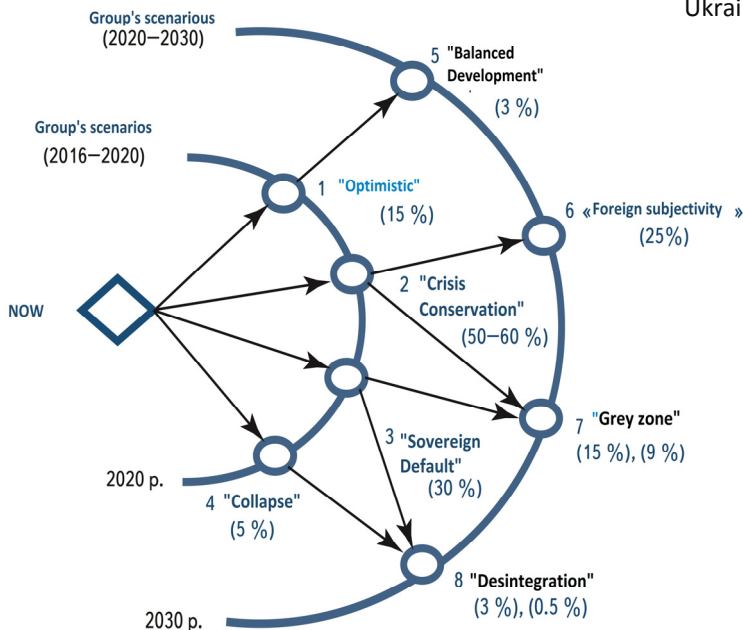

Market demand

The obtained results can be used by decision-makers at the domestic level, by civil society institutions and international organizations to develop rational policy and constructive plans of socio-economic development of Ukraine in the medium and long-term time perspective

Standby status

The innovation is ready for implementation

Department of Intellectual Property and Commercialization of R&D Products

37, Peremohy ave., Kyiv 03056, Ukraine

email: patent@kpi.ua, <https://www.kpi.ua>, telephone/fax: +38(044) 236-40-56



ELECTRONIC ADVISORY SYSTEM IN THE AGRICULTURAL SPHERE OF UKRAINE

Purpose of invention and sphere of application

The electronic advisory system is designed to provide counselling services and training of agricultural manufacturer and also for informational support of rural population on the basis of sustainable development

Intellectual property protection status

The registration certificate of copyright for the invention was obtained

Essence of invention

The electronic advisory system in the agricultural sector of Ukraine is an electronic platform with wide web service capabilities for the dissemination of agricultural data and knowledge, operational counselling of agricultural manufacturers and distance learning, advanced training and certification of agricultural production specialists

Market demand

The electronic advisory system can be used by advisory departments, agricultural universities and research institutions, non-governmental and professional organizations of Ukraine for the dissemination of agricultural knowledge and specialized training

Key benefits of the innovation

There is no similar electronic advisory system in the Ukrainian segment of the internet. The system's mechanisms of providing users with the necessary information are constantly developing and improving

Standby status

The electronic advisory system is located in the Ukrainian segment of the internet at www.edorada.org and can already be used for advisory services and consulting in the agricultural sector and in the scientific and educational process

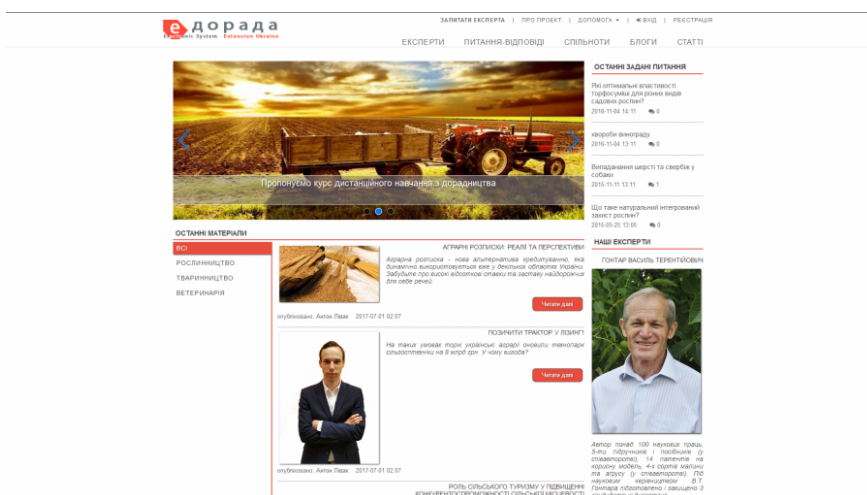

R&D Department

15, Heroiv Oborony str., Kyiv 03041, Ukraine
 email: org_section@nubip.edu.ua, <https://nubip.edu.ua/about>, Tel./fax: +38(044) 527-85-89



HARDWARE- SOFTWARE COMPLEX *LOTUS-1* FOR MEASURING MAIN MICROCLIMATIC CHARACTERISTICS IN THE VEGETATION COVER

Purpose of invention

The invented complex is intended for operative measurement of microclimatic characteristics of vegetation (air temperature and humidity, the intensity of direct and reflected solar radiation) in different layers of vegetation cover

Market demand

The demand in the market of environmental and agricultural research is extremely high. The innovation is used to assess changes in the environmental conditions of vegetation and microclimatic changes depending on the environmental conditions

Essence of invention

The device utilizes the technology of connecting temperature, humidity and illumination sensors, through the 1-Wire protocol with the fixation of the obtained results. Aosong Electronics chipset DHT22 is used as temperature and humidity sensors. The manufacturer ensures an absolute measurement error of not more than $\pm 0,5^{\circ}\text{C}$ for the temperature range from -10 to $+85^{\circ}\text{C}$. The microchips MAX 44009 manufactured by "Maxim" are used as the most advanced to measure the lighting conditions. The microchips convert the temperature, humidity and lighting measurements into a digital code, do not require any calibration and can be used at the temperature from -40 to $+85^{\circ}\text{C}$

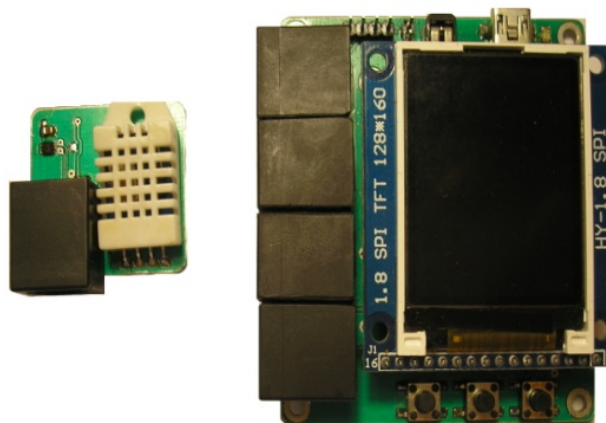

Intellectual property protection status

Documents for obtaining patent of Ukraine are being prepared

Standby status

An experimental prototype has been manufactured, the basic circuit arrangements have been worked through and actual testing has confirmed the expected properties

Department of Scientific and Technical Information

1, Kosmonavta Komarova ave., Kyiv 03058, Ukraine
email: vtnik@nau.edu.ua, <http://nau.edu.ua>, Tel/fax: +38(044) 406-71-56; +38(044) 406-79-21



MV-5U COMPLEX

Purpose of invention and sphere of application

The usage of autonomous aircraft to solve various problems is of a great importance today. The application of such instruments in the agricultural sector to diagnose the state of crops is particularly appropriate. Prospective fields of MV-5U complex application are: observation over the state of plants in agricultural fields; mapping of a given area; the object monitoring; construction of a 3D terrain model of a given area; inspection of public dumps locations; construction and validation of large-scale buildings; search and rescue operations

Essence of invention

The invented complex uses modern high-precision MEMS technologies, GPS satnav system, high-resolution multispectral camera, ergonomic and intuitive interface. The software works with a modern innovative MultiSpectral camera Parrot Sequoia. The software product includes a tracing panel of a given testing site for orthophotogrammetric survey, a setup panel for a multispectral camera, and a display panel for small autonomous aircraft flight parameters

Key benefits of the innovation

Unlike similar mechanisms the complex is simple to operate and has low cost-price, which enables its usage not only in the domestic but also in the world market

Intellectual property protection status

An application for the patent of Ukraine has been submitted

Market demand

The innovation demand is stipulated by the fact that nowadays not all agricultural companies can afford to purchase a full-featured unmanned vehicle for the analysis of the fields condition due to the need of personnel training and high price of service

Standby status

Ground station control software – 75%; aircraft software – 75%; aircraft avionics – 80%

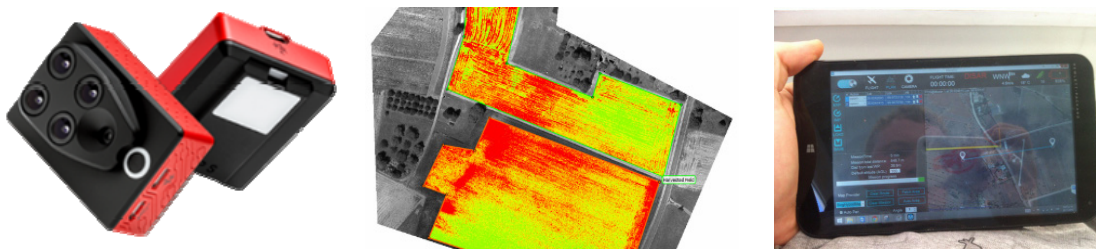

An example of a processed orthophotograph obtained from the camera shots; an image of the software

R&D Department

17, Chkalova str., Kharkiv 61070, Ukraine
email: khai@khai.edu, [http:// www.khai.edu](http://www.khai.edu), Tel: +38(057) 788-45-62; fax: +38(057) 788-48-55



MULTIFUNCTIONAL IMMUNE REGULATOR OF PLANT GROWTH

Purpose of invention and sphere of application

The innovation is designed to stimulate the growth and development of plants, increase the resistance to unfavourable environmental conditions and also improve yield and viability of agricultural plants. It is used for the rootage of fruit, berry, ornamental and flower crops, the acceleration of root formation in the process of cutting and the improvement of vegetable and flower crops seedlings ability to acclimatize during replantation

Essence of invention

Multifunctional immune regulator of growth is based on synthetic compounds. It contains a full range of microelements in the form of complex compounds, which are beneficial for plants if used in the chelated form, and is a mixture of white and gray crystals. Action spectrum: it increases the seed germination similarity and energy; stimulates growth; accelerates the development of plants; stimulates root formation; provides active sprouting; improves the survival rate of seedlings, nurslings and saplings during replantation; increases the yield of different crops by 10-25% or more; improves the quality of the grown products; shortens the ripening period for 10-15 days; increases plant immunity and is effective as antistressant and adaptogen; increases plant resistance to unfavourable environmental conditions; suppresses pathogenic microflora, protecting plants from bacterial and fungal diseases; increases the efficiency of mineral fertilizers and pesticides, reducing their application amount by 20-30%

Intellectual property protection status

6 patents of Ukraine for the utility model have been obtained

Key benefits of invention

The invention differs from other industrial stimulants in its higher biological activity, the peculiarities of molecules structure, and the usage of a unique complex of biologically active substances. The original technology of the drug production and thorough control of its compliance allows receiving a stimulant which effectiveness exceeds all the analogues known

Market demand

The initial capacity of the market is 300-600 thousand hectares

Standby status

Full-scale production



R&D Department

23, Sritenska Str., Kherson 73006, Ukraine
email: shabaev_o@ksau.ks.ua, [http:// www.ksau.kherson.ua](http://www.ksau.kherson.ua), Tel/fax: +38(0552) 41-75-92



APPLICATION OF MOLYBDENUM NANOPARTICLES COLLOID SOLUTION IN CHICK-PEAS GROWING TECHNOLOGY

Purpose of invention

Using colloid solution of molybdenum nanoparticles for seed treatment in the *Cicer arietinum* L. technology of chick-peas cultivation facilitates activation of “agronomically valuable” microflora, positive changes in the directivity of microbiological processes in the soil and increase of antioxidant protection of chick-peas plants

Performance-based specifications

The consumption rate of molybdenum nanoparticles colloidal solution is 1 l of a process solution per one ton of seed, which corresponds to a concentration of metal 8 mg/litre. Rizobophit consumption rate, according to the manufacturer's recommendations, is 200 g of the drug for 1.2 litres of water per hectare of sown seed, which corresponds to 1×10^6 concentration of bacteria per one seed

Key benefits of invention

Application of molybdenum nanosolution in combination with bacterial fertilizers has a positive effect on the transformation of organic matter, which increases in 3 times; mineralization processes are increasing under these conditions, the index of oligotrophy, which indicates an improvement in the trophic regime of the soil, is also increasing. Seed treatment with molybdenum nanoparticles solution provides the increase in field germination, bulb formation and yield

Intellectual property protection status

2 patents of Ukraine have been obtained

Market demand

The usage of a colloidal solution of molybdenum for pre-sowing seed treatment is unique not only for Ukraine, but also for the world-wide practice of cultivation of this crop

Standby status

The invention has been experimentally developed (field testing) and is ready for implementation



Colloid molybdenum solution

R&D Department

15, Heroiv Oborony str., Kyiv 03041, Ukraine
 email: org_section@nubip.edu.ua, <https://nubip.edu.ua/about>, Tel/fax: +38(044) 527-85-89



ROTARY OSCILLATING GRANULATOR FOR NITROGEN FERTILIZERS MELTING

Purpose of invention and sphere of application

Rotary oscillating granulator is used in the chemical industry and is designed to disperse the melt of nitrogen fertilizers into even drops in the prilling tower with their subsequent cooling and crystallization into solid granules in the process of free fall in the ascending mass of cold air

Essence of invention

Rotating oscillating granulator is a system of compactly arranged basic and supplementary equipment and pipelines. The usage of the monodispersion fundamentally improves the technology of fertilizer production.

Melt Granulator Performance: 10-100 t/h.

Granulated substance: ammonium nitrate, carbamide etc.

Rotational speed of the basket: 35-150 rpm.

Diameter of torch for prilling: 4-15 m



Key benefits of invention

The granulator has the following benefits comparing with other types of granulators:

- high operating reliability;
- producing of even granules with the possibility of adjusting their average size;
- reduction of the product adhesion to the towers;
- reduction of dust formation;
- increase of agrotechnical value of fertilizers

Intellectual property protection status

More than 30 patents of Ukraine on the invention and utility model have been obtained

Market demand

The modern rotating oscillating granulators of ammonium nitrate and carbamide are used at nitrogen fertilizer plants in Bulgaria, Estonia, Qatar, Cuba, Poland, the Republic of Belarus, Tajikistan, Uzbekistan, Ukraine etc.

Standby status

The invention is implemented at industrial plants

R&D Department, Centre of Scientific, Technical and Economic information

2, Rymkoho-Korsakova str., Sumy 40007, Ukraine

email: dkurbatov@sumdu.edu.ua, info@cinti.sumdu.edu.ua, Tel/fax: +38(0542) 68-78-69, +38(0542) 33-41-08



VORTEX GRANULATOR FOR POROUS AMMONIUM NITRATE PRODUCTION

Purpose of invention and sphere of application

The vortex granulator is used predominantly in the chemical industry and can be used to granulate various substances from solutions and melts

Intellectual property protection status

10 patents of Ukraine for the invention and utility model have been obtained

Essence of invention

The vortex granulator allows producing granular products without using prilling towers. The granulator functioning is based on the method of melts, solutions and suspensions granulation, which is based on the improvement of the granules flow dynamics. The vortex granulator produces up to 10 t/h of the final product. The final product possesses a degree of monodispersity of up to 98%, humidity level of up to 0.2% and the retention capacity of diesel fuel distillation of 7-8% and granule strength of 300–350 g/granule

Market demand

The invention can be used both as a mobile (at mining sites) or stationary one (at existing plants for the mineral fertilizers production) to produce granules of porous ammonium nitrate

Standby status

An exploratory-industrial prototype for research and production has been made

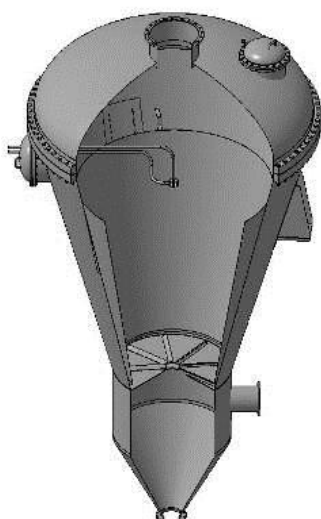

Oscillator and generator

R&D Department, Centre of Scientific, Technical and Economic information

2, Rymkoho-Korsakova str., Sumy 40007, Ukraine

email: dkurbatov@sumdu.edu.ua, info@cnti.sumdu.edu.ua, Tel/fax: +38(0542) 68-78-69, +38(0542) 33-41-08



BIOTECHNOLOGY OF METHANE AND FERTILIZERS PRODUCTION FROM HYDROBIONTS

Purpose of invention and sphere of application

The invention is intended for the biogas production from Hydrobionts organic mass, in particular from blue-green algae with the view of reducing the contamination of surface water, as well as for the usage of digestate as mineral-organic fertilizer

Essence of invention

An ecological bioenergy technology that provides cost-effective production of methane and fertilizers from blue-green algae harvested during “water bloom” of the Dnipro cascade water area has been invented. The technical result is obtaining 3.44 dm³ of biogas from 1.0 dm³ of concentrated substrate ($\rho \approx 1$) in 37 days in the mesophilic (30 °C) anaerobic conditions and obtaining 4.38 dm³ of gas of cavitated substrate in 42 days. Its quantitative and qualitative composition has determined as the following: CH₄ + H₂ (71,3%), CO₂ (20.4%), N₂ (6.5%) and other gases (1.9%) and combustion value: Q = 5.2 MJ/m³. The chemical composition and the dilution rate of the bio-fertilizer have been determined for 12 cultivated plants, that can increase the yield by 7.5 to 12%

Intellectual property protection status

5 patents of Ukraine have been obtained

Key benefits of invention

The invention differs in the type of the substrate used and in the quantitative composition of biogas. An increase in methane concentration is achieved due to the almost complete disappearance of hydrogen sulfide, which is a part of the biogas composition obtained from other substrates, and causes corrosion of metal structures. The removal of cyanobacteria from the body of water minimizes the environmental threat, caused by the consequences of water bloom, and improves the quality of drinking water in the region

Market demand

The main customers of the invention are public utility providers, farms, agricultural and forestry enterprises etc.

Standby status

Design documentation for the production of component parts of a fixed complex has been elaborated. The complex consists of the evaporation row and anaerobic chamber, which provides a production cycle, controlled by the original software. Biotesting of mineralorganic fertilizer and its approbation have been carried out in cameral and real-life conditions. Technical specifications for the product have been elaborated

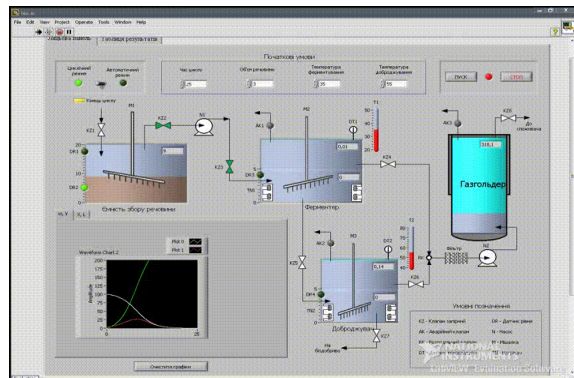
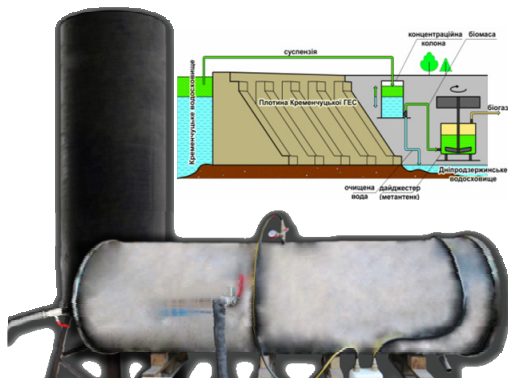

R&D Department

20, Pershotravneva str., Kremenchuk 39600, Ukraine
email: nich@kdu.edu.ua, [http:// www.kdu.edu.ua](http://www.kdu.edu.ua), Tel/fax: +38(05366) 3-62-17



MODERNIZATION OF CULTIVATOR *MAXIM*' PANTOGRAPH MECHANISM

Purpose of invention

Improving the reliability and durability of agricultural machinery and mechanisms are inextricably related to the improvement of the existing parts of swivel joints and the development of new wear-resistant ones. This applies primarily to friction units, cultivating machines, which operate under exceptionally rough conditions of high load and sliding velocity, the presence of abrasives and moisture. For instance, the trailer cultivator *Maxim*, intended for secondary tillage, is used in abnormally dusty conditions, therefore dust is accumulated on the bearing joints causing abrasive wear of a friction pair and significantly reducing the life of bronze bearings

Market demand

The bearing made of polymeric composite for the pantograph mechanism of the field cultivator is used at national enterprises, with open joint stock company "OZSM" *Agrotech*" as one of the main customers

Intellectual property protection status

The originality of the engineering solution is protected with six patents

Performance-based specifications

Carbon fiber reinforced plastic cups *AGT-90* are shown on the picture

Key benefits of invention

The invented slider bearings, made of carbon fiber reinforced plastic on the basis of polyamide *UPA 6-40*, were installed in the pantograph mechanism of the cultivator *Maxim* and ensured the increase in the durability of the friction joint in 3-4 times comparing with batch bronze parts bearing the trademark of *BrAZH 9-4*

Standby status

In 2014, there were produced 6.000 parts for the complete set of friction joints of the cultivator *Maxim*, which worked in the country's fields. The absence of faults or breakdowns of the parts produced of *UPA 6-40* for 3 years of operation indicates the applicability, relevance and viability of the invention

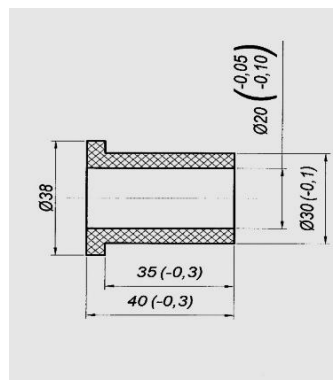

Carbo-fiber reinforced plastic cup

R&D Department, Department of R&D Information Support

2, Dniprobudivska str., Kamianske 51900, Ukraine
email: science@dstu.dp.ua, http:// www.dstu.dp.ua, Tel/fax: +38(0569) 50-63-37



COMPOSITE FOOD SUPPLEMENT FOR QUAILS

Purpose of invention and sphere of application

The food supplement of a combined effect with pre-, probiotic and immunomodulatory properties is intended for the increase of resistance, preservation and productivity of quails. It possesses an effective biosynthetic activity, a high ability of lactobacilli to adhere to epithelial cells, antibacterial and immunomodulatory effect

Essence of invention

Probiotic supplement *Lactokas* is constructed on the basis of the commercially valuable strain *Lactobacillus casei* IMB B-7280 which was obtained at Danylo Zabolotny Institute of Microbiology and Virology of National Academy of Science of Ukraine. The usage of pro- and prebiotics for quails increases the intensity of their growth, leads to the likely increase in live weight of quails by 8.1% in 56 days, saving by 7.3%, and allows realizing an additional profit and increasing of profitability by 5.7%. Probiotic supplement has been officially registered at the SCIVP of veterinary medical products and food additives. In order to increase the resistance, preservation and productivity of quails, it is recommended to include a complex of pro- and prebiotics into their diet *Lactokas* at a dose of 1×10^6 CFU per capita for the first 7-10 days. In 20 days the administration of the preparation should be repeated. 0.6% of the prebiotic complex is ought to be added to the combined feed

Market demand

Farms of different proprietary forms are the prospective users of the complex pre- and probiotic feed supplement

Standby status

A pilot sample of pre- and probiotic supplement has been made, scientific-industrial testing has been conducted and the positive influence of the probiotic complex on quails growth and keeping has been detected

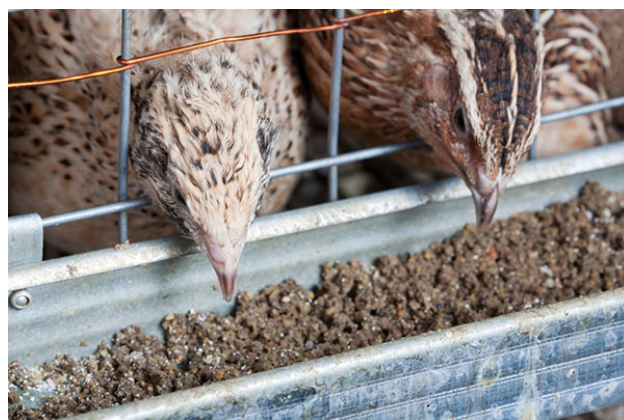

Intellectual property protection status

The patent on utility model has been obtained and technical requirements of Ukraine have been developed

Scientific and Innovative Activities Department

8/1, Soborna sq., Bila Tserkva 09117, Ukraine
email: taras.m.tsarenko@gmail.com, <http://www.btsau.kiev.ua>, Tel: +38(068) 353-63-69



METHOD OF REPRODUCTION AND CULTIVATION OF VALUABLE FISH SPECIES

Purpose of invention and sphere of application

The invention is intended for the reproduction and preservation of valuable and endangered fish species. It is applied to aquaculture and can be used in ichthyologic research and fish farming. Fish farms can conduct a clear genetic record of their breeding herd and breeding process, as well as protect their produce from falsifying

Essence of invention

The invention is based on the process of the obtaining all-female offspring of sturgeon fish, which includes the induction of the genetic development of embryos through the fertilization of egg cells with genetically deactivated sperm. This process is different because the induction of gynogenic development is applied to egg cells of the same species females via irradiation of sperm with ultraviolet rays and the initiation of the gynogenesis is carried out with the usage of temperature shock for fertilized roe

Intellectual property protection status

A patent of Ukraine for the utility model has been obtained

Market demand

The results of the invention can be implemented for a practical purpose at the fish industry enterprises and for research at scientific institutions

Standby status

The invention has been implemented on a fish farm of Ministry of Agrarian Policy and Food of Ukraine



R&D Department

15, Heroiv Oborony str., Kyiv 03041, Ukraine
email: org_section@nubip.edu.ua, <https://nubip.edu.ua/about>, Tel/fax: +38(044) 527-85-89



APPLICATION OF THE GAS MIXTURE FOR ANAESTHESIA OF STURGEON SPECIES IN CULTIVATING ENVIRONMENT

Purpose of invention and sphere of application

The invention is applied to the aquaculture industry and can be used in ichthyologic research and fish farming in the process of putting sturgeon fish in hypometabolic state for reducing stress, prevention of damage during sorting, transportation and also manipulations

Essence of invention

The method lies in saturation of the water, in which fish dwell, with a gas mixture of CO₂ and O₂ (in the ratio 1:1) under pressure of 102.6 kPa at a water temperature of 15-18 °C. The supply of the gas mixture is ceased when fish sinks to the bottom and stops moving. Fish can be kept for 1-2 hours in such a state and upon transferring individuals into clean water their physiological functions are restored within 5-8 minutes

Key benefits of invention

Among the benefits of the invention we should mention the absence of necessity to make a special unit as well as possibility of gas mixture saturation of water in aquariums of various volumes

Intellectual property protection status

A patent of Ukraine for the utility model has been obtained



Aquarium water saturation with a gas mixture to put fish in the hypometabolic state

Market demand

The results of the invention can be practically implemented at the fish industry enterprises and used for research at scientific institutions

Standby status

The invention has been implemented at a fish farm of Ministry of Agrarian Policy and Food of Ukraine

R&D Department

15, Heroiv Oborony str., Kyiv 03041, Ukraine
email: org_section@nubip.edu.ua, <https://nubip.edu.ua/about>, Tel/fax: +38(044) 527-85-89



NEW SHEEP BREED – PRYDNIPROVSK MUTTON SHEEP

Purpose of invention and sphere of application

The purpose of the invention was to create a new sheep breed as a basis for the development of specialized mutton sheep farming in Ukraine. The scope of application is agricultural enterprises of various forms of subordination, which activities are related to increasing the production of dietary environmentally friendly products – meat, wool and sheepskin

Essence of invention

By means of complex reproductive cross-breeding along with using the breeding material from Canada, France and Ukraine, a new breed of sheep has been bred and tested. The breed has been titled *Prydniprovsk mutton sheep*. This breed is characterized by high rate of meat productivity and reproduction ability; it also adapts well to the maintenance and breeding in various agro-ecological areas of Ukraine. The new breed has no analogues in terms of meat production in Ukraine. An average body weight of rams is between 115-125 kg, adult ewes – 62-70 kg, yearling ewes – 48-55 kg, lambs – 68-75 kg. Average daily gains in youngsters before weaning is 350-400 g. The young of the newly bred sheep has a mass of carcasses 22-24 kg with a slaughter yield of 49-52% at the age of 6-8 months. The breed shows signs of being polyestrous. The fertility of the ewes is within 142-145%. The usage of sheep sires of this breed enables to improve the aboriginal sheep breeds' meat quality by 18-24% and increase the reproductive capacity by 12-16%

Intellectual property protection status

The new sheep breed has been approved by the Decree of Ministry of Agrarian Policy and Food of Ukraine "On Approval of the Prydniprovsk Mutton Sheep Breed" No. 106 dated March 20, 2015. Two patents of Ukraine for the utility model have been obtained



Market demand

The invention is necessary for farms of different forms of proprietorship. Its implementation will enable the sheep industry to revive and expand the production of environmentally friendly products

Standby status

The innovation is ready for implementation

R&D Department

25, Serhiy Yefremov Str., Dnipro 49600, Ukraine
email: nauka_ddau@ua.fm, <https://www.dsau.dp.ua>, Tel: +38(056) 713-51-74



TECHNOLOGY OF AUSTRALIAN TROPICAL CRAYFISH REARING IN THE CONDITIONS OF THE SOUTH OF UKRAINE

Purpose of invention

The innovation is intended for expansion of the opportunities of domestic commercial aquaculture and establishing of conditions for the production of delicacies

Essence of invention

The technology involves the cultivation and reproduction of Australian tropical crayfish in simulated conditions of closed water supply systems during the autumn-winter period to a mass of 25-40 g with further rearing to the commodity weight (110 g) in the ponds in the south of Ukraine. It is necessary to ensure proper conditions for crayfish keeping in winter in order to achieve this purpose. They include the usage of closed water supply facilities or other systems which can provide this species with warm water for reproduction and bringing up younger age groups. Ponds in the south of Ukraine with their large natural food resources can be used for the extensive cultivation of Australian crayfish in monoculture. As a result of the proposed technology, tropical Australian crayfish have been raised in a one-year growing cycle with an average weight of 110 g (some specimens reached 187 g)

Key benefits of invention

The experience of Russian scientists, who have developed the technology of growing this type of crayfish in Astrakhan region and obtained quite successful result in the cultivation of commercial crayfish of 50-70 grams in a one-year growing cycle, proves the viability of this technology development for the cultivation of Australian crayfish in the south of Ukraine. The benefit of the invention is the ponds in the south of Ukraine which possess a high natural bio-production potential and therefore enable the breeding of Australian tropical crayfish using an extensive technology without feeding

Intellectual property protection status

A patent of Ukraine for the utility model has been obtained

Market demand

This new tropical crayfish delicacy will be in high demand on Ukrainian market

Standby status

The invention is ready for usage in commercial aquaculture



R&D Department

23, Sritenska str., Kherson 73006, Ukraine
email: shabaev_o@ksau.ks.ua, [http:// www.ksau.kherson.ua](http://www.ksau.kherson.ua), Tel/fax: +38(0552) 41-75-92



THERMOMECHANICAL DEVICE WITH THERMOSYPHONS

Purpose of invention and sphere of application

The invention is intended for grain, rapeseed, amaranth and coffee slurry drying and also for concentrating squash of fruit and vegetables – these are processes of heat treatment (heating, concentrating, drying) of dispersed and viscous products and materials

Key benefits of invention

The design of the heat transmission module in the form of an autonomous rotational thermosyphon possesses a low rate of heat resistance, ensures the organization of processes with minimum energy consumption and guarantees the safety of the food product by using different types of fuel and energy. The intensity of heat and mass transfer in the device is 2-20 times stronger than that of similar mechanisms. It is notable for its design reliability and ease of operation

Market demand

Processes of drying grain crops and producing vegetable and fruit purees are important for agro-industrial enterprises. Production of thick and dry extracts is important for both pharmaceutical and processing plants

Essence of invention

The carried out mechanical action on the “heating surface – product” area contributes to the destruction of the thermal and diffusion boundary layers. As a result, the vapour phase is easily released from the product, the surface of the rotary thermosyphon is being constantly cleaned and the heat transmission coefficients increase substantially. The degree of intensity increase grows with the product viscosity. The design feature of the device is the usage of an autonomous rotary two-phase thermosyphon, the condensation section of which performs mechanical functions in addition to heat transmission. There is mixing, transportation or crushing of the product among them. For this purpose, the thermosyphon condenser is of the shape that corresponds to the engineering aim of the device

Intellectual property protection status

A patent of Ukraine for the invention has been obtained

Standby status

An operating industrial prototype of the mechanism has been made



Department of Regulatory and Engineering Provisions and Metrology

112, Kanatna str., Odesa 65039, Ukraine

email: nauka@onaft.edu.ua, <http://udhtu.edu.ua>, Tel/fax: +38 (048) 712-41-30, 724-28-75



BLOCK GRAIN DRYER

Essence of invention

The furnace gases enter the gas pipeline (1) from the evaporators of thermosyphons (TS). TS condensation sections are located in the ball heater of the grain (2). The air is heated to the temperature of the drying agent which is fed to the drying section (3) in the air heater with the TS 4. 42% of the heating agent is not released into the environment from the block dryer, but is recycled thus reducing energy loss with the used heating agent. The energy is fed to the grain through the TS. This ensures environmental safety of drying, even energy supply to the grain and its efficient mixing. The efficiency of the block grain dryer increases up to 20–22% in comparison with the basic scheme.

Technical Specifications

- productivity during the process of wheat drying (from 20 to 14%) – 6 tons per hour;
- expenditures: fuel – 5.24 kg per ton; energy – 3.5–3.7 MJ per kg of moisture;
- thermal efficiency – 60%;
- heating agent – heated clean air.

The design of the ball heater of grain:

- Number of TS – 130, number of TS lines – 20;
- Dimensions of the section/gas pipeline, m: height – 1.2/1.2, width – 0.7/0.7, depth – 0.7/0.5.

The design of the heater with the thermosyphons:

- Number of TS – 208, number of TS lines – 8;
- Outer dimensions, m: height – 2; width – 1.4; depth – 0.4

Standby status

An operating industrial prototype of the mechanism has been made

Intellectual property protection status

2 patents have been obtained

Market demand

The production of wheat in Ukraine reaches up to 26.5 million tons causing the need for the grain dryers at the agro-industrial enterprises

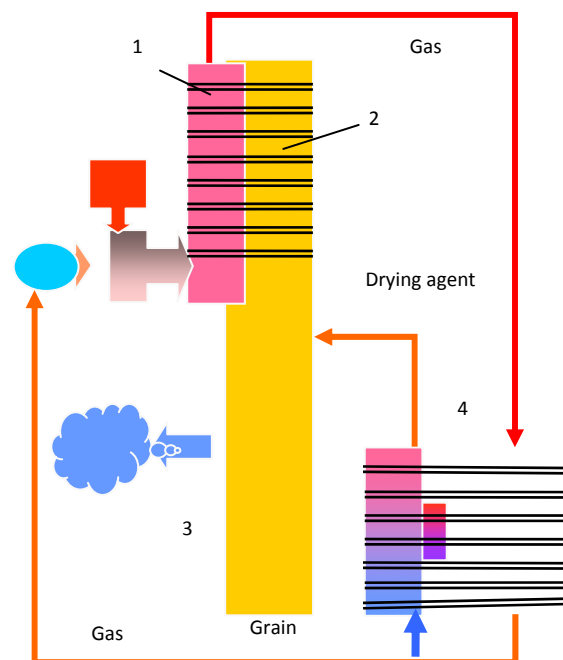



RECUPERATIVE GRAIN DRYER

Essence of invention

The technical idea of the device application is that the address energy delivery to the grain flow is carried out by a two-phase evaporative-condensation system. Evaporators are heated by furnace gases (or any other source of energy), and the capacitors transmit the energy to the grain flow. Air acts as a medium only and takes moisture from the grain. The absence of direct contact between the grain and the furnace gases guarantees the production of a safe product. Low air consumption minimizes energy loss with the used heating agent, i.e. ensures the high energy efficiency of the dryer. The fuel energy is transformed into the energy of the combustion products, which are transformed into the energy of water vapour in the evaporator. The latter is fed into the condenser through a steam line, which is made in the form of a bundle of tubes. The grain moves along the tubes in which the steam condenses and the condensate through the pipeline returns to the evaporator. The design of the condenser facilitates the efficient mixing of the grain flow. The energy of the evaporation from the grain is used to heat the grain before drying. The efficiency of the dryer reaches 80-85%

Key benefits of invention

The heating of the grain flow before drying occurs in conditions of partial condensation of water vapour from the heating agent in the pipes. This enables the return of almost 75% of the energy used to remove moisture from the grain back to the grain flow (for its heating). In addition, the intensity of the transfer of thermal energy from the heating agent to the cold grain is significantly increasing

Intellectual property protection status

1 patent has been obtained

Market demand

The production of wheat in Ukraine reaches up to 26.5 million tons causing the need for the grain dryers at the agro-industrial enterprises

Standby status

An operating industrial prototype of the plant has been made

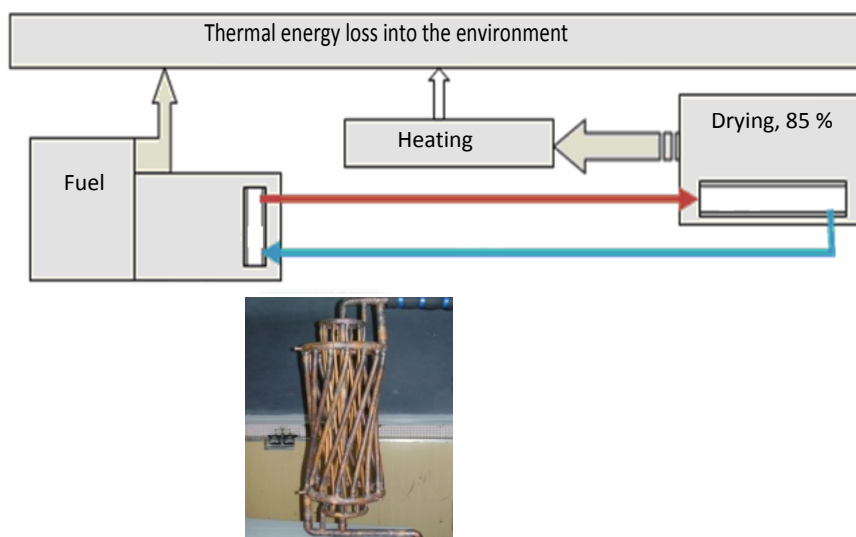



HOUSEHOLD APPLIANCE FOR BIOGAS PRODUCTION

Purpose of invention

Biogas is a type of biofuel, which is formed during natural decomposition of substances of organic origin as a result of anaerobic microbiological process. Biogas usage is one of the ways to partially replace natural gas. The technology of biogas production is based on organic waste disposal in both private households and agro-industrial enterprises. The engineered biogas appliances are intended for organic waste disposal via anaerobic fermentation, and this technology solves the problem of using biomass waste as biofuel

Market demand

The appliance can be used in agriculture and food industry, as well as in private households

Standby status

The energy-efficient design of a household bioreactor has been engineered and implemented. The efficiency of the usage of the reservoir rational form has been proved

Essence of invention

The bioreactor is of a cylindrical shape with cut cones at the bottom and at the top. The volume of the reservoir is 1 m³. It is made of 7 mm thick metal and is completely leakproof. There is a U-shaped tube heat exchange unit inside the bioreactor. The required internal temperature setting is from 35 to 55 °C. The expected biogas output is 2.5 m³ per day

Intellectual property protection status

2 patents of Ukraine for the utility model have been obtained





COMPLEX DISINFECTANT PREPARATION *HEOCID* FOR SANITATION OF LIVESTOCK ENTERPRISES PREMISES

Purpose of invention and sphere of application

The innovation is intended for implementation of a complex sanitation of premises for cattle, pigs, poultry in processing enterprises, markets, as well as in residential premises

Essence of invention

The developed technology for obtaining a complex, safe disinfectant *Heocid* which possesses antibacterial, disinsection properties is realized through the synergism of the action of the quaternary ammonium compound, the polymethyleneguanidine hydrochloride and the synthetic pyrethroid. The anti-germ, anti-fungal, insecticidal effect of the *Heocid* has been established *in vitro* and *in vivo*. The safe concentration of the *Heocid* has been determined according to the culture activity rate of *Tetrahymena pyriformis* infusoria. Also the effective modes of using the *Heocid* for disinfection and disinsection of livestock enterprises premises have been confirmed, which provides the possibility to use it as a complex action preparation in 0.5-5.0% concentrations with high quality and safety. The conditions of non-specific resistance of animals under the influence of *Heocid* have also been studied. The effective use rate of a disinfectant solution for safe influence on the animals' immunity status is 0.5%



Market demand

Innovative technology provides the possibility to improve the system of veterinary and sanitary measures, reveal new criteria for the production and usage of the preparation in the presence of animals. The complex disinfectant *Heocid* is used at many livestock enterprises, both in Ukraine and abroad

Intellectual property protection status

The patent on utility model has been obtained and technical requirements of Ukraine have been developed

Standby status

The invention is ready for usage

Scientific and Innovative Activities Department

8/1, Soborna Sq., Bila Tserkva 09117, Ukraine
email: taras.m.tsarenko@gmail.com, <http://www.btsau.kiev.ua>, Tel: +38(068) 353-63-69



PORTABLE DEVICE FOR NON-METAL SURFACES SANITATION

Purpose of invention and sphere of application

Fields of application of the invention are disinfection and preventive treatment of non-metal (polymers, concrete, bricks, etc.) surfaces with the formed biological film, including those infected with pathogenic microorganisms. The device is designed for sanitary treatment of poultry farms premises, cowsheds, pig farms, etc., in order to prevent the spreading of infectious animal diseases. Also, the device has the potential for disinfection of polymeric containers, sanitation of swimming pool walls, sanitary surface treatment in recreation facilities, etc.

Essence of invention

The disinfectant agent generated by the proposed device eliminates all the known types of microorganisms, including polyresistant viruses, tubercule bacilli, staphylococcus, etc., most of the strains of fungi and algae. The solution for disinfection is non-toxic; the only product of evaporation is water. When applied to porous surfaces, the solution produces a prolonged bacteriostatic effect, which, for instance, is able to preserve the microbiological quality of water in the processed polymeric capacity up to 10 times longer compared to storage in the untreated container. The device is capable of generating up to 30.000 litres of disinfectant solution prior to scheduled replacement of consumable materials. The processing cost of 100 m² is about \$0.20. The capacity of the device is less than 1 W, which makes the invention portable and energy efficient

Intellectual property protection status

2 applications for the patent of Ukraine on the invention and the utility model have been submitted

Market demand

The invention may be of interest to poultry farms, livestock enterprises etc.

Standby status

A prototype of the invention has been produced, microbiological tests which confirmed the high efficiency of the device have been conducted, a wiring diagram and schemes of assembly and installation have also been designed



R&D Department

2, Kyrpychova str., Kharkiv, 61002, Ukraine

e-mail: nti@kpi.kharkov.ua, <http://www.kpi.kharkov.ua>, Tel/Fax: +38(057) 707-62-13



APPLICATION OF BIOLOGICALLY ACTIVE SUBSTANCES OF HERBAL ORIGIN FOR PREVENTION OF DISEASES, INCREASING THE PRODUCTIVITY AND IMMUNITY OF ANIMALS

Purpose of invention

The purpose of the new phytopreparations based on biologically active substances is the prevention of diseases of the digestive system, increasing the productivity and immunity of small stock and poultry: newborn calves, sheep, goats, chickens, dogs, etc.

Essence of invention

Finally the usage of phytopreparations *Phytohol*, *Phytopank* and *Hastrocid* for the treatment and prevention of gastrointestinal diseases of young animals of productive and small stock and poultry has been substantiated theoretically and experimentally. *Phytohol* has biologically active compounds of six medicinal plants in its composition. They include biologically active substances that form a film that protects sensitive nerve endings of tissues from further irritation when applied to the mucous membrane or wound. This process is accompanied by pain reduction, local narrowing of blood vessels and decrease of secretory processes. *Phytopank* is a composition of alcoholic tinctures for correction of the immune system and has seven medicinal plants in its composition. *Hastrocid* is a composition of alcoholic tinctures of ten medicinal plants. The main components of the essential oil are lanalol, linalil acetate and others, which possess anti-germ and anti-allergic properties, activate the work of the stomach and intestines

Intellectual property protection status

6 patents of Ukraine have been obtained

Key benefits of invention

The benefit of the new drug is its ability to positively affect metabolic processes, natural resistance, preservation, growth and productivity. The criteria of preventive effectiveness of the new drug usage is a decrease of the disease incidence up to 40–50%, growth of the average daily increase to 10–15% and preservation of young animals by 15–20%. Economic efficiency is 3.68–15.0 UAH per 1 UAH of expenses

Market demand

The invented phytopreparations possess an advantage over synthetic and chemical remedies and can be in high demand in livestock breeding for treatment and prevention of gastrointestinal diseases in animals

Standby status

Samples of the phytopreparations have been produced, the principles and doses of the application have been determined and the expected characteristics in the manufacturing environment have been scientifically substantiated and experimentally confirmed



R&D Department

25, Serhiia Yefremova str., Dnipro 49600, Ukraine
email: nauka_ddau@ua.fm, <https://www.dsau.dp.ua>, Tel: +38(056) 713-51-74



PREPARATIONS FOR TREATMENT AND PREVENTION AND FOOD SUPPLEMENTS BASED ON BIOLOGICALLY ACTIVE SUBSTANCES OF HUMIC ORIGIN

Purpose of invention and sphere of application

Preparations are used to correct the metabolism, form high-quality bioproducts of livestock breeding and accelerate animals' recovery. Such products are intended for maintenance of organic production of livestock products by agricultural enterprises, as well as for increasing the range of domestic preparations for serving pets in private clinics of veterinary medicine

Essence of invention

Humic substances (a group of macromolecular compounds formed in peat and sapropel in the process of decay of vegetation and animal tissues) are active ingredients in the composition of therapeutic and preventive drugs and feed supplements. The analysis of the physicochemical composition of various peat deposits, their biological activity and toxicity has been conducted and various methods of obtaining finished products have been compared. Samples containing the most biologically active substances have been selected as raw material for medicine and feed supplements manufacturing using the optimal technology. The invented preparation offers antioxidant, anti-inflammatory, membranotropic and hepatoprotective properties, which can increase the activity of metabolic process. In case of topical application the preparation accelerates cell renewal, reparative and regenerative processes in damaged tissues, improves wounds and ulcers healing



Market demand

Such products can be used at livestock enterprises and on farms, in state hospitals and private clinics of veterinary medicine

Standby status

Efficiency of feed supplements and dosage forms for external use on animals has been researched. Technical specifications for *Humilid*, *Eco Impulse Animal* and *Humipharm* have been registered

Intellectual property protection status

4 patents of Ukraine have been obtained

R&D Department

25, Serhiia Yefremova str., Dnipro 49600, Ukraine
email: nauka_ddau@ua.fm, <https://www.dsau.dp.ua>, Tel: +38(056) 713-51-74



METHOD OF INTRAVITAL DIAGNOSTICS OF BOVINE LEUCOSIS WITH TWO-STAGE POLYMERASE CHAIN REACTION

Purpose of invention and sphere of application

Innovative product belongs to the field of veterinary medicine and can be used to diagnose bovine leucosis in blood samples or other biological fluids

Essence of invention

The method of intravital diagnosis of bovine leucosis with two-stage polymerase chain reaction (PCR) includes: sampling, DNA extraction from the samples, conducting the first stage of the PCR, conducting the second stage of PCR in real-time mode, visualization and analysis of the results obtained

Key benefits of invention

The second stage of the PCR is conducted in real-time mode, which enables a multiplex analysis to be performed (carrying out the detection of two targets simultaneously in one test tube). For the second stage of PCR, the developed primers and fluorescence probes are used for two targets: the ENV of the leucosis preventive gene and the PRP gene, which is specific to cattle (endogenous control). Endogenous control serves to control the quality and quantity of DNA extracted from blood lymphocytes, resulting in the prevention of pseudo-negative results. In addition, the usage of real-time PCR does not require to conduct the separation of amplification products in agarose gel (the visualization of the results takes place on the computer monitor), which prevents the contamination of the working environment with products of amplification and makes the method of diagnosis of bovine leucosis with two-stage PCR method safer

Intellectual property protection status

The patent of Ukraine on the utility model has been obtained

Market demand

The results of the invention can be used by veterinary diagnostic laboratories

Standby status

The invention was implemented by the Ukrainian Laboratory of Quality and Safety of Agricultural Products

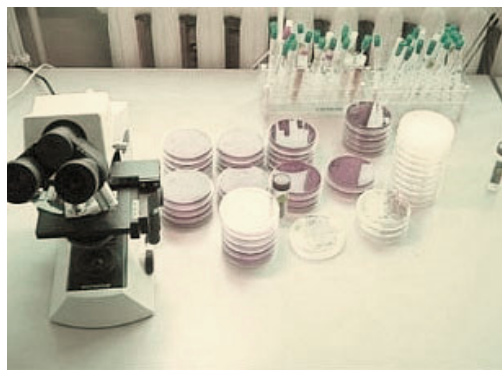

R&D Department

15, Heroiv Oborony str., Kyiv 03041, Ukraine
email: org_section@nubip.edu.ua, <https://nubip.edu.ua/about>, Tel /fax: +38(044) 527-85-89



METHOD OF INTRAVITAL BLOOD SAMPLING OF POULTRY

Purpose of invention and sphere of application

The method is intended for obtaining qualitative serum, plasma and whole blood for biochemical and morphological research. Among the prospective users of the method of intravital blood sampling of poultry there are departments of research institutes and industrial enterprises, central, region and district laboratories of State Service of Ukraine for food safety and consumer protection

Essence of invention

The most important feature of the invention is the ability to use a single puncture of the axillary vein, which allows from 6.0 to 12.0 cc of blood to be taken at a time. Thus, only one intravascular needle insertion is performed. This enables the usage of the material received for the early diagnosis of non-infectious and infectious poultry diseases and control of the effectiveness of veterinary health-improving and preventive measures, in contrast to the existing methods of blood sampling of poultry. Such technique has been developed in Ukraine for the first time

Key benefits of invention

The method of intravital blood sampling practically carries out the reception of high-quality investigated material (serum and plasma of blood) for research, which enables the development of standardized norms of content of metabolism indicators, physiological state and poultry productivity



Intellectual property protection status

Standard of Ukrainian Companies (SUC) by Ministry of Agrarian Policy and Food has been obtained

Market demand

The invented technique can be used by both research institutions and veterinary services of poultry enterprises regardless of the property category

Standby status

The method of intravital blood sampling of poultry has been theoretically substantiated and experimentally verified

Scientific and Innovative Activities Department

8/1, Soborna Sq., Bila Tserkva 09117, Ukraine

email: taras.m.tsarenko@gmail.com, <http://www.btsau.kiev.ua>, Tel: +38(068) 353-63-69



METHOD OF SIMULTANEOUS DETECTION OF BOTH ENTEROBACTERIA AND NEUTROPHILIC FUNGI IN BEE POLLEN

Purpose of invention and sphere of application

The method is intended for optimizing the process of microbiological research of bee pollen for simultaneous detection of enterobacteria and certain genera of neutrophilic fungi in samples. Prospective users of the item are diagnostic laboratories which assess the microbiological safety of a food supplement – bee pollen

Essence of invention

An inoculation is incubated at 35 ± 2 °C for 2 days. After that the enterobacteria species are identified. Preliminary registration of mould and description of their isolates in Petri dishes are carried out in 3-4 days. Subsequently, the inoculation is incubated at 25 °C for another 10-12 days or at 35 °C for 5-7 days and, in the end, the final calculation and generic identification of the colonies of fungi are carried out



Key benefits of invention

The suggested method allows the detection of conditionally pathogenic gram-negative enterobacteria of 5 genera for 1–2 days, facilitation of the results accounting and identification of fungi due to the formation of medium-diameter colonies with clear cultural features, retention of nutritious environments during the study of bee pollen owing to the joint detection of germs of various morphological groups

Intellectual property protection status

The patent of Ukraine for the utility model has been obtained

Market demand

The introduced method can be used in veterinary medicine laboratories in Ukraine

Standby status

The technique of the suggested method of microbiological research has been developed, the benefits of the item under development are confirmed

R&D Department

15, Heroiv Oborony str., Kyiv 03041, Ukraine

email: org_section@nubip.edu.ua, <https://nubip.edu.ua/about>, telephone/fax: +38(044) 527-85-89



VETERINARY MEDICINE “MEMBRANOSTABIL”

Purpose of invention and sphere of application

The preparation is intended for health promotion of newborn calves and can be used in veterinary medicine

Essence of invention

The preparation has the form of macrocapsule made from phospholipid bilayer, filled with water-soluble forms of vitamins A and E. A technical solution of a new veterinary preparation is a membrane-stabilizing action, which is based on phospholipid capability to keep the formula of enterocyte plasmalemma stable. In its turn, it determines the activity of immunoreceptor proteins of intestinal canal enterocyte plasmalemma to colostrum immunoglobulin, facilitates the formation of a sufficient level of a colostrum immunity, which protects the animal organism from causative agents both of contagious and non-contagious pathology and, what is more, prevents indigestion in newborn calves



Intellectual property protection status

The patent of Ukraine for the utility model has been obtained

Market demand

The preparation may be used for treatment and prevention of immune deficiency and increase the level of colostrum immunity in all breeding farms, which specialize in young-stock breeding of cattle

Standby status

Manufacturing technology of treatment-and-prophylactic preparation “Membranostabil” has been created and developed, its physical and chemical, pharmacological and pharmaceutical characteristics have been examined

R&D Department

15, Heroiv Oborony str., Kyiv, Ukraine 03041

e-mail: org_section@nubip.edu.ua, <https://nubip.edu.ua/about>, Tel./fax: +38(044) 527-85-89



APPLICATION OF ELECTRO-ADHESIVE TISSUE FUSION IN VETERINARY MEDICINE

Purpose of invention and sphere of application

The innovation is designed to implement a device for radiofrequency electric welding of living bio-tissues, "Paton VET" into veterinary practice. Moreover, it can be used for creating new instruments for carrying out various surgeries, taking into account peculiarities of the course of diseases in different animals

Performance-based specifications

The work can be carried out in cutting, coagulation and auto-welding modes. The invention has a wide range of work and working parameters algorithm selection, which depends on surgery kinds and characteristics adaptation, changes and additional program launching according to user's wish is possible. The development has two working frequencies – 66 and 440 kHz, power control (max. 300 W). Simultaneous connection of two instruments according to surgeon's wish is possible



Key benefits of invention

Electric welding is promising, as creation of the specialized instrument shortens the time of formation and improves the quality of post-surgical suture. The usage of welding in laparoscopic operations with the help of specialized instrument is the most effective

Intellectual property protection status

The patent application of Ukraine is being prepared

Market demand

The invention can be used in vet surgery in clinics of Ukraine

Standby status

Already existing equipment is upgraded in order to improve its reliability, ergonomics, workability and supporting, adaptation to surgeon requirements. For new surgical techniques and meeting user needs a new program product is being developed. New models of universal equipment are being developed and specialized equipment for separate surgery fields (ophthalmology, neurosurgery etc.) is being created

R&D Department

15, Heroiv Oborony str., Kyiv, Ukraine 03041

e-mail: org_section@nubip.edu.ua, <https://nubip.edu.ua/about>, Tel./fax: +38(044) 527-85-89



OZONE THERAPY IN VETERINARY SURGERY PRACTICE

Purpose of invention and sphere of application

The proposed ozone therapy is designed for improving efficiency of complex therapeutic measures for wounds healing, which are complicated by purulent infection. Potential users of this invention are veterinary medicine clinics of different types of incorporation, which provide treatment of small domestic animals

Essence of invention

Wounds cavern sanitation is realized with the help of ozonized physiological salt solution of sodium chloride with ozone concentration of 7 mg/L at the rate of 200-250 ml once a day during 2-3 days. Ozonation is carried out at ozone flow velocity 0, 5 l/m during 10 m

Key benefits of invention

Ozone therapy is unique in veterinary medicine. This method allows to shorten the duration of surgical service, improve reparative regeneration, reduce the chance of recurrences

Intellectual property protection status

2 patents of Ukraine on utility model have been obtained.

Market demand

Lack of efficacy in infected wounds treatment of animals, especially dogs, demands introduction of new treatment methods, which allow to shorten the duration of reparative regeneration

Standby status

The clinical testing of post-operation ozone therapy has been performed including the use of ozonized saline solution for dogs. It has proved the acceleration of regenerative processes and reducing the likelihood of recurrence



Ozonator YM-80 and its usage in dog wounds treatment

Scientific and Innovative Activities Department

8/1, Soborna sq., Bila Tserkva, Ukraine, 09117

e-mail: taras.m.tsarenko@gmail.com, <http://www.btsau.kiev.ua>, tel.: +38(068)353-63-69



METHOD OF OBTAINING CHICKEN EGG YOLK ANTIBODIES TO AFLATOXIN B1

Purpose of invention and sphere of application

The invention is related to the field of veterinary and humane medicine, biotechnology, microbiology, and it can be used to detect micotoxins in food products and feed

Intellectual property protection status

A patent of Ukraine on utility model has been obtained

Market demand

The invention results may be implemented for practical purposes during research in scientific institutions

Standby status

The invention has been implemented at research and development laboratories

Essence of invention

The method is implemented in the following way: aflatoxin B1, prepared by conjugation with carrier protein and emulsion creation through adjuvant adding, is inserted to laying hens subcutaneously in the lower part of the neck and chest muscles, around 0,5-1 ml three times on 1, 10 and 20 days of the immunization cycle with further generating of diagnostic immunoglobulins from the yolk. In 30 days after the first immunization, the trial breeding of hen's eggs is carried out in order to evaluate a specific antibody titre. In case of 1:640 and higher specific antibody titre attainment, which can be analyzed by enzyme-linked immunosorbent assay (ELISA), an everyday selection of hen's eggs is carried out. Egg collection is carried out until the specific antibody titre in the ELISA is 1:640

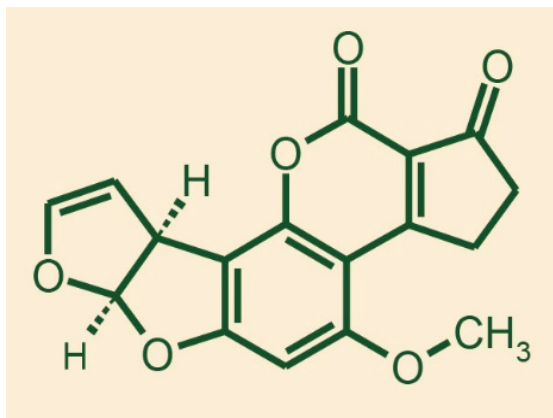

R&D Department

15, Heroiv Oborony str., Kyiv, Ukraine 03041

e-mail: org_section@nubip.edu.ua, <https://nubip.edu.ua/about>, Tel./fax: +38(044) 527-85-89



METHOD OF CANNED MEAT TOXICITY EVALUATION

Purpose of invention and sphere of application

The invention is related to the field of veterinary medicine, especially to the veterinary sanitation, and can be used for canned meat toxicity testing

Intellectual property protection status

A patent of Ukraine on utility model has been obtained

Market demand

It can be used as express-method during canned meat toxicity analysis

Standby status

The developed method has passed experimental tests and is ready for large-scale exploitation

Essence of invention

The proposed method enables us to carry out testing of the canned meat toxicity by accurate calculation of dead and alive infusoria *Tetrahymena pyriformis* through its colouring and assess the percentage of products toxicity for food poisoning prophylaxis. To do this task we should put 1 cm³ of *Tetrahymena pyriformis* cultures in sterile conditions, with a number of cells determined in Goryaev's cell in 1 cm³, then transfer them under sterile conditions to 0,1 cm³ of the test sample in a pure test tube, then add 0,2 cm³ of 5% aqueous solution of eosin, stir and keep for 5 seconds, then add 0,3 cm³ of 10% aqueous solution of nigrazin, mix and keep for 6 seconds, then prepare a thin smear, and by counting the dead infusions that are dyed in pink, we can determine the toxicity

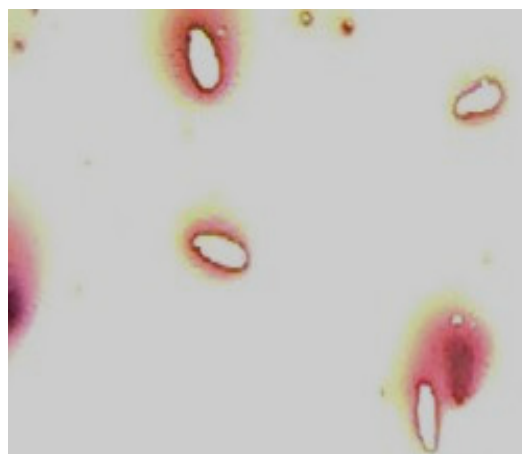
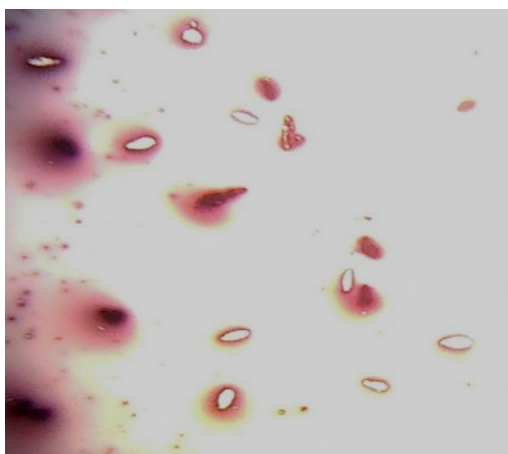

Tetrahymena pyriformis, dyed with eosine-nigrosine

R&D Department

15, Heroiv Oborony str., Kyiv, Ukraine 03041

e-mail:org_section@nubip.edu.ua, <https://nubip.edu.ua/about>, Tel./fax: +38(044) 527-85-89



DETECTION OF BACILLARY CAUSATIVE AGENTS OF POISONING AND FOOD SPOILAGE

Purpose of invention and sphere of application

The invention is designed to speed up the identification of bacillary causative agents of food poisoning and food contamination. The proposed methodology can be used in foodstuff industry, biology, molecular biology, medicine, microbiology at the laboratories, which have appropriate equipment and competent personnel

Essence of invention

The proposed invention is based on the polymerase chain reaction (PCR). The molecular genetic diagnostics with appropriate conditions and pairs of primers gives the opportunity to speed up the process in comparison with well-known methods of phenotypic diagnostics of regimented bacilli by 2-3 times due to specific genes detection with simultaneous identification of entero- and ematic toxicity. Due to regimented microorganisms identification, especially *B. cereus*, and also bacilli, which cause food contamination (*P. polymyxa*, *P. macerans*), comprehensive assessment of some bacillar contaminants with the help of devised schemes, which can be realized for different product groups is possible

Key benefits of invention

The proposed approach and methodology give the opportunity of exact and quick identification of potentially dangerous objects with contaminants of microbiologic origin, which is important for food and raw food materials safety identification and environmental safety, and also for food systems quality monitoring

Intellectual property protection status

2 patent applications of Ukraine on the invention and 4 patent applications on a utility model are under preparation. 1 patent of Ukraine on utility model has been obtained

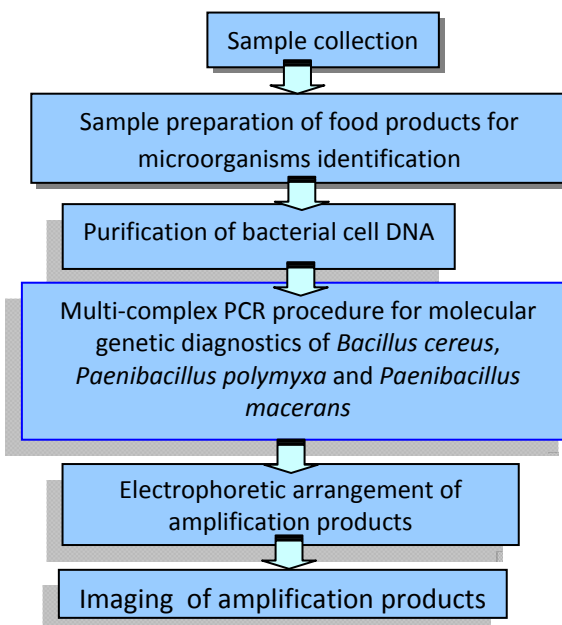

Scheme of accelerated method of toxicogenic *Bacillus cereus*, *Paenibacillus polymyxa* and *Paenibacillus macerans* identification in plant products and its conversion products

Market demand

The invention can be used in modern food industries with laboratories, regional veterinary inspectorates for safety and quality monitoring, aimed on retaining and health improvement of country's population

Standby status

Sanitary and hygienic procedure schemes with accurate identification of regimented bacillary microorganisms, using molecular genetic diagnostics of different product groups have been devised

Department of Regulatory and Engineering Provisions and Metrology

112, Kanatna str., Odesa, Ukraine 65039

e-mail: nauka@onaft.edu.ua, www.udhtu.edu.ua, Tel./fax: +38(048) 724-28-75



PRODUCTION TECHNOLOGIES OF BAKERY PRODUCTS WITH IMPROVED QUALITY AND SAFETY DURING PRODUCTION AND STORAGE

Purpose of invention and sphere of application

The invention deals with new wheat bakery products manufacture, which technology provides the usage of phyto- raw materials with essential technological properties and valuable physiological effect. Phyto essence application is an alternative to conditioners of synthetic origin

Essence of invention

By means of using the hawthorn, briar and hop phyto essences we can achieve: dough physical properties regulation, bakery products quality stabilization provided that there is a flour strength oscillation, yield enhancement and the increase of its barrier action. Also there might be the improvement of high-speed technologies, provision of high-grade product, which is more stable to hardening and bacteriological damage due to duration reduction of technological cycle by 25-40% as a result of flour systems modification by nutrients in short supply as components of phyto essences. Formula and parameters of technical process for operating conditions with speed up and conventional technologies with account of possible deviation of raw material quality and performance features of domestic bakery plants and bakeries have been devised

Intellectual property protection status

6 patents on new bakery products and its manufacturing technology have been obtained

Market demand

Market outlet of products is wide, because the main amount of buyers (83,1% according to statistics) prefers bread without additives of synthetic origin with significant bread aroma and flavor

Key benefits of invention

Investment prospects of proposed technologies lie in effective solution of field's problem, replaceability of conditioners by phyto raw material. In its turn, this gives the products of mass consumption a physiological effect of modernity need. The economic effect is achieved due to bread yield increase, manufacture duration reduction, reduction of product returns from outlet chain as a result of products quality improvement, prolonged terms of its freshness retaining, better resistance to bacteriological damage, absence of potentially destructive to human health synthetic additives in mixture due to the improvement of its protective and restorative properties

Standby status

Technologies have been industrially tested and are ready for implementation



Bread with hop extract



Bread with hawthorn extract

Department of Regulatory and Engineering Provisions and Metrology

112, Kanatna str., Odesa, Ukraine 65039

e-mail: nauka@onaft.edu.ua, www.udhtu.edu.ua, Tel./fax: +38(048) 724-28-75



“POSTPONED BAKING” TECHNOLOGY FOR BAKERY PRODUCTS OF SPECIAL PURPOSE

Purpose of invention and sphere of application

Frozen premade bakery products have a wide range of realization - home-baked products, bistros, cafes, bakeries, shops, bakeries at supermarkets, restaurants etc. The devised technology gives a wide range of bakery products without using extra staff and equipment



Essence of invention

Progressive methods of quality improvement and provision of health focus products, which are baked from frozen or partially baked premade products due to selection and combining of natural formula elements with essential technological and physiological properties (briar extract, lecithin, treacle, powder, laminaria, wheat bran, various kinds of flour) have been devised.

The examination of physical-chemical and structure-mechanical bread characteristics with proposed elements proves the solubility of key problems of “Postponed baking technologies” without usage of synthetic stabilizers of quality, most of which have a negative influence on human organism because of inorganic origin. Used raw material, rich in macro-, micro-elements, vitamins, dietary fibres, helps to obtain high quality products



Frozen premade bakery products

Intellectual property protection status

9 patents of Ukraine have been obtained

Market demand

The possibility of long-storage of semi-made products, fresh-baked bakery products realization at any time of a day and proximity to a customer in a wide range of products is a priority

Key benefits of invention

The devised technology allows better planning of manufacture, trade stocks provision. The economic effect is achieved by means of lack of defective products, undistributed stocks and less weight loss during long storage

Standby status

Approbation has been carried out under production conditions. The drafts of regulatory documents for new kinds of frozen semi-finished bakery products have been developed

Department of Regulatory and Engineering Provisions and Metrology

112, Kanatna str., Odesa, Ukraine 65039

e-mail: nauka@onaft.edu.ua, www.udhtu.edu.ua, Tel./fax: +38(048) 724-28-75



PRODUCTION TECHNOLOGY OF SUGAR CONFECTIONERY WITH SYNBIOTICS

Purpose of invention

The invention is designed to create new products (marmalade, cream confectionery, marshmallow with synbiotics), which may be eaten by people with abnormality of the intestinal microbiocenosis, that is good for product-line expansion of healthy confectionery products

Essence of invention

On the basis of technological and physiological pro- and prebiotics practical measures have been developed. That gave the opportunity to get marmalade, cream confectionery, marshmallow with the use of synbiotic complex. On the one hand, it will supplement people rations with physiologically essential micronutrients, improve application characteristics and absorbency of confectionery, and on the other hand to attract consumer's interest.

Manufacturing process of cream confectionery, marmalade and marshmallow with synbiotic complex, which consists of probiotics – non-pathogenic bifidus bacteria *Bifidobacterium bifidum*, and prebiotics – lactulose, have been developed. Addition of created products to a food ration allows to control and design certain physiological functions, connected with intestinal canal microflora normalization, and will boost human immunity

Key benefits of invention

The devised technologies help to get sugar confectionery products with anti dysbiosis properties and have a healthy effect on dysbiosis treatment. The usage of synbiotic additive helps to get such technological effects: structural-mechanical properties improvement of semi-finished products, organoleptic properties improvement of ready products, the reduction of sugar in the formula by 10%, the slowdown in the process of products hardening due to moistness loss reduction

Intellectual property protection status

3 patents of Ukraine on devised confectionery products have been obtained

Market demand

The market outlet of proposed products is rather wide, because about 75-90% of adult Ukrainians suffer from disbacteriosis

Standby status

Industrial tests of technology have been carried out at enterprises of this field. The technology for small-scale production have been proved, regulatory documents drafts have been devised. The technology is ready for implementation



Department of Regulatory and Engineering Provisions and Metrology

112, Kanatna str., Odesa, Ukraine 65039

e-mail: nauka@onaft.edu.ua, www.udhtu.edu.ua, Tel./fax: +38(048) 724-28-75



TECHNOLOGY OF PRODUCING THE DIABETIC FERMENTED MILK DRINKS

Purpose of invention

Technologies of fermented milk drinks for people with diabetes, with the use of probiotic bifid- and lactobacteria of bioactive substances and food fibres have been scientifically proved and devised

Essence of invention

The composition of milk-fat blend for fermented drinks production for diabetic nutrition has been developed. As milk basis, it is recommended to use skim milk or its blend with acid-proof bacteria (for yoghurt production). The relation between dairy, soyameal and olive fats is optimized (5:4:1 respectively), due to it, the relation between EFA:MFA:PFA (1,3:1,0:1,0) meet the nutritiology requirements of diabetic products. Synbiotic complexes for fermented diabetic milk beverage drinks (kefir, lapper milk, acidophilin and yoghurt) with such additives: probiotic lacto- and bifidus bacteria, vitamins and microelements of antioxidant type, food fibre, fructose and β -galactosidase



Diabetic yogurt

Key benefits of invention

The usage of devised complexes provides with low level of easily digested carbohydrates milk drinks, which make them useful for diabetic nutrition. Synergetic effect of antioxidant and bifidogenic properties of shared use of vitamin E, vegetable oil, organic selenium, β -galactosidase and protein concentrate during production of fermented diabetic milk drinks is established. It was experimentally proved that these fermented milk drinks can be produced without modernization and reconstruction of the existing enterprise milk factory

Intellectual property protection status

4 patents of Ukraine have been obtained

Market demand

The market outlet is wide, because more than million people, who suffer from diabetes, are legally registered in Ukraine

Standby status

Recipes, technologies and regulatory documents on production of fermented diabetic milk drinks are made, the industrial tests of devised technologies, ready for commercial introduction, have been carried out



INNOVATIVE PRODUCTION OF ALCOHOL FROM RAW STARCH

Purpose of invention

The devised technology can be used in ethyl alcohol production both for food and technical purposes

Essence of invention

Rational technological parameters of thermo-fermentative treatment of different types of starch-bearing raw material and wort fermentation in energy and resource-saving modes by distiller's soluble recirculation are determined: pH 4,5–5,5 at 58–68°C, which depends on charge stock (I level) and 80–90°C (II level), temperature of fermenting – 32–35°C. The economic effect from improved technology implementing due to fuel economy, artesian water, distillery dreg utilization and the use of cheaper enzyme preparations is 7,17–7,29 UAH/dal with the cost of one gig calorie/ Gcal 1481,1 UAH. Payback time of devised technology implementation is: investment – 0, 15 of a year, discount – 0,73–0,74 of a year

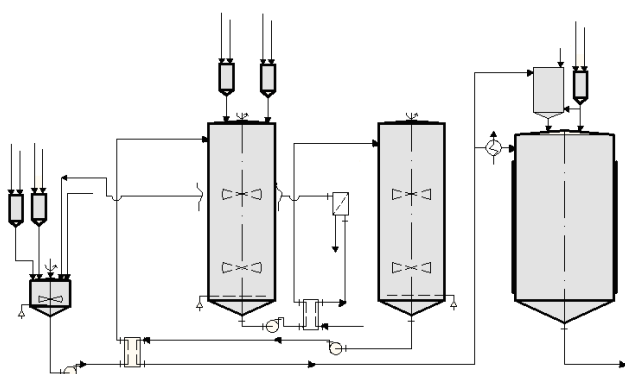

Hardware and technological scheme of the step-by-step thermo-enzymatic hydrolysis of starch-like raw material

Key benefits of invention

The improved technology of ethyl alcohol production cuts process losses in the process of manufacturing reduces mill wastes and energy costs. Besides, the usage of antiseptic is not provided in this technological scheme, because during the work of grain mashes distiller's solubles are used, that reduces pH environment to 4,5–5,5

Intellectual property protection status

8 patents of Ukraine have been obtained

Market demand

Enterprises of alcohol industries can use the devised technology. The received dried distillery waste concentrate can be exported to European Union, because in the process of manufacturing an antiseptic is not used

Standby status

Pilot-scale tests have proved the provision possibility of performance standards of alcohol brew, made from different types of starch-bearing raw material and the rise possibility of finished products exit within law capital input

Department of Intellectual Property

68, Volodymyrska str., Kyiv, Ukraine, 01601

e-mail: info@nuft.edu.ua, <http://www.nuft.edu.ua>, Tel.: +38(044) 287-94-55



BIOTECHNOLOGY OF ORGANICS RECYCLING, USING VERMICOMPOSTING

Purpose of invention and sphere of application

In civilized world after agricultural chemicalization boom the organic management, based on the care of soil life and its role in soil creation, is being developed more dynamically

Intellectual property protection status

2 patents of Ukraine have been obtained

Market demand

A new biotechnology of vermicompost manufacturing helps to increase soil quality in 5–10 times in a short time

Essence of invention

The technology of organic waste utilization with addition of zeolite mineral, which lies in Californian hybrid processing of organic waste, obtaining high-quality environmental friendly biohumus fertilizer is developed. As a substrate, it may be fermented animal, crop, food, wood-based industries wastes etc. The researches with addition of basic substrate of native zeolite mineral (2-6%; the ideal concentration – 2%), with addition of logging debris (black alder – 10-15%) have been carried out. Also there is a possibility to get very valuable supplement feed – worm biomass, which can be used for farm animals, poultry and aquatic organisms feeding

Standby status

The vermicompost stations have been created. The biomass of Californian red hybrid is increasing. The substrate fermentation for creation and the following determination of the most effective proportions of mineral addition, logging debris etc. is being carried out



Scientific and Innovative Activities Department

8/1, Soborna Sq., Bila Tserkva, Ukraine, 09117

e-mail: taras.m.tsarenko@gmail.com, <http://www.btsau.kiev.ua>, Tel.: +38(068) 353-63-69



EQUIPMENT FOR VIBRO-IMPACT DEHYDRATION OF FOOD PRODUCTION WASTES

Purpose of invention and sphere of application

The invention is designed for the usage at the domestic food and processing enterprise for dehydration of moist dispersive wastes and getting valuable additives to agricultural feedstuff or high-calorific fuel from them

Intellectual property protection status

4 patents of Ukraine have been obtained

Market demand

The development is needed for technological activity of food production

Performance-based specifications

The facility with hydropulse drive component for percussion dehydration of distillery stillage, brewer's grain, beet pulp, coffee and barley residual reduces the initial moisture content of 90–95% to final moisture content 20–25%. In the case of three-stage two-component dehydration on the proposed assembly the productivity of dehydrated products 20–25 t/h within power capacity process – 2,7 kW h/t is achieved/ can be provided productivity at dehydrated wastes 20 – 25 t/h under power-consuming of the process 2,7 kW h/t

Standby status

On the basis of vibro-impact IVPM-16 the experimental facility sample with hydroimpulsive drive component for percussion dehydration of food production wastes was created



16 the experimental facility sample with hydroimpulsive drive component for vibro-blowing dehydration of food production wastes is created

Department of Intellectual Property

95, Khmelnytske Shose str., Vinnytsia, Ukraine, 21021

e-mail: vntu@vntu.edu.ua, <http://vntu.edu.ua>, Tel.: (0432) 56-08-48, fax: (0432) 46-57-72



TECHNOLOGY OF OBTAINING THE COLLAGEN FROM PROTEIN-CONTAINING WASTES OF LEATHER PRODUCTION

Purpose of invention and sphere of application

The invention deals with collagens, the wide use of which in medicine, biotechnologies, cosmetic and food industries is conducted by distinctive immunogenic inferiority. The substantial demand at that biotechnological product leads to continuous state of exploration of various manipulations with raw material for collagen obtaining

Essence of invention

The devised technology for collagen obtaining from wastes of leather production is characterized by optimal time extraction, absence of harmful admixture and a great amount of product. After non-collagen emission the collagen extraction with the help of acetous acid has been carried out. The collagen extraction dynamic on the main stage of extraction has been examined. The product purity is confirmed by the results of polyacrylamide gel electrophoresis, and the amount of the obtained protein is calculated with the help of the modified Lowry protein assay

Proteins with molecular weight are obtained – \approx 110, 117, 120, 235 and more. The existence α 1(I) of monomeric units, β 11(I), β 12 (II) – dimeric units, γ (I) (different combinations) trimeric units. Collagen that was extracted in 24 hours is characterized by bigger frequency because of smaller observation ground. Protein analysis in supernatants has discovered the possibility of obtaining of further hydrolysis for low-molecular unit fragments

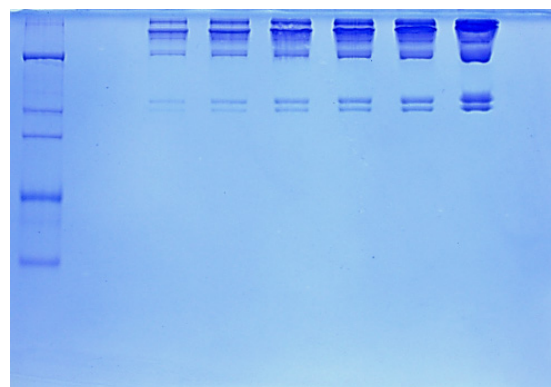

Intellectual property protection status

An application for a patent of Ukraine has been submitted

Market demand

The invention can guarantee quick and cheap collagen obtainment. The devised technologies can be used by cosmetic, pharmaceutical, food industries of Ukraine for the purpose of the output of commercially viable high-quality production with various functions on the basis of collagen

Standby status

The R&D product is at the stage of factory searching for its implementation

Department of Intellectual Property

2, Nemyrovych-Danchenko str., Kyiv, Ukraine, 01011

e-mail: nds@knutd.edu.ua, <http://knutd.edu.ua>, Tel./fax: +38(044) 280-16-03



NATURAL LEATHER WITH THE USE OF MODERN POLYMER MATERIALS

Purpose of invention

The invention deals with new technologies, which provide competitive natural leather materials by more rational use of material, raw material and energy resources and also have less negative environmental impact



Essence of invention

The technological parameters of derm treatment with polymeric materials of new generation on the basis of acrylic and maleinic acids at the stage of tannage and liquid finishing in leather production of modern assortment from different kinds of raw materials

Key benefits of invention

Benefits of vestimentary leather manufacturing techniques with the use of modern polymeric materials at the stage of mineral tannage are the cost reduction of scarce mineral and organic tanning materials, improvement of consumer, hygienic and cutting properties, reduction of ecological and energy load on environment

Intellectual property protection status

2 patents of Ukraine on utility model have been obtained

Market demand

The devised technologies can be implemented at the enterprises, focused on natural leather production

Standby status

Production tests have been carried out, the development is ready for industrial implementation

Department of Intellectual Property

2, Nemyrovych-Danchenko str., Kyiv, Ukraine, 01011

e-mail: nds@knutd.edu.ua, <http://knutd.edu.ua>, Tel./fax: +38(044) 280-16-03



LEATHER MANUFACTURING WITH THE USE OF MONTMORILLONITE DISPERSIONS TECHNIQUES

Purpose of invention

The R&D product deals with technologies, which provide structure formation and service characteristics of leather, using modified montmorillonite dispersions in tannic and after-tannic processes, designed for leather purpose of different purposes production, including shoe upper part, clothes and notions

Essence of invention

Composition materials on the ground of aggregately stable anionic and cationic montmorillonite dispersions, which usage in tannic and after-tannic processes of leather production provides with high-quality structure formation and leather service characteristics improvement have been received. Technical processes of tanning, filling, dyeing and emulsion oiling of semi-finished leather in leather manufacturing for shoe upper part

Intellectual property protection status

9 patents of Ukraine on utility model have been obtained

Key benefits of invention

New technologies help to improve the use of rawstock by 3,1–5,0%, quality of end product by 5–7%, to give the opportunity to reduce the cost of chemicals, to create a greater variety of materials for leather production, to change, either in part or in whole, the usage of environmentally harmful chromium compounds, to achieve the import phase-out of syntan, tannin and tanning oil in after-tannic processes

Market demand

The devised technologies can be used by leather enterprises of Ukraine in order to produce commercially viable leather products of a high-quality and promote green production of leather

Standby status

The R&D product has been practically approved and is ready for implementation

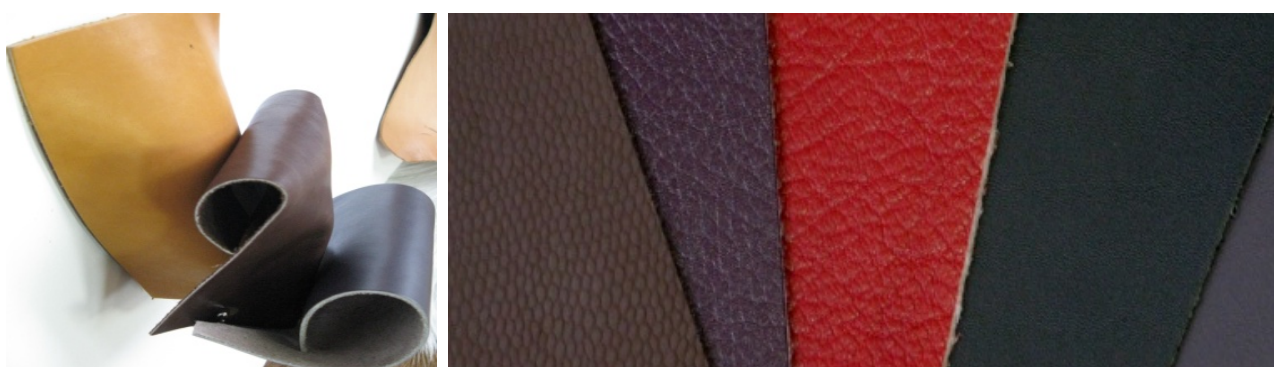

Department of Intellectual Property

2, Nemyrovych-Danchenko str., Kyiv, Ukraine, 01011

e-mail: nds@knutd.edu.ua, <http://knutd.edu.ua>, Tel./fax: +38(044) 280-16-03



COMPOSITE COATING FOR LEATHER WITH HIGH ADHESIVE PROPERTIES

Purpose of invention

The invention deals with the usage of polymer compounds with high adhesive properties, that are applied on leather of modern assortment with retained natural grain side, designed for manufacturing of leather consumer goods (shoes, clothes, notions)

Intellectual property protection status

5 patents of Ukraine on utility model have been obtained

Standby status

Process regulations of structurally painted polyurethanes and dispersions, based on them, and also varnished aniline leather finishing with the help of solutions and dispersions of structurally painted polyurethanes have been developed

Essence of invention

New polymeric compounds are received – they are structurally painted polyurethanes, which cause major improvement of coatings adhesion to leather, and also high leather technological and service factors that provide comfort and long-term usage of garments. The devised technologies of leather finishing with the help of blends, based on polymeric materials with high adhesion properties, provide with different kinds of high-quality coating formation on leather of modern assortment

Market demand

The devised finishing technologies can be used at leather factories of Ukraine in order to produce competitive products of high quality



Department of Intellectual Property

2, Nemyrovych-Danchenko str., Kyiv, Ukraine, 01011

e-mail: nds@knutd.edu.ua, <http://knutd.edu.ua>, Tel./fax: +38(044) 280-16-03



HYDROPHOBIZED LEATHER

Purpose of invention

Leather with common oiling absorb water and leak it easily. Such leather materials cannot be used for military and products for work. The developed blend and hydrofobisation method of leather front, tufted and fur materials for uncovered sheepskin products allows to manufacture products with water-repellent properties

Performance-based specifications

The developed hydrofobisation of leather front, tufted and fur materials for uncovered products is characterized by high physical and mechanical performances, for instance, leather, made from bovine cattle raw material has unit strength of 20–24 mPA, and extensibility at the load of 10 mPA is about 22–29%

Key benefits of invention

The most important indicator of natural leather and fur materials, apart from their physical and mechanical performances, are their cold-resisting properties, which become lower due to product soaking. Hydrofobisation of products gives the ability of high fastness to water which in terms of getting wet in dynamic service conditions is 3–4 hours. Mass of tufted materials (fur velour, woolskin) rises only by 0,2–0,5% after sprinkling. Besides, products preserve sufficiently high sanitary measurements – porosity and vapor transmission by about 2,0–2,3 dm²/(sm²/h) and 2,1–2,6 mg/(sm²/h), that facilitates the stabilization of products cold-resisting properties during their high elasticity

Market demand

Natural hydrophobized leather and fur materials can be used for production of military and working shoes, made for extreme conditions, and also for open products, ultimately woolskin (sheepskin coats, hareskin coats)

Intellectual property protection status

4 patents of Ukraine on utility model have been obtained

Standby status

Water-repelling leather with the use of proposed method, are produced at the enterprise PJSC "Chinbar" (Ukraine) with the trade name "Vodogray"



Department of Intellectual Property

2, Nemyrovych-Danchenko str., Kyiv, Ukraine, 01011

e-mail: nds@knutd.edu.ua, <http://knutd.edu.ua>, Tel./fax: +38(044) 280-16-03

2. Science for Security and Defence





UNMANNED AIRCRAFT SYSTEM "SPECTATOR"

Purpose of invention

The invention is designed for reconnoitering, monitoring of water files and forestlands, oil lines and gas pipe lines, frontier, carrying out search and rescue operations as well as for aerial photographing

Key benefits of invention

Battle performances of remote controlled air system (RCAS) gives the opportunity for hand-launched takeoff, in case of absence of the special launching pad and add-on devices for takeoff operation. Receiving range of data transfer from RPAS – by 30 km. RPAS transportation can be carried out by soldiers in backpacks or containers (the weight is less than 9kg). Parachute system of landing (wheels-up landing is possible), autonomous escape system and RCAS search system are provided

Intellectual property protection status

4 patents of Ukraine have been obtained

Essence of invention

Wingspan – 3020mm, length – 1345mm, flying airspeed – 40-120 km/h, maximum flying height – 2000 m, flight endurance – 120 min; payload weight – 1,5 kg; maximum take-off mass – 7,0 kg; power unit type – electric, radius of action with/ without information transmission – 30/50 km; demand modes - automatic, semi-automatic, manual

Market demand

The invention is demanded by the industrial-military system, for performing rescuing activities and in agricultural industry

Standby status

Industrial production in cooperation with OJSC "Meridian" named after S.P. Korolev. R&D product is actually used by the Armed Forces of Ukraine, the State Border Guard Service of Ukraine, in agrarian sphere of Ukraine



Department of Intellectual Property and Commercialization of R&D Products

37, Peremohy ave., Kyiv, Ukraine, 03056

e-mail: patent@kpi.ua, <http://www.kpi.ua>, tel./fax: +38(044) 236-40-56



MOBILE UNMANNED AIRCRAFT SYSTEM M-10 “EYE 2”

Purpose of invention and sphere of application

The mobile unmanned aircraft system M-10 “Eye 2” is designed to complete such tasks: air-delivered remote observation, air-delivered monitoring of ground situation in case of emergency; search and rescue activities, online telemetry and video data link. The potential users of UAV are civil airlines, security agencies and specialized structures of Ukraine

Essence of invention

An unmanned aerial vehicle (UAV) M-10 “Eye 2” has the form of single-engine cantilever medium-sized plane with a V-tail unit. The airframe is made of fiberglass and carbon fibre, certain structural members subjected to load are made of aluminium high-strength alloys. Main technical characteristics of M-10 “Eye 2” are the following: maximum gross weight – by 4, 95kg, payload weight – by 0,8 kg; mission time – by 120 min., mission time – by 2000 m, online video transmission range – 22 km, data highway – digital, protected; control system type - semi-automatic/ automatic

Key benefits of invention

The capacity for without- aerodrome base gives the opportunity to use M-10 “Eye 2” practically in all conditions of allocation. Due to structural features and small size, UAV M-10 “Eye 2” has low optical, acoustical and radar signature. Heavy load per wing unit area allows to keep upper performance value of wind component up to 22 m/c. Its world analogues are: Draganfly Tango; Micropilot CropCam (Canada); EMT Aladin (Germany); Aeronautics Orbiter, IAI Bird Eye 400 (Israel) and others

Intellectual property protection status

4 patents of Ukraine have been obtained

Market demand

The Ukrainian market is capable to implement M-10 within 100–150 complexes, one part of which may be used by civil airlines, and another – by special services. The world market capacity for M-10 constitutes 700–1000 complexes

Standby status

Preliminary and verifying departmental tests of the exploratory prototype have been carried out, including tests in ATO zone



Scientific and Production Centre of Unmanned Aviation “Virazh”

1, Kosmonavta Komarova ave., Kyiv, Ukraine, 03058
e-mail: nvcba@nau.edu.ua, <http://uav.nau.edu.ua>, tel.: +38(044) 406-71-47, tel./fax: +38(044) 406-71-54



POLYCOPTER NAU PK-08

Purpose of invention and sphere of application

The polycopter NAU PK-08 – unmanned aerial vehicle (UAV), designed for aerial photography, map-making, video monitoring in real time, point objects patrol etc. The potential users of UAV are civil airlines, security agencies and specialized structures of Ukraine

Key benefits of invention

The main benefit of NAU PK-08 is its small dimension in stowed position, and also a high level of overhaulability in the field environment. World analogues of devised UAV are: Aeryon (Canada) and AR-100B (Germany)

Standby status

Implementation stage: attempted operation, procedures of an Aircraft Type certification in State Aviation Administration of Ukraine. PK-08 samples were supplied to the Armed Forces of Ukraine and to ATO zone

Essence of invention

All up weight – by 4 kg.
 Weight-lift ability – by 1,5 kg.
 Flying range – by 30 min.
 Mission length – by 4 km.
 Operational height – by 500 m.
 Operational speed – by 30 km/h.
 Beam quantity – 6.
 Special feature – folding.
 Takeoff position/landing – semi-automatic automatic.
 Standard payload – gyrostabilized CCD-camera

Market demand

After getting a certificate of NAU type PK-08 can be demanded on the Ukrainian market in amount of 500-1000 units and on the world market in amount of 1000-5000 units

Intellectual property protection status

4 patents of Ukraine have been obtained



Scientific and Production Centre of Unmanned Aviation “Virazh”

1, Kosmonavta Komarova ave., Kyiv, Ukraine, 03058
 e-mail: nvcba@nau.edu.ua, <http://uav.nau.edu.ua>, tel.: +38(044) 406-71-47, tel./fax: +38(044) 406-71-54



HYBRID QUADCOPTER

Purpose of invention

A quadcopter is designed for automatic monitoring and technical objects scanning, which includes power lines, oil-and-gas pipeline and storage areas; small freight deliveries to points of difficult approach; secured objects observation; chemical and biological working of agriculturally used areas

Key benefits of invention

Quadcopter navigation aid is a small-scale self-sufficient electronic data system, which frequently generates value of angle rate and acceleration in real-time, orientation angles, line speed and geographic positions, needed for automatic control by vehicle movement. The devices accomplish a function of inertial and satellite information integration and present data with better characteristics, than certain inertial and satellite systems. The quadcopter is a flight facility of a hybrid type, which combines a range of electric motors, internal-combustion engine and generator for trickle charging

Essence of invention

Navigation system: size <10 cm; 3 gyroscopes (IMU STMicroelectronics LSM9DS1TR); 3 accelerometers; 1 receiver (GPS receiver EB-800A); accuracy in autonomous mode: with satellite signal – distance error < 5m, without satellite signal – flight endurance is less than 20 min, distance error -150 m. Hybrid quadcopter: weight – 14 kg (including ICE with plenty of propellant/ fuel; flight endurance – by 1,5 h; useful load – 5-6 kg

Intellectual property protection status

2 patents of Ukraine on utility model have been obtained

Market demand

The importance of innovation is determined by the market demand for the modern navigation aids and first of all for mobile facilities of different purpose

Standby status

Navigation system demonstration is being carried out and the process of testing has been started. The prototype of a hybrid quadcopter is ready



Navigation system



Hybrid drone

R&D Department

2, Kyrpychova str., Kharkiv, Ukraine, 61002
e-mail: nti@kpi.kharkov.ua, <http://www.kpi.kharkov.ua>, tel./fax: +38(057) 707-62-13



UNMANNED LOITERING MUNITION M-56 “MODULE”

Purpose of invention and sphere of application

M-56 “Module” refers to electrically-powered unmanned aerial vehicles with takeoff mass – to 20kg. They are used for aerial inspection/ patrol of an area in order to prevent enemy objects by detecting and destroying them. The potential users of UAV are power and specialized structures

Key benefits of invention

One of the main benefits of M-56 “Module” - repetitive run of “fighting performance” during one flight operation, which no competing vehicle is capable of. Besides, because of a typical generic structure of load-carrying element (fuselage), M-56 “Module” can undergo modification easily due to usage of various airfoils (wings). Flight software has some AI (artificial intelligence) elements. The rival product at the market is the loitering munition Orbiter 1K (Israel)

Market demand

The market for M-56 “Module” is global military market. In Ukrainian market M-56 can be used within 300-500 complexes, and in the world market – within 5000-7000 complexes, depending on essential development modifications

Essence of invention

M-56 “Module” functions as a patroller, that protects the area from invasion. The vehicle is an “intelligent” one: it identifies a target type by itself and/or decides to strike, or “asks” the ground: “What should I do next?” Moreover, M-56 “Module” is a high-precision weapon + scout + artillery fire corrector. There are ammunition supplies at the board. On-board computer has a software for “intellectual” work: recognition and identification of targets, optimum height choice of aerial inspections, terrain avoidance etc. Having completed the task, M-56 “Module” returns “home” and lands under parachute.

Basic technical specifications of M-56 “Module”: wing span – 4,58 m; maximum take-off all-up weight – 13 kg, payload weight – 4kg, flight endurance – 4h, technical radius of action – 120 km, enroute range/distance – 246 m

Intellectual property protection status

It has been applied for a patent of Ukraine on a utility model

Standby status

Pilot-line production and preparation for ground and flight testing are being lasting



Scientific and Production Centre of Unmanned Aviation “Virazh”

1, Kosmonavta Komarova ave., Kyiv, Ukraine, 03058

e-mail: nvcba@nau.edu.ua, <http://uav.nau.edu.ua>, Tel: +38(044) 406-71-47, Tel./fax: +38(044) 406-71-54



MOBILE UNMANNED AERIAL COMPLEX M-57 “SVITANOK”

Purpose of invention and sphere of application

Unmanned complex M-57 “Svitnok” is designed for video surveillance and photographing of linear and plane objects. The potential users of UAV are power and specialized structures of Ukraine

Key benefits of invention

UAV M-57 benefits are low materials intensity, optical, acoustic and radar visibility. It also has a high level of maintainability in the field conditions and can be used in battle actions conditions

Market demand

M-57 can be used within 50–100 complexes in the Ukrainian market, the part of which can be used by the civil services, and another part – by the special services

Essence of invention

M-57 “Svitnok” – an all-wing design unmanned aerial vehicle (UAV) of high-fineness ratio with color video camera.

Basic technical specifications of UAV:

Maximum take-off mass – by 10 kg;

Payload weight – by 2 kg;

Flight endurance – by 180 min. with the use of lithium polymer batteries;

Maximum flying speed – 120 km/h;

Maximum flying height – by 3000 m;

Control system type - semi-automatic/ automatic;

Takeoff position - hand-launched with the help of rubber buffer; landing – with the use of a parachute;

Radius of action – by 70 km

Standby status

The produced model currently undergoes factory tests



Scientific and Production Centre of Unmanned Aviation “Virazh”

1, Kosmonavta Komarova ave., Kyiv, Ukraine, 03058

e-mail: nvcba@nau.edu.ua, <http://uav.nau.edu.ua>, tel.: +38(044) 406-71-47, Tel./fax: +38(044) 406-71-54



TECHNOLOGY OF DISCRETE STRENGTHENING OF PARTS OF SPECIAL PURPOSE MACHINES

Purpose of invention

The creation of a new-generation of vehicles for military and civil usage with high tactical and technical characteristics (TTC) due to development and batch manufacturing for advanced motors and devices completing, on the basis of development and application of a range of advanced technologies for strengthening of working areas

Intellectual property protection status

23 patents of Ukraine on utility model have been obtained

Standby status

The R&D product is ready for production and use

Essence of invention

The conceptually new engineering solutions, to ensure high TTC of military and civil technics due to high reliability and component life of high load steam of engines and machine aggregates, strengthened with the help of created new-generation technologies are the basis of this invention. Due to this, a range of high-technology strengthening methods have been put in manufacturing (production and repair process) of military and civil technics. In comparison with traditional ones, these methods crucially improve a resource (in two-three times), durability and strength, reduce friction and run-out losses (in 1,5-2 times). The proposed technologies differ from known ones by their surface editing methods and modes, their usage, for instance, for high-powered engine crankshafts, increase the resource by 40% with simultaneous expenses decrease on their production by 70%. The production of a range of engines for military and civil technics with improved TT and ES has been created and set up, which includes series of internal combustion engines modernization, the creation of strategic sites self-contained power aggregates and for main-line diesel locomotives etc.

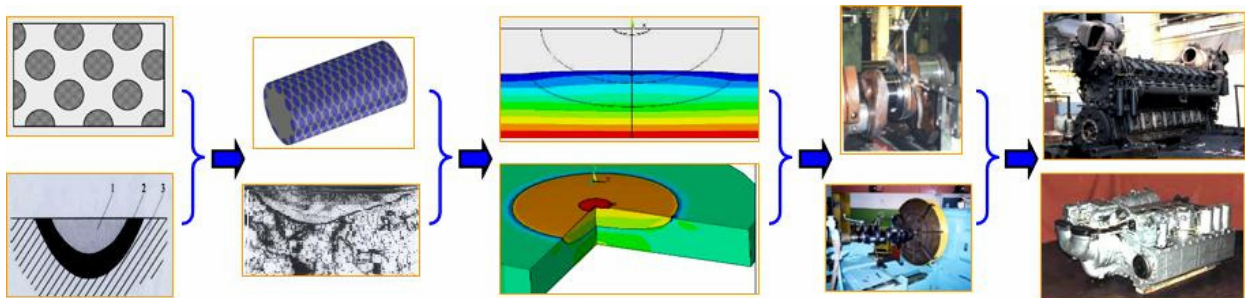

Military and civil vehicles on the base of high-technology solutions for engines and aggregates

R&D Department

2, Kyrpychova str., Kharkiv, Ukraine, 61002
e-mail: nti@kpi.kharkov.ua, <http://www.kpi.kharkov.ua>, tel./fax: +38(057) 707-62-13



COMBINED TECHNOLOGY FOR STRENGTHENING TREATMENT OF SPECIAL-PURPOSE ITEMS

Purpose of invention and sphere of application

The R&D product allows manufacturing of various bulky high-strength steel products, such as tank gun barrels and various artillery and small-arms weapons systems that operate under high gas pressures and are prone resistant to abnormal wear and corrosion; total performance ≥ 500 shots



Research facilities for applying of the functional coating onto the working surface

Essence of invention

Integrated development makes it possible to achieve maximum thickness of barrel walls of ≥ 100 mm with proportional limit of over 1400 MPa after full heat treatment, as in items manufactured in NATO countries. There have also been developed structural and technological equipment parameters, as well as combined processing modes for application of the protective coating on the entire surface of bulky products (chromium, tantalum, etc.) and further thermal treatment. Pilot testing has shown the possibility of applying chromium coating onto almost the entire surface of the manufactured workpiece that significantly enhances its operational lifetime

Market demand

The product has undergone rigorous scientific and industrial testing with application of chromium coating in Yuzhnoye State Design Office (Dnipro) and can be implemented at Ukrainian machine-building and metallurgical plants to satisfy a public sector need for tank gun barrels

Intellectual property protection status

6 patents of Ukraine have been obtained



TECHNOLOGY OF MISSILE RADOME MACHINING USING NEW CONSTRUCTION MATERIALS

Purpose of invention

The R&D product is aimed at enhancing the efficiency of machining process – diamond grinding of thin-walled structures of complex shape, such as radomes and aircrafts made from brittle non-metallic materials, including new and advanced industrial materials - glass-ceramics KS-418

Essence of invention

The invention applies new machining methods for innovative materials such as glass-ceramics KS-418, that has better technical performance and machinability than other glass- and quartz ceramics previously used for that purpose. Glass-ceramics, owing to its unique physical properties and structure, makes it possible to reduce costs needed to process the workpieces by 30% while optimization of machining parameters ensures that the defective layer and water-absorbing capacity of the material will be reduced. As a result, technical characteristics of radomes will significantly improve. The developed technology, including the method of defective layer control of KS-418 material damaged during the machining, may reduce the manufacturing cost of radomes by 25 %

Intellectual property protection status

3 patents of Ukraine have been obtained

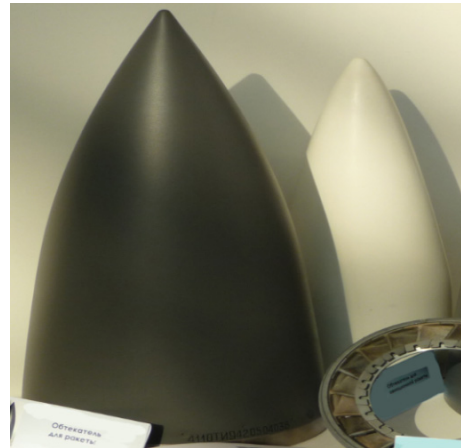

A sample of machined workpiece – the main radio-transparent missile radome

Market demand

The R&D product can be used at enterprises engaged in processing products made of brittle non-metallic materials. The plants that manufacture missile radomes might take a great interest in the invention

Standby status

The technology of machining of small-size thin-walled radomes of complex shape made from glass-ceramics KS-418 was tested under industrial conditions during the production of sample radomes, it is expected to make annual profit

R&D Department

2, Shibankova sq., Pokrovsk, Ukraine, 85300
e-mail: dntu-nich@i.ua, <http://donntu.edu.ua>, tel.: +38(050) 560-55-65



DIGITAL CORIOLIS VIBRATORY GYROSCOPE FOR STABILIZATION AND GUIDANCE SYSTEMS

Purpose of invention and sphere of application

Coriolis vibratory gyroscope (CVG) is one of the latest gyroscopic technologies existing in the world market. The R&D product is able to measure absolute angular velocity and rotation angle and being a part of stabilization and guidance systems measures the routing, roll and pitch of moving objects and platforms in the fields of aviation, astronautics, onshore and off-shore facilities for different purposes

Essence of invention

Measuring range: 200, 400 deg/s
 Bandwidth: 100 Hz
 Temperature range: from 40 to +75 C
 Operating shock: 2ms for 400 g
 Mean time between failure: 500000 h
 Voltage supply: 15–30 V
 Power consumption: <2.5 W†
 Interface: RS-485, RS-422
 Output data: average angular velocity and temperature (6-byte floating point), 600 Hz or 1 kHz

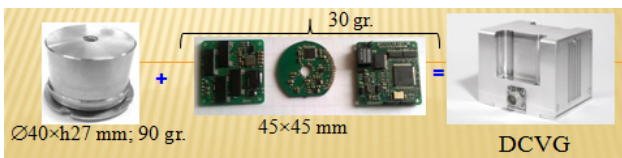

Single-axis unit

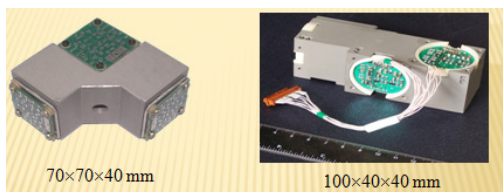

Three-axis variants

Key benefits of invention

Digital CVG is a highly-reliable and, at the same time, a low-cost device of broad application, capable of operating under harsh environmental conditions. The key benefit the R&D product is that it makes it possible to manufacture low-cost resonators made from alloy that have fixed resonant frequency and high Q-factor. The accuracy of CVG is as good as that of competing technologies, while reliability is significantly higher, owing to the usage of rotating metal-wall resonator

Intellectual property protection status

A patent of Ukraine has been obtained

Market demand

The developed digital CVG can be widely used both in Ukraine and abroad

Standby status

The pilot lot has been manufactured and tested

R&D Department

1, Kosmonavta Komarova Ave, Kyiv, Ukraine, 03058
 e-mail: vtnik@nau.edu.ua, <http://nau.edu.ua>, tel.: +38(044) 406-71-56, fax: +38(044) 406-79-21



SPECIAL-PURPOSE SEISMIC VIBRATION SENSOR

Purpose of invention

The R&D product is a compact seismic vibration sensor based on filamentary crystals of silicon that can be used to detect ground targets, including moving objects, such as a military personnel or armoured vehicles, and to determine coordinates of the target object, its direction and speed

Essence of invention

Signal measurement range: $\pm 1,2$ g
 Transformation coefficient: 6 V/g
 Frequency range: 0–800 Hz
 Dynamic range (bandwidth of 100 Hz): 100 Db
 Temperature range: from -60 to +100 °C
 Nonlinearity: ± 0.15 %
 Power supply voltage: 6–15
 Weight: 350 g



Key benefits of invention

Extremely high mechanical strength of filamentary crystals of silicon; irradiation stability of up to $E \leq 10$ MeV; weak dependence of the sensor's output signal on the magnetic field up to 14 T

Intellectual property protection status

2 patents of Ukraine have been obtained

Market demand

Special-purpose seismic vibration sensor can be used to protect high-value objects; to detect moving objects, determine their type (with the purpose of classification) and coordinates; to create a system working under strong electromagnetic fields

Standby status

Pilot version is available; schematic diagrams have been developed

R&D Department, Marketing and Innovation Department

12, Stepana Bandery Str., Lviv, Ukraine, 79013
 e-mail: transfer@lpnu.ua ; <http://lp.edu.ua> , +38 (032) 258-25-34 tel.: +38 (032) 258 25 34



COMPONENT PARTS OF MICRO-INJECTOR FOR RADAR EQUIPMENT

Purpose of invention

Micro-injector for radar equipment provides circulation in close circuits for tightness control systems

Market demand

There is an urgent need for inventions that would enhance heat and wear resistance, reduce friction and, thus, improve the operating reliability of special-purpose equipment

Intellectual property protection status

The R&D product is protected with 12 patents of Ukraine

Key benefits of invention

There have been developed new composites based on aromatic polyamide, filled with a mixture of carbon fibres and graphite, which possess better operational characteristics. Due to military equipment specifications (high loads, speed, exposure to dust, high temperatures, long-term work, harsh environment) and operational reliability requirements on which human lives depends, a comprehensive study of the obtained materials properties was undertaken. Graphite-reinforced plastics, carbon fibre-reinforced plastics and composites containing hybrid fillers rank over base-type plastics, by thermal stability at 35–250 degrees, heat and thermal conductivity, thermal linear expansion coefficient in 1.2–4.2 times and durability in 1–2 times, while reducing the coefficient of friction in 2.6–4.5 times

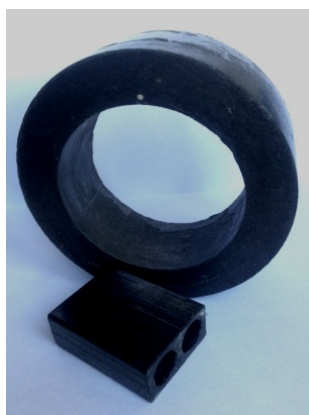

Component parts of the micro-injector
MK 10-1 (rotor 90 × 60 × 34, plate)

Standby status

Industrial testing has shown fail-free operation of the R&D product, and, thus, can be successfully implemented

R&D Department, Department of R&D Information Support

2, Dniprobudivska str., Kamianske, Ukraine, 51900

e-mail: science@dstu.dp.ua, <http://www.dstu.dp.ua>, tel./fax: (0569) 50-63-37



FIRE-RESISTANT COATING FOR BUILDING CONSTRUCTIONS OF FLAMMABLE AND EXPLOSIVE SUBSTANCES STORAGE BUILDINGS

Purpose of invention and sphere of application

The purpose of the invention is to provide fireproofing protection of wood-framed constructions on exposure to incendiary agents (liquid and metalized). Fire-retardant coatings might be a perfect solution to weapons and ammunition storage units, construction companies, the divisions of State Emergency Service and the Ministry of Defense of Ukraine

Essence of invention

The developed fire-retardant coating converts wood in the group hardly combustible materials, having low smoke emission and toxicity. The most important indicator is a slowdown of the destruction process, decomposition and active combustion of wood, isolation from the direct exposure to flame and air access, combustion intensity and heat conductivity of the materials, reduction of the heating rate of explosives and combustible materials above to critical temperature and further progressive destruction by applying fire-retardant coating

Intellectual property protection status

8 patents of Ukraine have been obtained

Key benefits of invention

Under the influence of high-temperature magnesium flame due to its fire-retardant layer, the coating prevents the passage of high temperatures. Wood char depth amounts to less than 1 mm (to compare - a similar fire-resistant coating "Phoenix -DB", that also has good specifications), proved to have the char depth of under 4 mm under the same conditions). The R&D product allows saving money by expanding the raw material base fire-retardant coating on the one hand, and reducing its cost by 2 times on the other hand

Market demand

Fire-retardant coating may be used for treatment of the wooden constructions of the weapon and armament stockage points of the Armed Forces of Ukraine. This coating may also be used for the industrial and civil objects construction

Standby status

Experimental samples are available; technological schemes of production are developed, indoor and outdoor testing is carried out



Testing of experimental samples covered with protective coating, under the influence of magnesium flame.

Research Institute of Road Construction and Engineering Equipment

31, Povitroflotsky Ave., Kyiv, Ukraine, 03680

e-mail: fomin.av@knuba.edu.ua, <http://www.knuba.edu.ua>, tel./fax: +38(044) 245-42-17



REINFORCED CERAMIC AND METAL-CERAMIC COMPOSITES FOR APPLICATION UNDER EXTREME CONDITIONS

Purpose of invention

The R&D product is developed for applications under extreme conditions: high dynamic load rating, heat and intensive abrasive wear

Key benefits of invention

The R&D product is 20% lighter than polymer-ceramic analogues. Other benefits: simple and high performance manufacturing technology; durability, the cost of ceramic elements is two times lower in comparison with hot-pressed analogues. Metal-ceramic reinforced composites have 5 times longer operational lifetime under cutting conditions and are 2 times lighter than traditional ones

Intellectual property protection status

The R&D product is protected with a patent on utility model

Essence of invention

Ceramic or metal matrix composites can be reinforced with fibres from refractory compounds. Reinforced ceramic composites can be used for manufacturing of bulletproof clothing (vests) of the fourth protection level; the weight of body armour plates amounts to 3.5 kg; the strength of metal-ceramic reinforced composites – 900 MPa, plasticity – 18%

Market demand

Effective light armour offers a basic level of human protection and is necessary for all Security Forces of Ukraine and the Ministry of Defence; can be applied to the cutting tools (paper, rubber, plastic), cultivation of land, etc. under extreme conditions of abrasive wear that is necessary for light industries, as well as agricultural purposes

Standby status

According to the results of scientific research, the expected performance-based specifications have been experimentally ensured by manufacturing and testing. The R&D product is available for implementation

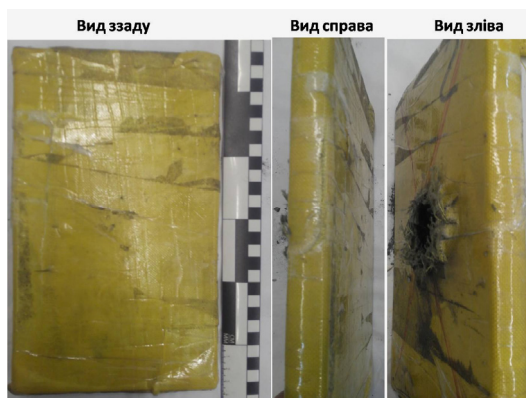

Composite armor plate

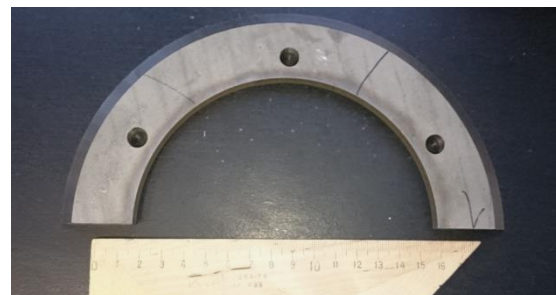

Sector corrugated cardboard cutting knife

Department of Intellectual Property and Commercialization of R&D Products

37, Peremohy Ave., Kyiv, Ukraine, 03056

e-mail: patent@kpi.ua, <http://www.kpi.ua>, tel./fax: +38(044) 236-40-56



SMALL-ARMS FIRE VISIBILITY-REDUCING DEVICE

Purpose of invention

The R&D product may be used as a muzzle mechanical device for small arms to lower the sound of a gun and hide the combustion products of the gunpowder in order to prevent the detection of the rifleman or draw attention to him

Essence of invention

Bore diameter – 5.45/7.62 mm; length – 220 mm; diameter – 45 mm; weight – 400 g; fastening thread – M24 × 1.5; M14 × 1LH; shell material – D16T (anodized), reflectors – stainless steel; complete set: M545-01 device, camouflaged case, key, guidance note

Key benefits of invention

- lowering the sound pressure levels not less than 25 dBA (while using supersonic ammunition);
- significant visibility reduction (muzzle flash, smoke, dust);
- high reliability (upon performing 1500 shots, there were no faults and structural changes of the device details);
- significant cost reduction, owing to enhanced technological effectiveness of the design and advanced machining methods;
- main operational characteristics of gun volume reduction;
- reducing the weight of the device to 400 g

Intellectual property protection status

1 patent of Ukraine has been obtained

Market demand

This R&D product can be applied in the military-industrial complex by small arms manufacturers

Standby status

The R&D product has undergone industrial testing and is currently implemented



R&D Department, Centre of Scientific, Technical and Economic information

2, Rymskoho-Korsakova str., Sumy, 40007, Ukraine
 e-mail: dkurbatov@sumdu.edu.ua, info@cni.sumdu.edu.ua,
 tel./fax: +38(0542) 68-78-69, +38(0542) 33-41-08



MULTICHANNEL SMART ODOR-DETECTING DEVICE

Purpose of invention

Multichannel odor-detecting device (MSRC-1) is designed for rapid analysis and automatic identification of odor concentrations, particularly in cabins of aircraft, space and other military equipment. The database of the determined substances includes approximately 500 chemicals (explosive and toxic substances, lubricating and fuel materials, combustion products, adhesives, alcohol, detergents, perfumes, industrial chemicals, mold, drugs)

Intellectual property protection status

12 patents of Ukraine have been obtained

Market demand

The R&D product can be applied in airport safety and security systems, railway stations, subway stations, aircraft engineering, space technology, chemical industry, mining, automobile transport, medicine, agriculture, environmental monitoring within Ukraine and abroad

Standby status

A pilot version has undergone operational testing; gas concentrations have been calculated

Essence of invention

The R&D product is based on the dependence of reactive properties and negative resistance in semiconductor devices on the influence of external physical quantities and, thus, allows creating of a new class of micro-electronic frequency converters of gas concentrations and identification of odours. Such devices provide the conversion of input data into a frequency signal and increase speed, accuracy and device sensitivity, to expand the range of measured values, to improve reliability, interference resistance and long-term stability of parameters. The device operates in real-time. The range of measured values for various gas-containing compounds is from 2 ppb to 1500 ppm. Measurement error in the range of 2–500 ppb is 2 ppb; in the range of 500–1500 ppb is 5 ppb; in the range of 1,5–50 ppm is 0,5 ppm; in the range of 50–1500 ppm is 5 ppm. The measurement of complex substances concentrations is displayed on the screen, as well as for each sensor separately online



Department of Intellectual Property

95, Khmelnytske Shose str., Vinnytsia, Ukraine
e-mail: vntu@vntu.edu.ua, <http://vntu.edu.ua>, tel.: (0432) 56-08-48, fax: (0432) 46-57-72



NEW FOODS FOR MASS AND SPECIAL CONSUMPTION

Purpose of invention and sphere of application

The R&D products are aimed at the improvement of daily ration for military personnel of the Armed Forces of Ukraine and other military formations, people living and working under particularly hazardous conditions, as well as those, who are engaged in considerable physical activity, suffer from loss of blood and strength, underwent surgical interventions or injuries, recover from physical and psychological stress; for general body strengthening; for child's growth and recovery from serious diseases; during pregnancy and breastfeeding; patients suffering from anemia or cancer; blood donors

Key benefits of invention

Dried fruit and nut mix is included into the daily rations of army personnel all over the world, for example, Power Sport (FAI, Italy) chocolate bar; chocolate, marmalade, a mixture of dried fruits and nuts (BAF, UK); peanut butter, crackers (USA). However, neither in the world nor in Ukraine you may find analogues containing heme iron or organic iodine

Standby status

The developed products are already available

Essence of invention

High-protein and high-mineral products of special consumption in the form of bars contain sustainable protein and organic (heme Fe²⁺) iron, as well as vitamins, antioxidants, microelements, in particular organic iodine. The content of proteins, fats and carbohydrates are optimally balanced. The shelf life of all products is extended and packaging is convenient. Approbation has been carried out in separate units of the National Guard of Ukraine (including field conditions) and hospitals

Intellectual property protection status

5 patents of Ukraine have been obtained

Market demand

This R&D product can be used as a part of field ration for various units of Armed Forces of Ukraine; for athletes and tourists; can be recommended for those who have suffered from radiation and other harmful factors; for the prevention of anemia; for the increase of nutritional value of food rations in Ukraine



VitaBar® Bars: "Fruit BREAD", "Winner", "Algae bar Wakame"

Department of Management and Information (Intellectual Property Commercialization Group)

333, Klochkivska str., Kharkiv, Ukraine, 61051

e-mail: patent@hduht.edu.ua, <http://www.hduht.edu.ua>, tel.: +38(057) 336-74-92



PORTABLE WATER PURIFICATION PLANT "SOVA"

Purpose of invention and sphere of application

The plant is designed to receive purified, biologically and chemically inert, safe drinking water in the field, natural or man-made disaster zones, and battlefields

Key benefits of invention

The R&D product provides the quality of water purification at the world level (USA, Israel). At the same time, it has a lower manufacturing cost, water treatment cost and greater self-sufficiency, compared to modern products existing in the civilian market, it provides much better barrier efficiency (especially considering microbiological and viral pollution) and consequently, not only clean lakes and streams may be used as water sources, but also contaminated springs (swamps, drainage ditches, etc.)



Portable water purification plant "SOVA"



Source swamp water (left) and water purified with the plant (right)

Essence of invention

Due to the use of innovative water purification technology using biocidal polymers, the plant effectively cleans water from organic (pesticides, biological residues, etc.) and inorganic (heavy metals) impurities, disinfects water to kill most disease-causing microorganisms - bacteria (dysentery, cholera, typhoid, tuberculosis, leptospirosis), viruses (HIV, hepatitis, Coxsaks), fungi (candida, aspergillia). The installation does not require an additional external power supply and is highly self-sufficient (one set of consumables is enough for over a month; additional equipment is provided to increase self-sufficiency). One unit can provide a group of a twenty with fresh drinking water - small mobile units (intelligence, special-purpose groups, block posts, landing forces). It can also provide drinking water to civil servants and civilians in an emergency - natural disasters, infectious diseases, man-made disasters, and military actions. Technology can be applied by larger units - hospitals, field camps, military units and towns

Intellectual property protection status

The plant is currently being patented. Several components (reagents and technology) are already protected with the patents of Ukraine

Market demand

The main users of the R&D product can be the Armed Forces of Ukraine, the National Guard, border guards, mobile brigades of the State Emergency Service, and other groups of specialists working in the emergency zones, disaster areas and on military operations directions

Standby status

The R&D product currently undergoes testing procedures

Department of Intellectual Property and Commercialization of R&D Products

37, Peremohy Ave., Kyiv, Ukraine, 03056

e-mail: patent@kpi.ua, <http://www.kpi.ua>, tel./fax: +38(044) 236-40-56



BIOMETRIC-BASED SYSTEM FOR COMPLEX ASSESSMENT OF OPERATIONAL AND PHYSICAL CHARACTERISTICS OF COMBAT KIT

Purpose of invention

The R&D product is aimed at solving the problem of quality control, technical compatibility of elements of a set of combat clothing to boost combat effectiveness of both an individual military servant himself and unit as a whole

Essence of invention

The system receives and collects real-time data from under clothing device at a distance of 5 km to the subject. Data updates up to 20 times per second, using 104 sensors (temperature, relative humidity, pressure, accelerometer, gyroscope and magnetometer)

Key benefits of invention

The development and testing of a new complex differential method for combat kit assessment, taking into account the military occupational specialty and seasonality will help to accelerate the process of experimental testing of combat kit by 45%, as well as provide new data on its interaction with a military servant

Market demand

The system might be in demand in structural subdivisions of Ukrainian Security Forces and civilian economy

Intellectual property protection status

4 patents of Ukraine have been obtained

Standby status

The developed complex includes products with biometric packages, combined with software analytical complex, and is used for accelerated testing of combat kit

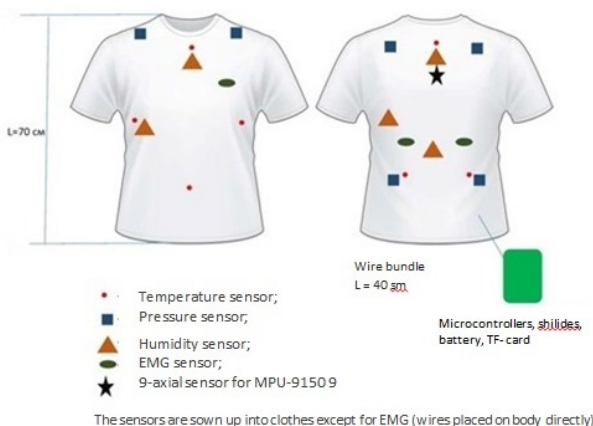

PRINCIPLES OF OPERATION

The worker puts it on, performs the work for 4-5 hours. The data is recorded and transferred to TF-card. Afterwards the data undergoes analysis.

The following data is recorded in .txt format

```
DT / t1 / t2 / t3 / t4 / t5 / t6 / t7 / p1 / p2 / p3 / p4 / p5 / p6 / h1 / h2 / h3 / h4 / h5 / emg1 / emg2 / emg3 / + / - / + / - / + / - / + / - / EKG / Vcc
```

Where DT – time and date / t1-7 – temperature level, p1-6 – pressure level / h1-5 – humidity level / emg1 – EMG level / EKG / V_{cc} – the state of charge
+ / - index on 9-axis sensor

LIST OF SENSORS

SHT75 – Digital sensor of temperature and humidity
SHIELD-EKG-EMG (or Muscle Sensor V3 – in stock)
Axial sensor on MPU 9150 9 / L2GD20H and LSM303
Force Sensitive Resistor – Square SEN – 09376 ROHS (or Piezo Element SEN-10293 ROHS)

Biometric-based system of complex assessment for operational and physical characteristics of combat kit

Department of Intellectual Property

2, Nemyrovych-Danchenko str., Kyiv, Ukraine, 01011

e-mail: nds@knuud.edu.ua, <http://knuud.edu.ua>, tel./fax: +38 (044) 280-16-03



MEN'S OVERALLS FOR MECHANIZED AND ARMoured FORCES PERSONNEL

Purpose of invention

The overalls are designed for a common soldier of mechanized and armed forces

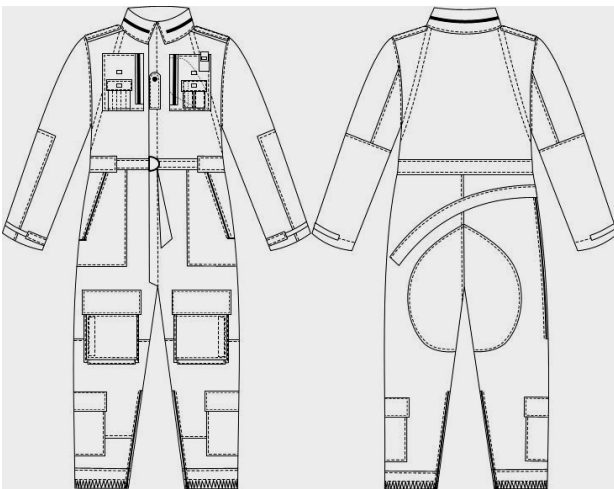

Essence of invention

The R&D product is a pair of modern ergonomic overalls made of heat-resistant textile for the protection of military servants working under harsh conditions, when temperature rises up to 130 °C, and heat flux density increases to 5 kW/m² for 5 seconds. The suggested model is manufactured using original compositional artistic, design and technological solutions and range of materials, fittings, and sewing threads manufactured by leading world and domestic companies

Intellectual property protection status

1 patent of Ukraine on utility model has been obtained

Market demand

The suggested overalls can be used as a part of military clothing



Standby status

Experimental overall models were created in conditions of industrial production and have been successfully tested

Department of Intellectual Property

2, Nemyrovych-Danchenko str., Kyiv, Ukraine, 01011
e-mail: nds@knutd.edu.ua, <http://knutd.edu.ua>, tel./fax: +38 (044) 280-16-03



PROTECTIVE OVERALLS FOR AIRCRAFT RESCUE AND FIREFIGHTING SERVICES

Purpose of invention and sphere of application

The overalls are designed for people involved in emergency aircraft rescue operations of different protection levels and prognosticated reliability indexes



Essence of invention

The suggested overalls provide protection at various levels within the temperature range from -40 up to $+150$ °C, under the action of thermal radiation with a surface flux density of up to 7 kW/m^2 for 5 seconds. Ergonomics is enhanced, owing to a new fastener and back design; the overalls themselves are made from heat-resistant textile.

The effectiveness of wearing protective clothing during a certain period of operation (top material withstands 80-120 washing cycles) has been experimentally proved

Intellectual property protection status

2 patents of Ukraine on utility model have been obtained

Market demand

The suggested overalls can be used by emergency rescue team members and those eliminating the aircraft accidents consequences

Standby status

Experimental overalls models were created under conditions of industrial production and have been successfully tested

Department of Intellectual Property

2, Nemyrovych-Danchenko str., Kyiv, Ukraine, 01011

e-mail: nds@knutd.edu.ua, <http://knutd.edu.ua>, tel./fax: +38 (044) 280-16-03



FIREFIGHTER PROTECTIVE ENSEMBLE

Purpose of invention

A special protective ensemble for a firefighter is designed to protect human body from the influence of dangerous and harmful environmental factors while firefighting/fire suppressing and conducting rescue operations, that corresponds to the second level of operational properties

Intellectual property protection status

1 patent of Ukraine for design has been obtained



Essence of invention

The ensemble can be used within the temperature range from 40 to +300 °C, under the influence of thermal radiation with a surface flux density of 7 kW/m² and short-term thermal radiation effect with a surface flux density of up to 40 kW/m², moderate explosion hazard when exposed to open flame during up to 15 sec., which meets the requirements for the fire-fighting clothing according to current State Standards of Ukraine.

The ensemble provides:

- protection of the firefighter while working under high ambient temperatures of up to 180 °C and the effects of heat flux density of 10 kW/m² during 300 sec.;
- protection against water and surfactant solutions penetration under clothing;
- protection against short-term (up to 5 sec.) thermal radiation effect, which is considered to be equal to exposure to open flame (heat flux density of 80 kW/m²);
- timely heat removal from the clothing space;
- visibility of the firefighter under restricted light;
- protection against bursting and erosion

Market demand

The product is used as a thermal protective special clothing of general type for fire and rescue units of the State Service for Emergency Situations of Ukraine

Standby status

The suggested ensemble was created under conditions of industrial production in the amount of 200 units and supplied to fire and rescue units of the State Service for Emergency Situations of Ukraine

Department of Intellectual Property

2, Nemyrovych-Danchenko str., Kyiv, Ukraine, 01011

e-mail: nds@knutd.edu.ua, <http://knutd.edu.ua>, tel./fax: +38 (044) 280-16-03



HOSPITAL GOWN FOR WOUNDED MILITARY PERSONNEL

Purpose and sphere of application

The R&D product can be used for the wounded military personnel treatment in trauma and burn units

Intellectual property protection status

A patent application has been submitted

Market demand

There is a considerable inconsistency of the existing range of hospital clothing to meet modern maintenance requirements, especially in the intensive care and resuscitation units, thus, there is strong need to upgrade hospital gowns for military personnel

Standby status

The suggested prototypes have been successfully tested by patients of military hospitals and clinics

Essence of invention

The R&D product is an article of underwear set for stretcher cases that, owing to new elements, has improved operational properties, facilitates dressing and undressing processes, and provides free access to different parts of the body during medical procedures and therapeutic manipulations. The piece of clothing has front and back sides, which are cross-linked with a help of shoulder seam detach; expanded back seam with triangle-shaped details that are applied to the opposite side of the product and attached together with the help of 'velcro' fastener



Department of Intellectual Property

2, Nemyrovych-Danchenko str., Kyiv, Ukraine, 01011

e-mail: nds@knutd.edu.ua, <http://knutd.edu.ua>, tel./fax: +38 (044) 280-16-03



KNITTED FABRICS FOR PERSONAL PROTECTIVE EQUIPMENT

Purpose of invention

The aim of the R&D product is to create and use the textiles as components of personal protective equipment for military servants and other people from bladed articles, cold steel and firearms effect

Intellectual property protection status

1 patent of Ukraine on utility model has been obtained

Essence of invention

The capability of the knitting machine to process innovational type of raw material - a high molecular weight polyethylene thread; design and manufacturing of smart textiles for knitted products using color-interlacing technique - interlock and double-layer pressed compound with core thread on a double cylinder circular knitting machine. The industrial testing has shown the durability of the knitted fabric during perforation (over 800 N). The designed fabrics withstand the tensile load of 2250 N in length and 1950 N and in width. The established parameters of the knitting mode ensure proper knitting of the stitch

Market demand

The R&D product can fill the existing gap as there is no well-established production of high-strength knitted fabrics in Ukraine; dozens of sewing factories that specialize in the personal protective equipment manufacturing need such textile materials

Standby status

Experimental samples are available

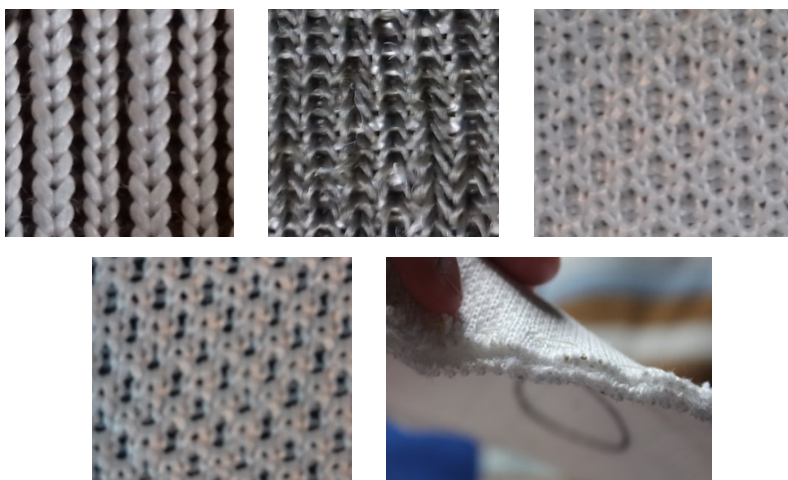

Department of Intellectual Property

2, Nemyrovych-Danchenko str., Kyiv, Ukraine, 01011

e-mail: nds@knuud.edu.ua, <http://knuud.edu.ua>, tel./fax: +38 (044) 280-16-03



MULTILAYER TECHNICAL SPECIAL-PURPOSE TEXTILES

Purpose of invention and sphere of application

The R&D product can be used during pipes installation with factory insulation coatings for oil and gas pipelines; for fuselage transportation; as filters in the coal and sugar industries; in body armor manufacturing both with and without ceramic and titanium armor plates (light series); protective elements manufacturing (sole, sidewalls) of military footwear (combat boots) for protection against anti-personnel mines; in parachute-fabric slings manufacturing for landing systems for military vehicles

Key benefits of invention

The suggested multilayer fabrics have a discontinuous sign-changeable load of 4% and burst stretch by 97% higher than of a steel sheet (steel No. 3) of the same cross-section. Moreover, the productivity of technological equipment is 2.5 times higher while saving material by 12-18%

Essence of invention

Multilayer fabrics model: STSZ - 5M, STSZ - 10M, STSZ - 15MOD, STSZ - 18BZ, STSZ - 25TS

Characteristic features of weave: 5-, 7-, 8-layer interlacing

Sample width: 80 ± 1 mm

Sample thickness: $5.2-9.2 \pm 0.5$ mm

Surface filling: $70-96 \pm 2\%$

Breaking sample load: $80000-140000 \pm 50$ N

Burst extension: $22-64 \pm 3\%$

Intellectual property protection status

15 certificates on invention and patents of Ukraine have been obtained

Standby status

The R&D product is at industrial production stage



Department of Intellectual Property

2, Nemyrovych-Danchenko str., Kyiv, Ukraine, 01011

e-mail: nds@knutd.edu.ua, <http://knutd.edu.ua>, tel./fax: +38 (044) 280-16-03



ELECTROCONDUCTIVE FIBROUS MATERIAL

Purpose of invention

The R&D product can be used in manufacturing of military clothing with anti-static properties, special clothing for EMF protection and can be used as an anti-static supplement for fabrics and polymers

Essence of invention

The suggested electro-conductive fibrous material might be used as a textile static electricity charge neutralizer that reduces electrostatic charge when approaching to the object that moves at a high speed (from 30 to 120 m/ min) or with a rotation (50–300 rpm) (0.5–1 cm) or while touching the textile neutralizer

Type of neutralizer	Specific electrical resistance, ohm · m	Voltage of an electric field, V/cm
Using suggested textile neutralizer	$1,0 \cdot 10^2 - 1,5 \cdot 10^2$	110–150
Without textile neutralizer	$2,9 \cdot 10^2$	3000

Key benefits of invention

The suggested electro-conductive fibrous material allows maintaining sufficient wet resistance and dry friction of treated fibrous materials without using expensive carbon and metallized fibers. Specific electrical conductivity of the developed fibrous material is $1 \cdot 10^{-2} - 1 \cdot 10^2$ cm/m. Layer-by-layer formation of nanoparticles, as a result of self-organization process of polyaniline in the fibrous material, makes it possible to increase specific electrical conductivity to $1 \cdot 10^3$ cm/m

Intellectual property protection status

4 patents of Ukraine have been obtained

Market demand

Textile products for technical and departmental purposes are in demand for the Security Forces of Ukraine

Standby status

The technology for conductive fibrous material has been developed, samples are available

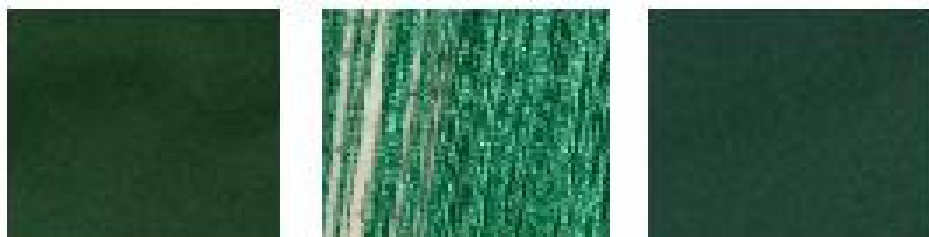

Samples of electro conductive fibrous material

Department of Intellectual Property

2, Nemyrovych-Danchenko str., Kyiv, Ukraine, 01011

e-mail: nds@knutd.edu.ua, <http://knutd.edu.ua>, tel./fax: +38 (044) 280-16-03



MAGNETIC FIBROUS MATERIAL

Purpose of invention and sphere of application

The R&D product might be applied for protective military clothing manufacturing, body armor coatings, bedspreads, as well as for both permanent and temporary shielding of technical devices or protection against microwave radiation as textile protective screens.

Essence of invention

As a result, the determined initial technological parameters allow obtaining the magnitude indicators of saturation magnetization of the magnetic fibrous materials sufficient to acquire the necessary magnetic properties of the fibrous material containing the nanoparticles of iron oxide compounds (magnetite, magnemite). The protective properties of the proposed magnetic fibrous materials are based on intense absorption of the microwaves by the magnetite nanoparticles. The developed materials have saturation magnetization in the range of $2-10 \text{ A} \cdot \text{m}^2/\text{kg}$

Intellectual property protection status

1 patent of Ukraine has been obtained

Key benefits of invention

The main benefit of textile protective screen manufacturing is advanced production technology with relatively low cost of raw materials and the manufacturing process itself; textile materials with magnetic properties allow creating flexible designs of screens and absorbers of electromagnetic radiation. The designed textile screen meets exceptional ease of use, is flexible, durable, air permeable, etc.

Market demand

The R&D product can be applied for textile manufacturing of technical and departmental special-purpose appointments

Standby status

The technology for magnetic fibrous material has been developed, samples are available

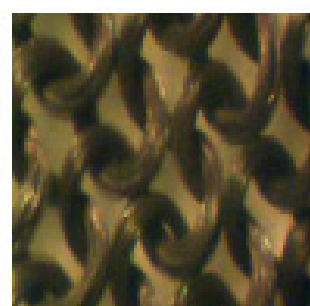

Department of Intellectual Property

2, Nemyrovych-Danchenko str., Kyiv, Ukraine, 01011

e-mail: nds@knutd.edu.ua, <http://knutd.edu.ua>, tel./fax: +38 (044) 280-16-03



COMPOSITE EMF SHIELDING PAINT

Purpose of invention and sphere of application

The R&D product can be applied for solving the problem of electromagnetic compatibility of operating electronic equipment, reducing the electromagnetic visibility of military electronic equipment, protection against the information leakage from electronic devices, meeting rooms, protection against negative health effects of electromagnetic radiation

Key benefits of invention

The invention allows not only to protect electronic devices from electromagnetic radiation, but can also be used for information security systems, in household and special premises, electromagnetic screens and multilayer absorbent materials. The developed paint does not contain toxic substances and provides reliable adhesion to the basis material of different origins (metals, glass, ceramics, plastic)

Essence of invention

The coating reduces the field strength by 100–1000 times (from -20 to -30 dB) within frequency range from 30 MHz to 30 GHz

Intellectual property protection status

A utility model patent of Ukraine has been received

Market demand

The R&D product can be used for thermal imaging and optical instruments, radiation control devices, or any other electronics, especially those that are concentrated in large numbers on small areas

Standby status

The suggested shielding composite paints can be used for production of thermal imaging and optical sights of various types, multifunctional dosimeters-radiometers, etc.



Radiation monitoring device sample
<http://sparing-vist-centr.business-guide.com.ua/>



TSA-9 thermal imager
<http://tvt-thermal.com/ua/>

Department of Intellectual Property

2, Nemyrovych-Danchenko str., Kyiv, Ukraine, 01011
e-mail: nds@knutd.edu.ua, <http://knutd.edu.ua>, tel./fax: +38 (044) 280-16-03

3. Information and Communication Technologies

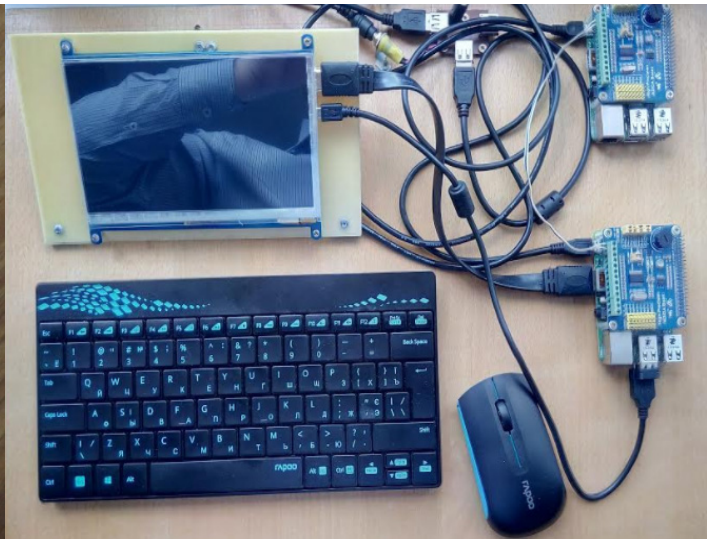
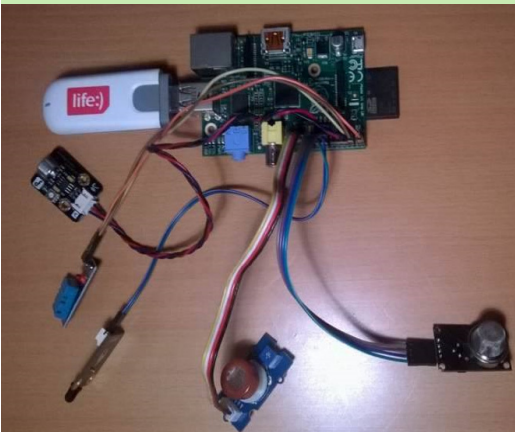



AIRCRAFT AND MACHINE-BUILDING MANUFACTURING OPERATIONS MANAGEMENT

Purpose of application

Informational support contributing to administrative decision-making process during technical preparation, planning and operations management by means of integration of project, production and regulatory reference data, taking into account the enterprise resource pool, its goals and international ISO-Standards

Essence of invention

The R&D product was developed to perform the following: to manage organizational structure of an enterprise; to create integrated informative environment; to consolidate and synchronize projects, productive and planned data in the integrated informative environment; production and planning data administration; to meet standards and maintain normative references; to maintain the database system; to assess and manage decision-making process in the course of work; to manage the processes of technical preparation of production; to manage common design and production projects at separate enterprises

Intellectual property protection status

4 intellectual property certificates of the State Service of Intellectual Property of Ukraine have been obtained

Market demand

Machine-building and aircraft industries with discrete manufacturing, such as: Motor Sich JSC (Zaporizhzhya), ANTONOV ASTC (Kyiv), Novokramatorsky Mashynobudivny Zavod JSC (Kramatorsk), etc.

Standby status

Theoretical and methodological results are gained, experimental software is available

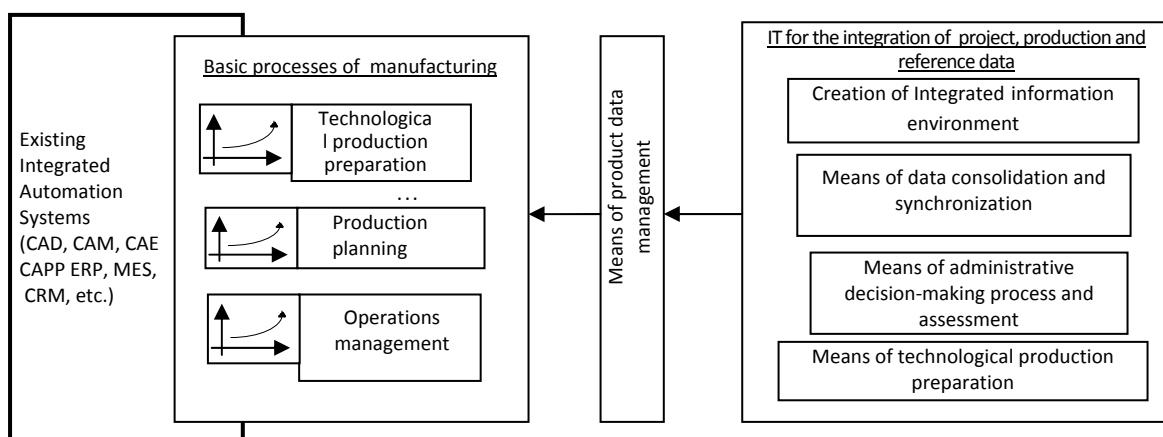

Department of Scientific and Technical Information

1, Kosmonavta Komarova Ave, Kyiv, Ukraine, 03058

e-mail: vtник@nau.edu.ua, <http://nau.edu.ua>, tel.: +38(044) 406-71-56, fax: +38(044) 406-79-21



ON-BOARD SIGNAL PROCESSING DEVICE FOR “SICH-2M” SPACECRAFT MULTISPECTRAL SCANNER

Purpose of invention and sphere application

The R&D product is a charge coupled device for transferring signal charges from photo-sensors and converting them into digital data; the device also controls photo-sensors, generates test and telemetry signals. The similar equipment is used in Earth remote sensing satellites

Essence of invention

Type of the charge coupled device: CCD-191-DC
 Number of the spectral channels: 4
 Spectral ranges: 0,50–0,59; 0,61–0,68; 0,79–0,89; 0,69–0,79 μm .
 Scanning speed, lines/min – 54 000
 Speed of information flow, Mbit/ sec – 184
 Signal-to-noise ratio – over 200 dB
 Number of bits required for the visual signal – 8
 Power consumption – 40 W



Signal processing device for multispectral scanner

Key benefits of invention

The device enables real-time photometric error correction (of photo-sensors) and zone characteristics of scanner lens

Intellectual property protection status

The State Space Agency of Ukraine possesses all supporting documents

Market demand

The R&D product can be used in national spacecraft manufacturing and assembling

Standby status

Pilot model of on-board signal processing device for “Sich-2-1” has already been manufactured and tested. Technical documentation “Sich-2M” spacecraft multispectral scanner is under development

R&D Department, Marketing and Innovation Department

12, Stepana Bandery str., Lviv, Ukraine, 79013
 e-mail: transfer@lpnu.ua; http://lp.edu.ua, tel +38 (032) 258-25-34



PORTABLE TROPOSPHERIC RADIO-RELAY STATION

Purpose of invention and sphere of application

The R&D product is to be applied for special communications to serve the interests of security forces on the daily basis, during counter-terrorist operations, etc.; to enhance operational communication in order to eliminate the consequences of emergencies, natural and man-made disasters; in departmental and corporate networks, in sparsely populated districts and remote areas; to provide communication for trunk and intrazonal networks for commercial telecommunication operators' benefit; to organize top-priority and minor areas of technological and special communication networks

Essence of invention

- The rate of reception/transmission of digital information stream: up to 4 Mbps
- Ethernet connection: 100 VASE-TX, RJ45-IR67 connector and ports capability to encapsulate external E1 converter (G.703) in Ethernet
- Range of operating frequencies: 4.4–5.0 GHz
- Transmitter power output on the antenna flange: over 100 W
- Possibility of automatic discrete (with 1 dB step) output power regulation: over 30 dB

Key benefits of invention

All-level adaptation regime implementation, combined with data packet use, allows controlling the speed of data transmission over a wide range, depending on station's operation. The application of software-defined radio communication, on-chip and embedded Linux operating systems not only enables creation of modern equipment, but also provides station upgrade, owing to up-to-date software. Fundamentally new transceiver is installed in monoblock version, using transistor power amplifiers. The R&D product is in demand on the international communications market. Intellectual property protection documents are in the drafting stage

Standby status

The R&D product can be implemented and its technical parameters can be determined by the customer

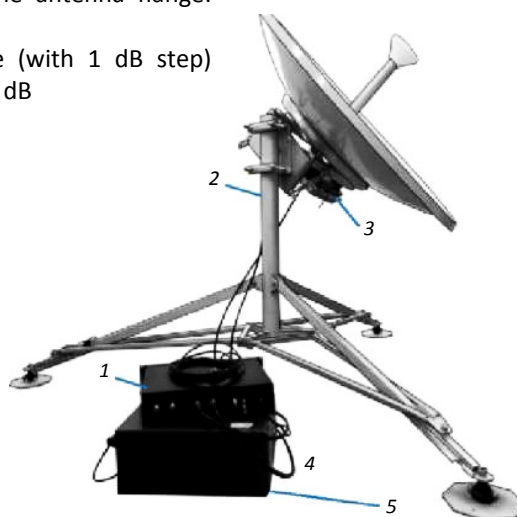

1 – Modem device; 2 – antenna-rotary device; 3 – receiving and transmitting data block; 4 – cable bay; 5 – power supply

Department of Intellectual Property and Commercialization of R&D Products

37, Peremohy Ave., Kyiv, Ukraine, 03056

e-mail: patent@kpi.ua, <http://www.kpi.ua>, tel./fax: +38(044) 236-40-56



DIGITAL MODEM EQUIPMENT BASED ON SDR-TECHNOLOGY FOR NEW GENERATION TROPOSPHERIC STATIONS

Purpose of invention and sphere of application

The R&D product can be implemented at tropospheric communication and radio relay stations of the next generation with increased noise immunity. High data transfer rate is provided by using advanced data transfer technologies and multilevel adaptation to changing operating environments

Essence of invention

Tropospheric scatter bandwidth: up to 50 Mbps
Direct visibility bandwidth: up to 155 Mbps
Error rate: 10^{-6}
OFDM modulation (QPSK, QAM16, QAM 64)
Noise-proof encoding: concatenated code
External interface: Ethernet

Key benefits of invention

- Application of spectrally efficient modulation types and noise immunity coding.
- Multi-level adaptation to changing operating environments by using new technical solutions.
- Support for different modes of operation (tropospheric propagation, diffraction propagation, direct visibility).
- Usage of packet data transmission.
- Continuous non-destructive control of the status of tropospheric communication lines.
- The use of software-defined radio communication (SDR) and on-chip (SoC) systems

Market demand

The R&D product is in demand at tropospheric communication and radio relay stations. Intellectual property protection documents are in the drafting stage

Standby status

The R&D product can be implemented and technical parameters can be determined by the customer

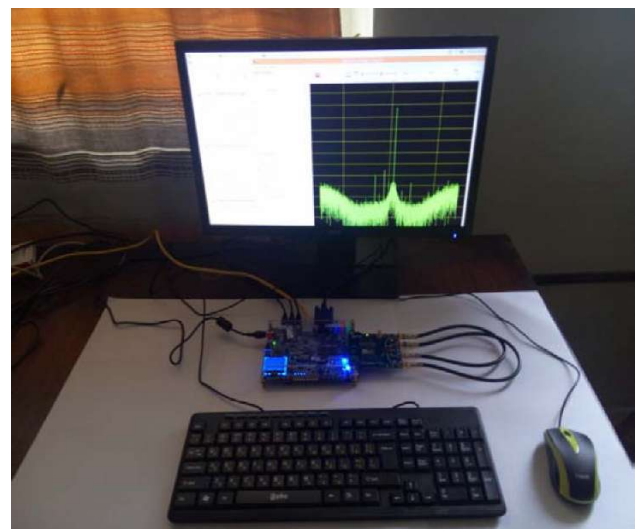

Debugging module for modem equipment

Department of Intellectual Property and Commercialization of R&D Products

37, Peremohy Ave., Kyiv, Ukraine, 03056

e-mail: komerc.patent@kpi.ua, <http://www.kpi.ua>, tel./fax: +38(044) 236-40-56



FREQUENCY FILTRATION DEVICES BASED ON CRYSTAL-LIKE STRUCTURES

Purpose of invention and sphere of application

Theoretical fundamentals of apodized crystal-like structures (CS) have been developed. They include general analysis models and methods of CS apodization for the complex CS analysis and the design of various new high-performance CS-based signal processing devices for information and telecommunication systems. One of these devices is miniature microstrip microwave band filter based on electromagnetic crystals (EC) and certain EC inhomogeneities

Performance-based characteristics

Medium frequency: 1-10 GHz.
Relative passband: 2.60%.
Suppression in the suppression bands: from -20 to -60 dB.
Insertion losses: from 1.5 to 2.5 dB

Intellectual property protection status

The developed constructive solutions of EC and EC-based devices are protected with 9 patents of Ukraine for an invention and utility model

Key benefits of invention

The impedance approach to wave structures modeling, developed by authors, essentially simplifies the modeling and allows to gain completely new scientific knowledge related to the properties of complex wave structures, analysis and synthesis of such structures. The application of these physics and mathematics fundamentals for EC based on technical solutions of high-performance EC, which were suggested by the authors, allows for design of high-selective signal processing devices with suppression improvement by 10-20 dB and signal size reduction by 2-3 times compared to equivalents

Market demand

The invention is intended for radio- electronic industry and guarantees improvement of information and telecommunication system parameters

Standby status

Standby status of the invention – laboratory sample, design documentation

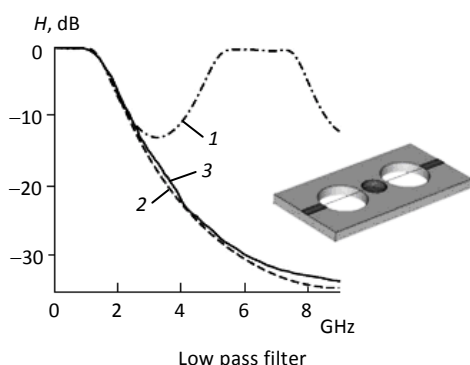

The frequency response: 1 – estimated for the filter of conventional structure; 2,3 – estimated and experimental of the filter based on electromagnetic inhomogeneities (on inset)

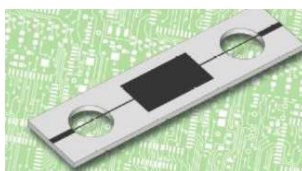

Narrow-band filter

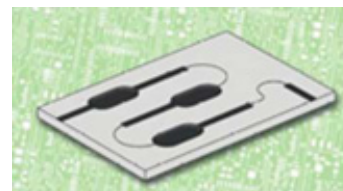

Bandpass filter

Department of Intellectual Property and Commercialization of R&D Products

37, Peremohy Ave., Kyiv, Ukraine, 03056
e-mail: komerc.patent@kpi.ua, <http://www.kpi.ua>, tel./fax: +38(044) 236-40-56



BROADBAND ANTENNA FOR MOBILE COMMUNICATION MEANS

Purpose of invention and sphere of application

The broadband, compact, high-performance antenna for signal reception and transmission in local mobile networks at shared resources. The antenna is universally applicable and services all ranges of mobile communication. It is designed for radio repeaters and radio extenders of mobile communication

Essence of invention

Bandwidth: 700-2500 GHz.
 Voltage standing wave ratio: up to 2.0.
 Range gain coefficient: +5 dBi@700 MHz;
 +7 dBi@2500 MHz.
 Input impedance: 50 Ω .
 Maximum radiant power: 100 W.
 Overall dimensions: 50×50×50 mm (antenna),
 diameter 200 mm (counterpoise)

Key benefits of invention

It exceeds domestic and world equivalents by electrical parameters and dimensions

Intellectual property protection status

1 patent of Ukraine has been obtained

Market demand

The technology is in demand in Ukrainian market and in other countries

Standby status

Designed experimental sample has undergone testing



The appearance of the broadband antenna for mobile communication means

Innovation Centre

6, Svobody sq., Kharkiv, Ukraine, 61022.

e-mail: innovation@karazin.ua, <http://innovation.karazin.ua>, tel./fax: +38(057) 705-52-89



HECTOMETRIC BAND ANTENNA

Purpose of invention

The antenna is intended for signal transmission and reception on the railway between the vehicle and the dispatcher. The antenna has an automatic tuning unit to adjust electrical characteristics of the antenna in case of changes in operating frequency and operating conditions

Key benefits of invention

It exceeds domestic and foreign equivalents by electrical parameters and dimensions

Intellectual property protection status

1 patent of Ukraine has been obtained

Essence of invention

Band of operating frequencies: 2.13-2.15 MHz.
 Standing wave ratio in the operating frequency range: up to 1.5.
 Gain: +1 dBi.
 Input impedance: 50 Ω.
 Maximum radiant power: 20 W.
 Overall dimensions: 4000×200 mm

Market demand

The technology is in demand on Ukrainian, Russian and Belarusian markets

Standby status

Designed experimental sample has undergone testing

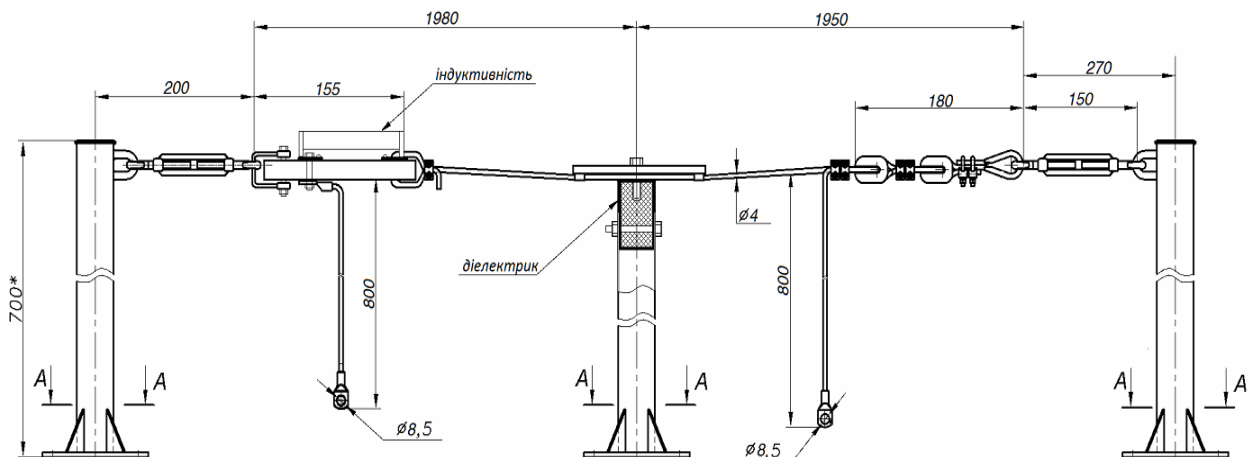

Scheme and dimensions of the hectometric band antenna

Innovation Centre

6, Svobody sq., Kharkiv, Ukraine, 61022.
 e-mail: innovation@karazin.ua, <http://innovation.karazin.ua>, tel./fax: +38(057) 705-52-89



WIRELESS SENSOR NETWORKS WITH SELF-ORGANIZATION FOR ENVIRONMENTAL ATTRIBUTES MONITORING

Purpose of invention

The invention is intended for information and telecommunication support of search and rescue operations in an emergency zone

Essence of invention

- Mathematical model of smart routing system in wireless sensor networks with self-organization (WSN with SO).
- Energy-efficient data aggregation in WSN with SO.
- Sensing routing in WSN with SO.
- Methodology of topology control of WSN with SO.
- Methodology of aerial platform topology control of WSN with SO.
- Semi-scale model of WSN with SO

Key benefits of invention

The application of suggested WSN design methods essentially increases operation agility of the State emergency service units in search and rescue operations and substantially decreases organization expenses

Standby status

The research has been completed. Hardware and software parts of transmission and reception equipment and of computer-assisted data processing and storage system have been developed and tested

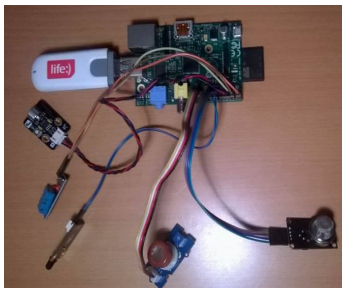

The model of WSN node for the remote sensor-assisted temperature and humidity monitoring

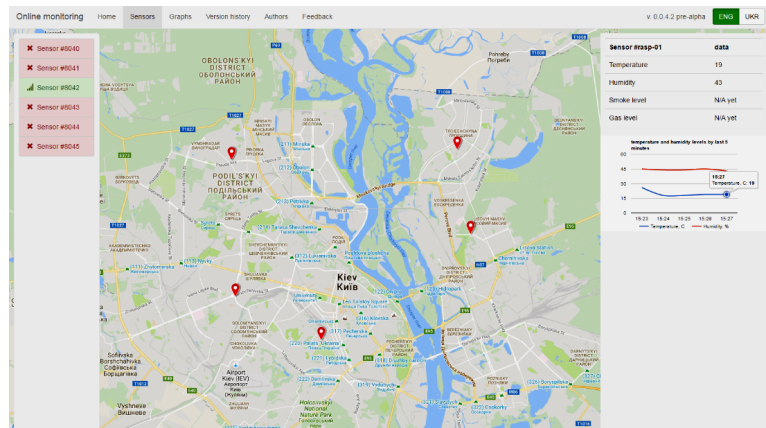

Web interface of client application that is used by an operator during monitoring of environmental attributes



DECOMPOSITION METHOD FOR DETERMINATION OF LAYERED MEDIA STRUCTURE AND EFFICIENT RADAR CROSS-SECTION OF OBJECTS

Purpose of invention and sphere of application

The purpose of the invention is to increase the resolution and reliability of the modern systems of monitoring the current state of industrial constructions to optimize maintenance costs and extend their service life due to new developed principles of the identification and processing of pulse ultra-broadband signals reflected from planar layered media and subsurface objects

Essence of invention

The algorithms of practical application of the decomposition method for quality evaluation of radar masking of special-purpose equipment objects according to the measurement data in the near field are suggested. It is shown that the usage of masking facilities is the most efficient when radiation-absorbing material covers only zones of the highest reflection coefficient rather than the whole object. The impact of layers of construction and underlying soils on the characteristics of secondary scattering of objects is considered



Key benefits of invention

The proposed algorithms and methods of data processing of non-destructive testing and remote sensing with the help of pulse ultra-broadband GPRs and multichannel radiometers do not have any domestic and foreign equivalents

Market demand

The technology is in demand in Ukrainian, Russian, Belarusian and EU markets

Intellectual property protection status

3 patents of Ukraine for utility model and 2 patents for invention have been obtained

Standby status

The results have been implemented in regulatory documents of the State Road Administration of Ukraine (UKRAVTODOR).

R&D Department

6, Svobody square, Kharkiv, Ukraine, 61022.

e-mail: innovation@karazin.ua, <http://innovation.karazin.ua>, tel./fax: +38(057) 705-52-89



INTELLIGENCE RECEIVING SYSTEM

Purpose of invention

The system is designed to search and identify radiation sources parameters. The key tasks of the project are the development of software for control of radio signal use in a specific frequency band; detection of incidental emitters; determination of the observed range load; determination of the field strength at the reception point from different emitters; determination of parameters of emitters and coordinates of radiation sources; identification of the type of emitters

Essence of invention

The software is expected to provide search band of 100 kHz – 10 GHz; sensitivity of receiving set of 1-4 μ V; dynamic range of 100 dB; range of intelligence up to 100 km; information release on CMA of "Oreanda" type; determination of radiation sources: surveillance radar stations and guidance and tracking stations; radio beacons and landing means, airport means of communication; GSM, GPRS and CDMA communication; tropospheric and satellite communication; FM and AM radio stations; citizen band radio communications; television etc.

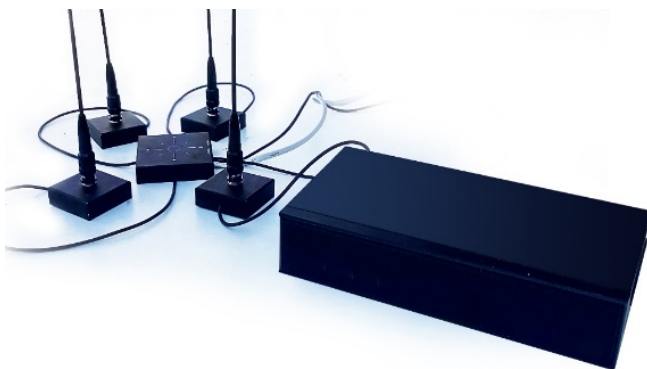

Design of the invention

Key benefits of invention

Low weight-size parameters (portable device), backpack or case variant, low power demand, domestic production and software, fast and accurate radio signal analysis

Intellectual property protection status

1 patent of Ukraine has been obtained

Market demand

The main users of the project are military intelligence, agencies of radio control and radio monitoring of the use of aether space, the development of SDR-receivers and cognitive radio

Standby status

Software tools for the frequency determination of narrowband and broadband radio signals are developed



Department of Scientific and Technical Information

1, Kosmonavta Komarova Ave., Kyiv, Ukraine, 03058

e-mail: vtnik@nau.edu.ua, <http://nau.edu.ua>, tel.: +380(044) 406-71-56, fax: +38(044) 406-79-21



HARDWARE AND SOFTWARE SYSTEM FOR NON-DESTRUCTIVE DETECTION AND RECOGNITION OF UNDERGROUND OBJECTS

Purpose of invention

The remote sounding system for subsurface application with reliable detection and recognition of underground objects is proposed. It functions on the principles of ultra-broadband radiolocation and provides high resolution and sufficient operating range

Essence of invention

Description of invention characterizes the usage of such technologies as: new technology for signal processing of subsurface sounding; automated and improved fields and images processing technology and interpretation of sensing results; advanced technology for generation and emission of sounding ultra-broadband signal to increase the resolution and sounding depth; new technique of stable signal-to-interference ratio in case of the sensitivity enhancement. The invention provides analysis of object condition at a depth of 15-20 m with the resolution at a maximum range of approximately 1 m, and at short distances – at range of a few centimeters

Intellectual property protection status

2 patents of Ukraine for inventions have been obtained

Market demand

Building contractors take interest in the invention to implement it in construction and repair works to determine the state of soil before laying the foundation, to study building sites before and after drilling or pile driving, to investigate landslide hazards etc. It will be useful for municipal infrastructure to detect pipes, connections, collectors, archaeological objects and graves. The military application is also possible

Standby status

The GPR prototype with greater operating depths range compared to well-known samples is constructed. The technique of practical usage of GPR and recommendations on interpretation of results are prepared. The technical documentation and methodological recommendations on remote sounding data interpretation have been developed. The results have been tested and verified

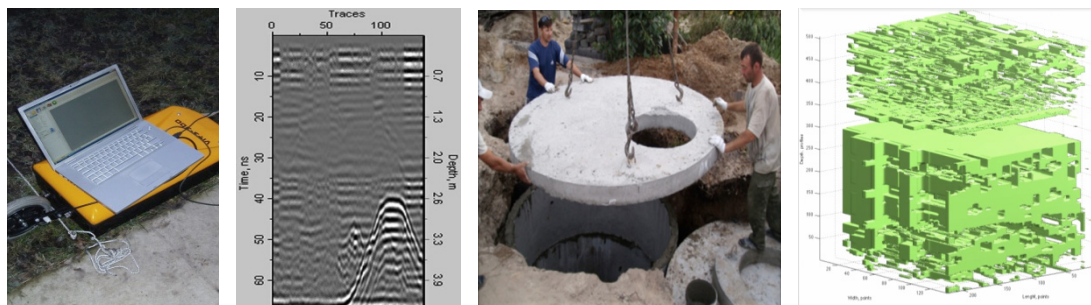

Hardware and software system; an example of two-dimensional scan profile; the studied object; its three-dimensional reconstruction

Department of Scientific and Technical Information

1, Kosmonavta Komarova Ave., Kyiv, Ukraine, 03058

e-mail: vtник@nau.edu.ua, http://nau.edu.ua, tel.: +380(044) 406-71-56, fax: +38(044) 406-79-21



NOISE-IMMUNE RADIO CHANNELS FOR INFORMATION TRANSMISSION

Purpose of invention

The essence of the project is the analysis of the state of noise immunity and information security in modern telecommunication systems (TS), including critical purpose, substantiation of requirements and directions of TS development to increase noise immunity of signal reception, providing information security based on improvement of methodological foundations of system construction by synthesis and processing of new classes of discrete-time complex signals with necessary ensemble, correlation and structural properties, development of means for the formation and processing of signal-code structures and pseudorandom codes

Essence of invention

Description of invention includes new protocols of information exchange and methods of construction and processing of signal-code structures and pseudorandom codes used in telecommunication systems and networks; information exchange management to ensure noise-immune data processing in TS, power and frequency efficiency of information transmission and information security systems of the state. The implementation of development results makes it possible to harmonize the requirements for information security and noise immunity of information transmission and processing systems

Intellectual property protection status

A number of patents of Ukraine have been obtained

Standby status

New mathematical and technical methods of construction and processing of signal-code structures for telecommunication protocols of channel and physical levels, scale models of limited-purpose devices and special software are developed

Market demand

The technology is in demand in Ukrainian market and other countries

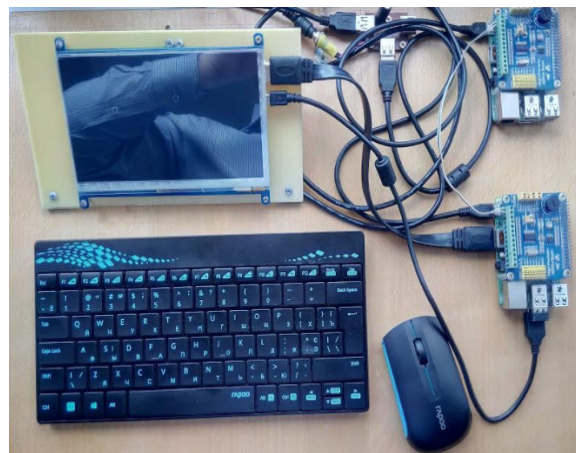

Innovation Centre

6, Svobody sq., Kharkiv, Ukraine, 61022.

e-mail: innovation@karazin.ua, <http://innovation.karazin.ua>, tel./fax: +38(057) 705-52-89



INFORMATION SECURITY DEVICES ON DIGITAL STORAGES

Purpose of invention

Hard disk drives (HDD), USB-flash drives, SSD-storages, optical disks, SD flash cards, CF flash cards are used as digital storage devices. The decision on the information destruction is made either by the operator or by the automatic equipment that should provide high speed, reliability, security and autonomy

Essence of invention

There is a set of technical solutions suggested for protection the information placed on a digital recorder by means of its deactivation when unauthorized access is detected. The key element of devices is the linear electromechanical induction dynamic device of shock action, which by means of a pulsed magnetic field and the mechanical breakdown of digital recording drive prevents information removal in case of unauthorized access. The induction dynamic device includes mechanical-power and electronic units and it is compact and autonomous

Key benefits of invention

The economic attractiveness of the invention lies in the preservation of the most valuable information. The invention can be useful for ministries, departments, businesses and organizations that are working with important information

Intellectual property protection status

13 patents of Ukraine and 11 international patents on inventions have been obtained

Standby status

The exploratory prototype of the device, which provides information security on HDD, has been designed. The principle diagrams have been worked out, main parameters have been experimentally confirmed

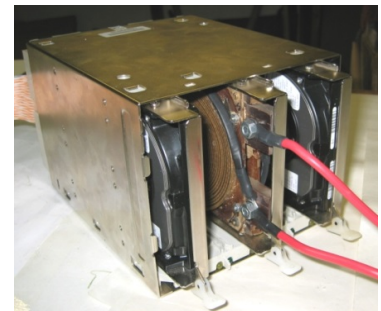

R&D Department

2, Kyrpychova Str., Kharkiv, Ukraine, 61002

e-mail: nti@kpi.kharkov.ua, <http://www.kpi.kharkov.ua>, Tel./fax: +38(057) 707-62-13



TURBO DECODING IN INFORMATION AND COMMUNICATIONS SYSTEMS

Purpose of invention

The purpose of software package is to provide the necessary credibility of data transmission at a certain signal-to-noise level in data exchange channels, estimate probabilistic and energetic characteristics by means of various turbo-decoding methods

Essence of invention

The software package allows for obtaining multimedia data, time quantity and data transmission rate in bps, graphical experimental curves of bit error ratio. A user interacts with the program in the dialog mode. Minimum computer system requirements: Windows 7; a keyboard, a computer mouse; CPU clock speed – 4 GHz, RAM – 8 GB, video – 2 GB, hard drive – 50 GB and higher

Key benefits of invention

Turbo-decoding computational complexity is decreased 3-7 times comparing to MAP method with an insignificant loss of data decoding efficiency (for MAP correlation is $r = 0.9997$, for log-MAP – $r = 0.9998$). Analytic expressions are obtained, which define the number of elementary mathematical operations that should be performed to decode one binary symbol on a digital signal processor. Comparing to equivalents, the program allows for performing a flexible setup of codec parameters, evaluating the credibility of data transmission at a certain signal-to-noise level

Market demand

The complex allows for turbo-codec use in data transmission systems, which are significantly influenced by different kinds of interferences, that are important for wireless communications (satellite and mobile communication), programmed radio systems, which function under jamming conditions

Intellectual property protection status

11 certificates of Ukraine on the registration of the author's right for the product have been obtained

Standby status

The software has been developed and tested

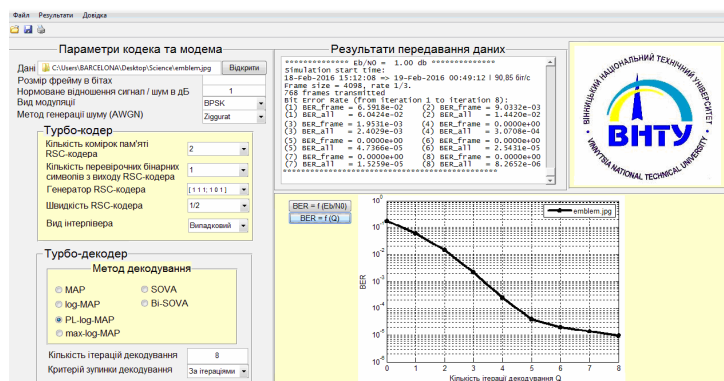

The software interface

Department of Intellectual Property

95, Khmelnytske Shose str., Vinnytsia, Ukraine, 21021

e-mail: vntu@vntu.edu.ua, <http://vntu.edu.ua>, tel.: +38(0432) 56-08-48, fax: +38(0432) 46-57-72



LASER VECTOR SYSTEM FOR IMAGE INPUT-OUTPUT

Purpose of innovation and sphere of application

The development of illuminated advertising and display of graphical information by means of laser technologies and new information display systems with high levels of brightness, directionality and efficiency. Such systems are used in interior design, art projects, technical light support of mass events in modern buildings

Key benefits of invention

The cost of the invention is 3–4 times lower than of equivalents. There is a possibility to input images of laser-scanned objects through reverse channel. The speed is quite high – 40–70 kpps – that corresponds to the level of modern systems. The invention of an optically transparent vacuum chamber became an innovative approach, which allows for a relative increase in angular velocity of the conventional galvanometric deflectors

Intellectual property protection status

1 patent of Ukraine on utility model has been obtained

Essence of invention

Power supply – ~220/12 V, vector scan display rate – 40/60 kpps, angle of display – 8-2 degrees, display mode – colored RGB (638/532/453 nm); interface display mode – dynamic; efficient distance to the screen – 2-15 m. Computer communication interface – RS232/USB 1.1./2.0. Compatibility with vector laser software (Pangoline, LaserCAD, ILDA projection). The total output power of laser sources in RGB mode (638/532/453 nm) > 1000 mW

Market demand

The system is highly competitive in the market of illuminated laser advertisement due to the cost that is 5-6 times lower than the cost of world equivalents

Standby status

An experimental sample is constructed, experimental optical and electronic schemes have been worked out and expected characteristics have been verified

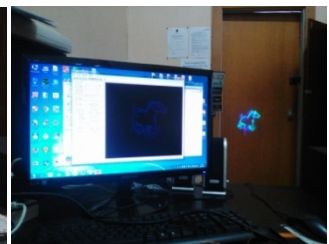
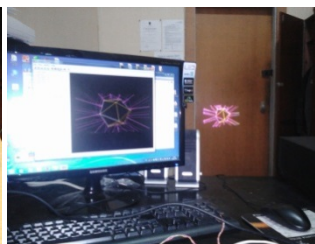

Department of Intellectual Property

95, Khmelnytske Shose str., Vinnytsia, Ukraine, 21021

e-mail: vntu@vntu.edu.ua, <http://vntu.edu.ua>, tel.: +38(0432) 56-08-48, fax: +38(0432) 46-57-72



INFORMATION MICROPROCESSOR-BASED SYSTEM FOR DIAGNOSIS OF MATERIAL MACHINING

Purpose of invention

The information system provides the control of machining quality and technical condition of machine tool in the process of cutting

Essence of invention

The input data for diagnostics is the trend of sound pressure that follows cutting process. The sound pressure is measured using a microphone, which is fixed to the tool holders. In accordance with this data, the actual service life of the machine tool is defined and the values of the state indicators are measured, which allow for quantitative assessment of the detail machining quality and the criticality degree of tool technical condition, reducing them into standard condition indicators

Intellectual property protection status

2 software copyright certificates of Ukraine have been obtained

Key benefits of invention

During the operation the complex provides:

- control of collecting input information required for information analysis;
- rapid processing of registered information;
- quality assessment of machining;
- estimation of the tool service life;
- determination of optimal cutting modes that prevent tool damage and detail defect;
- displaying of diagnostics results on microprocessor screen and their archiving in a form of a text file

Market demand

The invention can be used in mechanical engineering industry

Standby status

The efficiency of automated diagnostic system was tested in both laboratory and manufacturing environments



The example of microprocessor complex usage



Information displayed on the microprocessor screen



R&D Department, Centre of Scientific, Technical and Economic information

2, Rymkoho-Korsakova Str., Sumy, Ukraine, 40007

e-mail: dkurpatov@sumdu.edu.ua, info@cni.sumdu.edu.ua, tel.: +38(0542) 68-78-69, fax: +38(0542) 33-41-08



INFORMATION SYSTEM FOR THE STUDY OF INTERNAL COMBUSTION ENGINE OPERATING PROCESSES

Purpose of invention

The information-measurement system for the research of internal combustion engine (IC engine) operating processes allows to get current parameters of ICE operating cycles and to analyze engine operating process factors

Essence of invention

The developed system allows for measurement of absolute pressure in IC engine cylinder from 0 to 10 MPa at maximum temperature of the cooling measuring sensor membrane up to 350 °C in the range of crankshaft rotational speed from 750 up to 5000 min⁻¹

Key benefits of invention

The information-measurement system allows for obtaining, processing and analysis of IC engine operating process indicator diagrams using an electric pressure converter, an analog-to-digital converter and PC. The system application enables obtaining indicator diagrams of pressure and temperature in cylinder, heat generation and utilization characteristics, determination of duration of combustion period and its phases, combustion hardness, indicated work and power, mechanical losses and engine pumping losses in particular. Similar information-measurement systems of AVL (Austria) and Kistler (Switzerland) are few times more expensive in comparison to the developed one

Intellectual property protection status

2 copyright certificates of Ukraine have been obtained

Market demand

The invention is intended for radio-electronic industry and guarantees parameters improvement of information and telecommunication systems

Standby status

An experimental sample of the system has been designed and used for the research of IC engine operating processes



Technology Transfer, Innovation Activity and Intellectual Property Department

1, M. Omelianovycha-Pavlenka Str., Kyiv, Ukraine, 01010
e-mail: ntt@i.ua, <http://www.ntu.edu.ua>, tel./fax: +38(044) 288-71-01



NATIONAL TECHNICAL UNIVERSITY OF UKRAINE
"IGOR SIKORSKY KYIV POLYTECHNIC INSTITUTE"

SYSTEMS OF OBJECTS MONITORING UNDER DYNAMIC LOADING CONDITIONS

Purpose of invention and sphere of application

The software for evaluation and prognostication of the structural stability of the object under conditions of dynamic loading and under influence of changes of object technical condition has been developed. The obtained results are intended for the use in spheres of safe and effective operation of spatial complex objects

Essence of invention

The monitoring system, algorithmic and software for determination and visualization of parameters of stress-strain state, vibration and spatial position of the object under the influence of dynamic loading have been developed. The methodology is developed and vibration sensors are calibrated, a wireless data transmitter is designed

Intellectual property protection status

The invention is protected with 1 patent of Ukraine and 10 copyright certificates of Ukraine

Market demand

It is reasonable to implement the results in the control of special-purpose engineering constructions, objects of mechanical engineering, power industry, oil and gas transmission industry that will have social and economic significance: environmental preservation, safe operation of essential structures and objects, civil defense

Standby status

The scale model of monitoring system is designed, the structure of system construction and algorithmic and software are developed

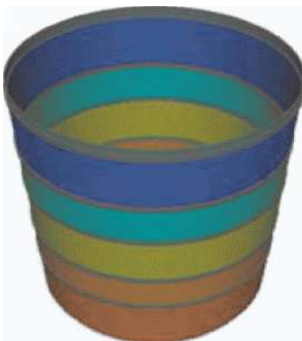

Measured data visualized

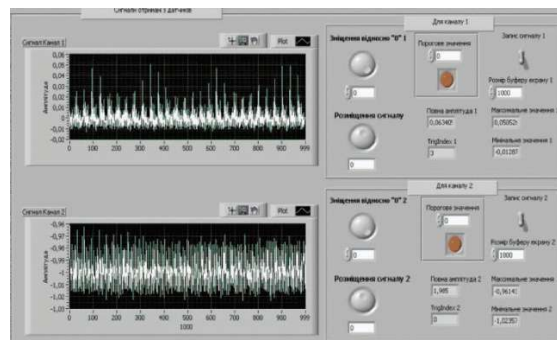

The front panel of the data module



The scale model of the data receiving module

Department of Intellectual Property and Commercialization of R&D Products

37, Peremohy Ave., Kyiv, Ukraine, 03056

e-mail: komerc.patent@kpi.ua, <http://www.kpi.ua>, tel./fax: +38(044) 236-40-56

4. New materials and nanotechnologies

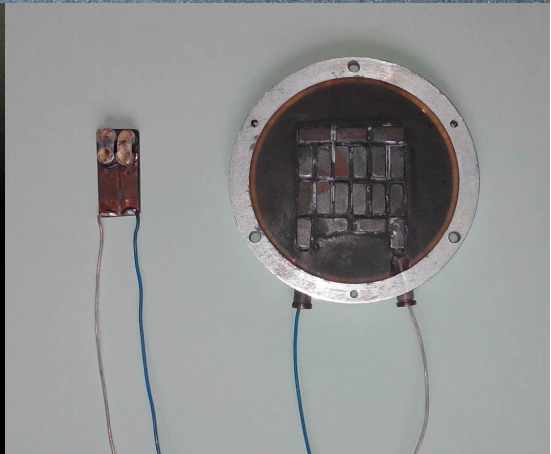



NEW METHOD OF QUANTITATIVE DETERMINATION OF CATIONIC SURFACTANTS IN AQUEOUS SOLUTIONS

Purpose of invention and sphere of application

The method is intended for significant decrease of the determination limit of cationic surfactants in aqueous solutions and for expansion of a range of determined concentrations

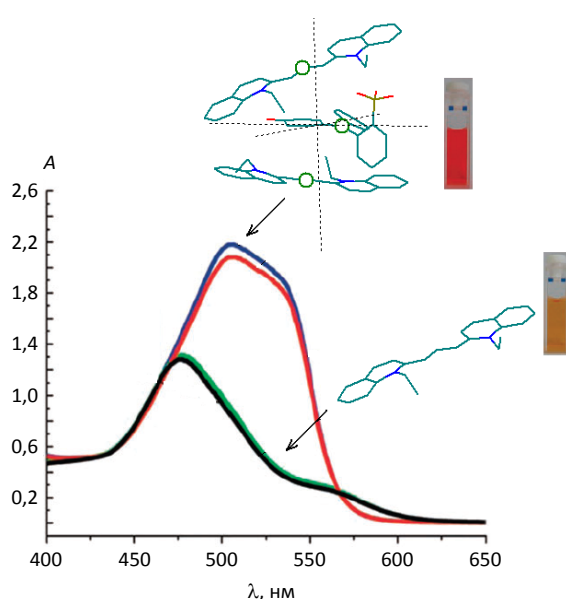

Intellectual property protection status

1 patent of Ukraine has been obtained

Essence of invention

The method is based on change of light-absorbing properties and solution colouring depending on cationic surfactant content of the solution. The determination of cationic surfactant content of aqueous solution is carried out by means of the spectrophotometric method. The method develops ways of quantitative analysis of surfactants in analytical chemistry

Key benefits of invention

Comparing to the best-known methods (for instance, using bromopyrogallol red), approximately 2–5 times lower determination limit of cationic surfactants in aqueous solution is reached and surfactant content range is significantly expanded (10–50 times)

Market demand

The invention is in demand on Ukrainian market

Standby status

A exploratory prototype has been designed

Innovation Centre

6, Svobody sq., Kharkiv, Ukraine, 61022.

e-mail: innovation@karazin.ua, <http://innovation.karazin.ua>, tel./fax: +38(057) 705-52-89



PIEZOELECTRIC AND ACOUSTO-OPTIC ECO-FRIENDLY CRYSTALS

Purpose and sphere of application

The invention deals with growth of active dielectric crystals $\text{NaBi}(\text{MoO}_4)_2$, $\text{BiV}(\text{Nb})\text{O}_4$, LiNbO_3 for needs of modern optoelectronics on an industrial scale

Essence of invention

The piezoelectric and acousto-optic eco-friendly crystals, thin films are proposed. The factors, which influence the efficiency increase of piezoelectric and acousto-optic eco-friendly materials, are defined. The subject of research is defect states, size effects and composition modification of materials near the morphotropic phase boundary, the research and usage of which allow for efficiency increase in piezoelectric and acousto-optic eco-friendly materials

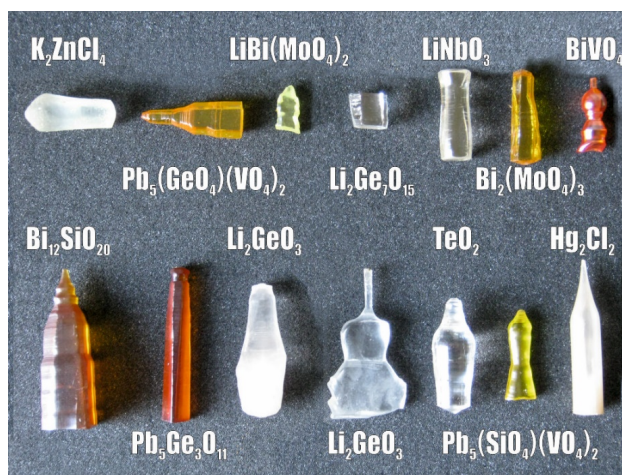

Single crystals of active dielectrics

Key benefits of invention

The invention combines variation of synthesis parameters and comprehensive research that allow for linking physical properties with features of structure, growth environment and material processing

Intellectual property protection status

2 patents of Ukraine have been obtained

Market demand

The demand is caused by the need for the research of new materials and by practical requirements of optoelectronics

Standby status

Laboratory testing – 80%. Industrial testing – 20%. Methods of the increase of crystal optical quality have undergone testing

Department of Scientific and Technical Information

72, Haharina ave., Dnipro, Ukraine, 49010
e-mail: onti_dnu@i.ua, <http://www.dnu.dp.ua>, tel.: +38(056) 760-93-54



HIGH-DISPERSED CALCIUM-CONTAINING HEXAGONAL FERRITE POWDER

Purpose of invention

The invention deals with obtaining biocompatible magnetic component for calcium phosphate-based bioactive composite ceramics (bone implant)

Intellectual property protection status

1 patent of Ukraine has been obtained

Essence of invention

The calcium-containing ferrite powder is proposed for biomedical application for the first time. According to the results of physics and biomedical experiments, it meets the functional requirements for post-operation magnetic hyperthermia of pathologic bone tissue in particular. The way of obtaining calcium-containing hexaferrite nanoparticles doesn't have analogs in Ukraine and abroad

Market demand

The invention is in demand on Ukrainian and Russian markets

Standby status

An exploratory prototype has been designed

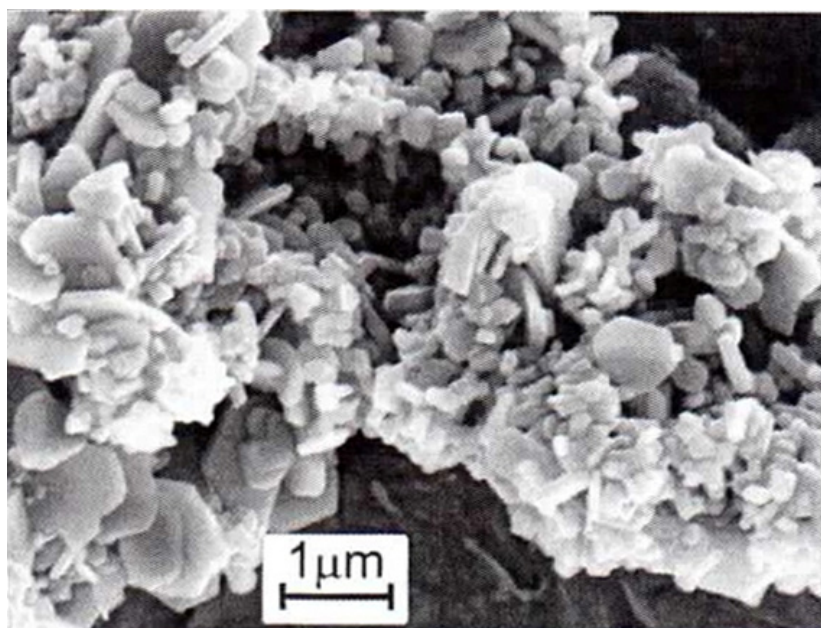

High-dispersed calcium-containing hexagonal ferrite powder

Innovation Centre

6, Svobody sq., Kharkiv, Ukraine, 61022.

e-mail: innovation@karazin.ua, <http://innovation.karazin.ua>, tel./fax: +38(057) 705-52-89



MODIFICATION OF NEW MATERIALS FOR LEAD-FREE SOLDERS BY NANOPARTICLES

Purpose and sphere of application

New nanodispersed materials are designed for lead-free tin-based Sn-Cu-Ag (SAC) solders with metallic and non-metallic nanoparticle admixtures for sequential soldering at different temperature ranges. They can be used in microelectronics, military equipment and household appliances, jewelry and mechanical engineering industry

Intellectual property protection status

1 patent on utility model has been obtained

Essence of invention

The technology of obtaining materials for lead-free solders in the form of 20-30 μm thick stripes by quenching has been improved. The shape of these stripes is convenient for soldering of broad sections with precisely measured size that is important for the connection of metal-matrix composites. The usage of nanoparticles in technology allows for stabilization of solder structure, which experiences significant modifications under external influences (electric and magnetic fields, temperature gradients, cooling rates, vibrations) during crystallization, fatigue cracking and contact creep prevention, graininess decrease and surface wetting improvement

Market demand

According to the EU Directives on abolition of lead soldering, companies of Ukraine as associate member of European Union will implement new soldering technologies based on lead-free solders

Standby status

The methods and technological processes for the implementation of metallic and ceramic nanoparticles in materials for new tin-based lead-free solders have been developed

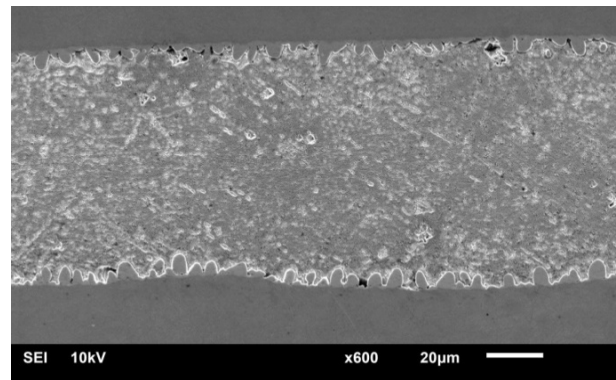
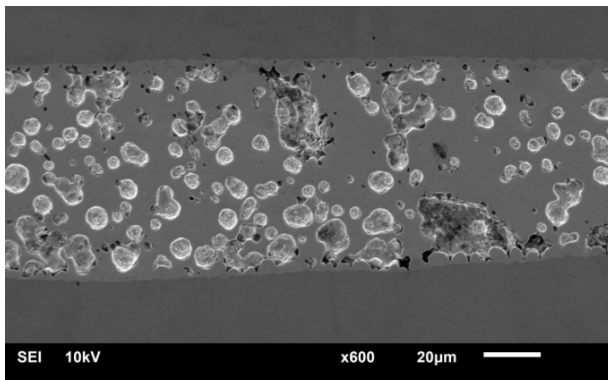

Microstructure of soldered joints in SAC305 alloy with Al_2O_3 nanoparticles

Department of Intellectual Property

1, Universytetska Str., Lviv, Ukraine, 79000
e-mail: a_pryimak@lnu.ua, <http://www.lnu.edu.ua>, tel.: +38(032) 239-43-69



TECHNOLOGY OF OBTAINING COMPLEX FLUX

Purpose of invention and sphere of application

The technology for production of complex flux as a substitute of flux content of sintering mixture has been developed. This technology can be used in sinter plants or mining complexes, which include department of metallurgical raw materials agglomeration



The appearance of complex flux

Essence of invention

The technology of obtaining complex flux combines processes of producing limestone and ferrite compounds during sintering of combined granules in conveyor. Combined granules are obtained by knurling iron-ore material over pre-wetted surface of limestone pieces. To produce complex flux charge, limestone 3-10 mm big, iron-ore magnetite concentrate and solid fuel (coke) 0-5 mm big are used

Key benefits of invention

The manufacturing technology is possible with the flowsheets of agglomerating plants. In this case there is no need for additional equipment. This technology allows for obtaining complex flux of predetermined content and properties. The change from conventional flux to the complex one enables to increase the efficiency of sinter plant by 16.02%, agglomerate strength and decrease fine fraction content by 8.37% and solid fuel losses by 1.5-2%.

Intellectual property protection status

The technology is protected with two patents on utility model

Market demand

The developed technology can be in demand at Ukrainian ironworks.

Standby status

The importance of technology for obtaining complex flux is substantiated, basic operational parameters of complex flux are defined and the recommendations on usage of produced flux in sinter plant have been developed



POLYSTYRENE COMPOSITE SCINTILLATORS

Purpose of invention

The invention deals with nuclear safety through detection of X-ray, gamma quantum and neutron radiation, radiation control, radiation spectrometry etc.

Market demand

The invention is in demand in such fields: monitoring of radioactive pollution; visualization in medicine, control of radioactive materials movement; nuclear safety in industry. The invention can be implemented either in Ukraine or abroad

Key benefits of invention

Composite scintillators based on polymer matrix with embedded nanoparticles have speed of response of ~2 ns and efficiency of low-energy gamma quanta is 5-20 times higher than polystyrene scintillators. Comparing to crystal detectors, its production cost is significantly lower

Standby status

The lab technology of polystyrene-based composite film scintillators with embedded inorganic nanoparticles has been developed

Intellectual property protection status

A patent of Ukraine for invention has been obtained

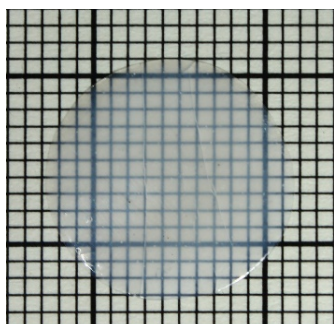

a

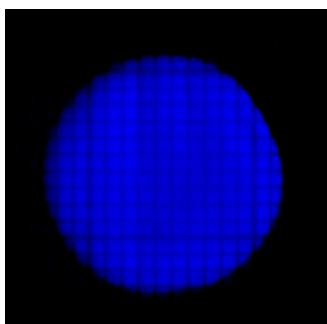

b

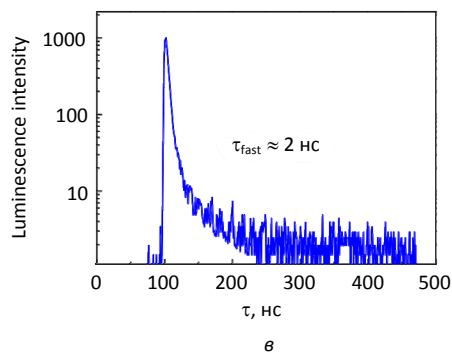

Sample of film composite 0.3 mm thick with BaF₂ nanoparticles (average size of nanoparticles – 20 nm, concentration – 40 wt.%) in visible light (a), under ultraviolet radiation (b) and decay kinetics of its luminescence under X-ray radiation (c)

Department of Intellectual Property

1, Universytetska Str., Lviv, Ukraine, 79000
e-mail: a_pryimak@lnu.ua, <http://www.lnu.edu.ua>, tel.: +38(032) 239-43-69



CONTAINERS AND MATERIALS FOR THE MANAGEMENT OF LOW AND INTERMEDIATE RADIOACTIVE WASTE

Purpose of invention

The invention deals with manufacturing of the containers for transportation and storage and modular facilities for low and intermediate long-term storage of radioactive waste to rehabilitate polluted sites

Essence of invention

Unlike existing technologies of radioactive waste storage, the suggested project is based on brand new materials and technologies of manufacturing storage tanks and transportation of low and intermediate waste. Radiation absorption coefficient of designed materials is 1.4–1.7 times higher than that of steel. According to the results of IAEA-based tests, the estimated service life is 300 years without overload. According to the results of product operation under conditions of solar radiation, high humidity, industrial gas contamination, in the air and marine environment for 30 years, no signs of corrosion and destruction were detected

Key benefits of invention

The benefits of the invention are increased radiation resistance of containers; 10 times increased service life; increased strength; low product mass at an equivalent volume that decreases the damage risk in case of dynamic loadings during transportation and warehousing. There are no equivalents of designed containers and modular facilities in the world market

Market demand

The results can be implemented in nuclear power plants, radioactive waste storages and manufacturing plants

Intellectual property protection status

3 certificates for scientific discovery have been obtained. The invention is protected with patents of Ukraine and other countries

Standby status

Standby status of the invention – 75%. There are samples of containers of different volumes from 0.2 up to 40 m³. There are capacities for manufacture organization



Base container KHS-02K
(0.2 m³)



Variants of modular facilities

Department of Scientific and Technical Information

72, Haharina Ave., Dnipro, Ukraine, 49010
e-mail: ontj_dnu@i.ua, <http://www.dnu.dp.ua>, tel.: +38(056) 760-93-54



NANODISPERSED POWDER MATERIALS FOR THE ELEMENTS OF CERAMIC FUEL CELLS

Purpose of invention

The methods of synthesis and composition of nanodispersed oxide powders are intended for production of such major elements of ceramic fuel cells as solid electrolyte, anode, cathode

Essence of invention

Description of invention is the use of oxides of aqueous solutions of zirconium salts or others for nanodispersed powders production. They establish conditions for the formation of polymeric particles in size of 10–50 nm, which preserve their size throughout all the system transformations due to specific physico-chemical and technological actions: solution–sol–gel–xerogel–oxide. The size of finite particles of zirconium dioxide is 50–100 nm. The production of 1 kg of nanodispersed stabilized zirconium dioxide under the conditions of Ukrainian production costs 25–30 \$/kg. At the same time the world price of such material (for instance, the firm "TOSOH", Japan) is 70–80 \$/kg

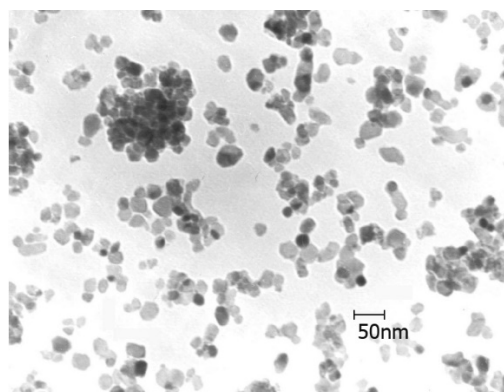

TEM image of nanosized ZrO₂ particles

Market demand

The invention is based on the application of raw-material base of Ukraine. It is commercially attractive and has perspectives for European market promotion as perspective materials and technologies for developers and manufacturers of electric power generators based on ceramic fuel cells. The developed materials and their compositions can be used as effective hydrocarbon conversion catalysts for syngas and hydrogen production

Intellectual property protection status

3 patents of Ukraine have been obtained

Standby status

Standby status – 90 %

Department of R&D Products Commercialization

8, Haharina Ave., Dnipro, Ukraine, 49005

e-mail: udhtu@udhtu.edu.ua, www.udhtu.edu.ua, tel./fax: +38(0562) 47-33-97



CAST POROUS METALS FOR MICROCAPILLARY HEAT PIPES

Purpose of invention

The designed porous metals are intended for production of heat pipes, which have high heat conductivity characteristics.

Key benefits of invention

The application features of wear-resistant composite material guarantee significant increase of the whole complex of mechanic and exploitory properties of fast-cutting instruments and the saving of expensive alloy materials.

The resistance of an instrument made of a new material is increased to 30–40 %, wear-resistance – to 55–65 % in comparison with the best native analogue. After laser treatment, the hardness and wear resistance of the laser-reinforced surface are increased to 1.32–2.06 times, after high-temperature annealing, the strength characteristics of steels increase by 30%, plastic – by 30–40%

Intellectual property protection status

A patent of Ukraine has been obtained

Standby status

The exploratory prototype proved the expected high thermal conductivity characteristics

Essence of invention

Production of the heat pipes of copper cast porous capillary materials to use them as powerful heat sinks in electronics.

Thermal conductivity of capillary materials is influenced not only by heat transfer agent, but also heat capacity of a pipe. The analysis of influence patterns of heat capacity ratio, type of heat transfer agent and pore orientation in copper capillary porous materials on their thermal conductivity showed that it is 200-400 times higher than in monolithic samples

Market demand

The designed porous metal is in great demand in modern electronics. It is used for production of small and powerful heat sinks for power elements. It will allow for significant improvement in their operation conditions and decrease of equipment sizes

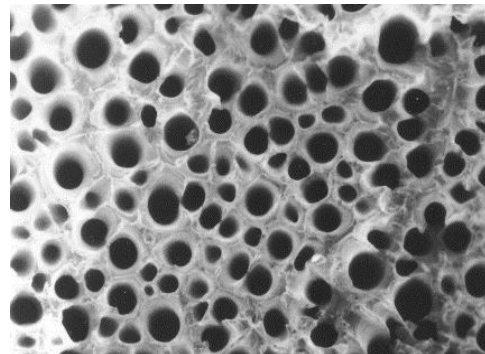

The image of pores in cast porous metal that is used as a heat pipe for effective heat sink

Department of Intellectual Property and Commercialization of R&D Products

4, Haharina Ave., Dnipro, Ukraine, 49600

e-mail: projdak@metal.dmeti.dp.ua, <https://nmetau.edu.ua>, tel./fax: +38(056) 745-41-96



THERMAL GREASE

Purpose of invention

The invention is intended for heat removal from heat-forming elements of electronic devices, especially processors, chipsets, video accelerators of computers etc.

Essence of invention

The use of ZnO nanoparticles instead of ZnO micropowder for thermal grease production leads to the increase of the coefficient of thermal conductivity

Key benefits of invention

The improvement of heat removal from heat-forming elements of electronic devices is gained due to three times higher coefficient of thermal conductivity compared to existing equivalent – KPT-8 grease

Intellectual property protection status

1 patent of Ukraine on utility model has been obtained

Market demand

The invention will be in demand in electrical engineering. It can be used either in Ukraine or abroad

Standby status

The technology of manufacturing has been developed

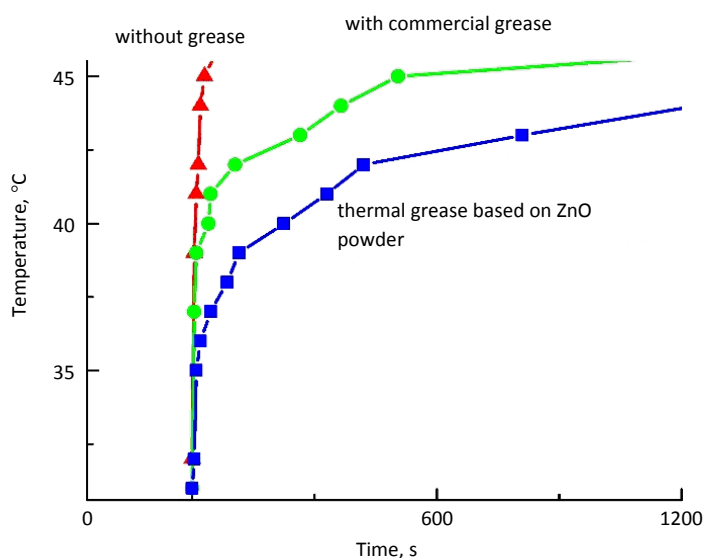

The application of thermal grease in computer technology and graphs of the dependence of operation temperature of the computer processing unit at a steady loading, with copper radiator for heat removal, on the computer operating time

Department of Intellectual Property

1, Universytetska St., Lviv, Ukraine, 79000

e-mail: a_pryimak@lnu.ua, <http://www.lnu.edu.ua>, tel.: +38(032) 239-43-69



NON-COMBUSTIBLE HEAT-INSULATING MATERIALS

Purpose of invention and sphere of application

A number of non-combustible heat-insulating materials are proposed for integrated thermal insulation of vertical surfaces of different shapes and configurations, building structures, facades and interior surfaces of walls; heat-insulating and anti-corrosion protection of pipes (steam pipes) and piping system elements, industrial, boiler and capacitive equipment with temperature of the coolant up to +160 °C, in peak mode up to +190 °C; integrated protection of metallic constructions using heat-resistant and heat-insulating materials with a high coke residue (up to 60% at the temperature 600 °C); heat insulation of objects with increased fire safety requirements

Essence of invention

The materials are water- and alcohol-based liquid compositions, which contain polymeric film-forming agents, polymeric, glass, ceramic or other microspheres, low-density fillers (wood flour, rice hull flour), flame retardants and other processing additives. They are applied to the protected surface with paint spray gun, roller or brush. Thickness of one coating layer is not more than 0.4 mm, drying time of one coating layer is 2–4 h at the room temperature and 24 h when applied every 2 mm of coating layer. Maximum thickness of material: 10–12 mm, density of finished coating: 0.35–0.55 g/cm³; strength at breakage: 0.7–2.0 MPa; relative lengthening 5–15%; coefficient of thermal conductivity: up to 0.1 W/(m·C); specific heat capacity: not less than 1.6 kJ/kg·C; the decrease of heat losses with thickness of 1 mm: up to 250%; adhesion to metal and concrete: 1 point; longevity: 10–20 years



The appearance of the prototype of 11 mm thick non-combustible heat-protective coating

Intellectual property protection status

3 patents of Ukraine have been obtained

Market demand

The invention can be used in residential and industrial construction, and by heat supply companies

Standby status

The proposed heat-insulating materials were industrially tested

Department of Intellectual Property and Commercialization of R&D Products

8, Haharina ave., Dnipro, Ukraine, 49005

e-mail: udhtu@udhtu.edu.ua, www.udhtu.edu.ua, tel./fax: +38(0562) 47-33-97



ELECTRICALLY CONDUCTIVE COMPOSITE MATERIAL

Purpose of invention

The composite material based on polyurethane with 18-molybdodiphosphate is intended for determination of reducing agents, oxidants, redox potential in biomedical and clinical trials, studies of raw materials contamination, environmental objects, in the analysis of pharmaceuticals, agricultural products and food products

Key benefits of invention

18-molybdodiphosphate is a promising redox reagent of multiple uses; its reaction with certain substances occurs almost instantaneously, it is possible to determine several substances in a joint presence. The analytical characteristics of the created electrochemical electrode for determination of the reducing agents have been improved: rapidity, ease of execution, reproducibility, versatility, sensitivity and long service life

Intellectual property protection status

1 patent application on the utility model has been submitted

Essence of invention

The synthesis of polymer composite materials with 18-molybdodiphosphate based on polyurethane and graphite powder as a conducting material was carried out. The developed material includes a reagent-oxidant 18-molybdodiphosphate that interacts directly with an analyte, the detection of reagent concentration change, which provides greater reliability and accuracy of the analysis

Market demand

Composite material and electrochemical electrode may be used in analytical laboratories of chemical, food, pharmaceutical and other industries and in metrological centers as well

Standby status

The best ratio of composites components and their electrical properties have been investigated. An electrochemical electrode based on synthesized composite material has been created

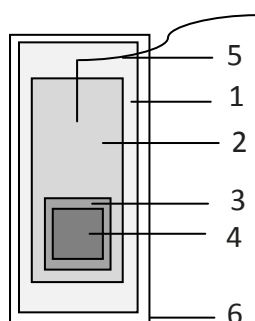

The design scheme of the potentiometric electrode:

- 1 – polypropylene liner; 2 - copper foil;
- 3 – a layer of graphite; 4 – polyurethane composite material;
- 5 – copper wire; 6 – polyurethane protective coating

R&D Department

25, Serhiia Yefremova Str., Dnipro, 49600, Ukraine
e-mail: nauka_ddau@ua.fm, <https://www.dsau.dp.ua>, tel.: +38 (056) 713-51-74



MATERIAL FOR THERMOCOUPLE AND THERMAL ELEMENTS

Purpose of invention and sphere of application

The invention concerns material science especially new intermetallic thermoelectric alloys and may be used while producing such devices as thermoelectric generators for the direct conversion of thermal energy to electric. Thermoelectric generators are widely used in various technological processes due to the large volumes of so-called "excess" (rejected) heat. By virtue of working in the opposite direction, thermoelectric generators may be used as cooling units. Such refrigerators do not require compressors and harmful refrigerants that destroy the ozone layer of the atmosphere

Key features of invention

New thermoelectric materials on the basis of MgAgAs structural type intermetallic semiconductors are offered. These materials provide a power factor of about $30 \mu\text{W} (\text{K}^2 \cdot \text{cm})$ at 300 K and a thermo-emf value of more than $350 \mu\text{V/K}$ at 400 K

Key benefits of invention

The essential benefit of the materials developed is the simple method of synthesis (electric-arc melting) as well as the relatively low price and non-toxicity of the output components. Modifications of the component composition of such semiconductors lead to the improvement of thermoelectric characteristics

Intellectual property protection status

2 patents of Ukraine on utility model have been obtained

Market demand

Fields of demand: engineering industry, auto industry, space industry, instrument engineering industry

Standby status

The procedure of synthesis of materials for relatively small energy expenses was well-proved. There is a possibility to obtain the semiconductors of n- or p-type conductivity as required

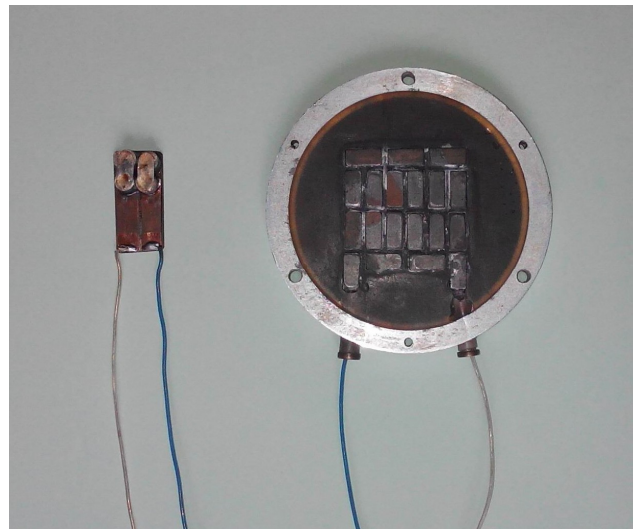

Department of Intellectual Property

1, Universytetska Str., Lviv, Ukraine, 79000
e-mail: a_pryimak@lnu.edu.ua, <http://www.lnu.edu.ua>, tel: +38 (032) 239-43-69



MEDIUM- AND HIGH-TEMPERATURE GREASES FOR HEAVY DUTY SLIDING AND ROLLING FRICTION UNITS

Purpose of invention and sphere of application

Medium-temperature greases are the most effective for bearings in wheel hubs, generators, water pumps, for threaded joints, ball joints of automobiles, in the roll hubs of transfer lines of rolling mills, during operation of machine tools, etc. High-temperature greases are effective for lubricating chain and tooth gears, for example in aluminum tubes annealing furnace, burning bricks, for roller mechanisms lubrication of furnaces doors, for heating metal while its heat treatment, for roll hubs lubrication of transfer lines of rolling mills, threaded joints and bayonet locks for chemical reactors etc

Essence of invention

Medium-temperature greases are designed for heavy duty slow- and high-speed sliding and rolling friction units operating at temperatures up to 250 °C, high-temperature greases – for heavy duty slow-speed sliding friction units operating at temperatures up to 400–450 °C and in short-time operation up to 800 °C

Intellectual property protection status

6 patents of Ukraine have been obtained

Key benefits of invention

The antiwear properties of medium-temperature greases compared to "Litol-24" grease are 9–13 times higher, which increases the service life of friction couples in several times. At the same time, the antiwear properties of these greases grow with the increase of the specific load, which is observed for the first time and is realized at the expense of special sulfur organophosphorus additive. In comparison with foreign analogues, high-temperature greases are more effective when operating at higher temperatures; the duration of greasing in a single application as well as anti-wear properties are higher in 2–2.5 times. Greases are capable of withstanding the effects of aggressive environments and they are not water-washable which reduces environmental pollution

Market demand

Greases may be used for vehicles, in mechanical engineering, in rolling mills and machine tools operation, in bakery industry, in glass and glassware production

Standby status

Medium- and high-temperature greases have undergone industrial tests, and their experimental parties have been implemented in many enterprises in Ukraine and CIS countries

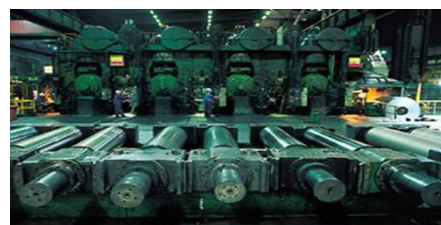

Industrial greases tests

Department of Intellectual Property

72, Akademichna Str., Kramatorsk, 84313, Ukraine

e-mail: nis@dgma.donetsk.ua, <http://www.dgma.donetsk.ua>, tel: +38(0626) 41-67-88, fax: +38(0626) 41-63-15



OBTAINING WEAR-RESISTANT COMPOSITE MATERIAL AND MICROCOMPOSITE STEELS

Purpose of invention

The materials and steels developed are intended for use in the manufacture of a high-speed cutting tool and parts of machines and mechanisms

Intellectual property protection status

2 patents of Ukraine have been obtained and 1 application for the patent of Ukraine has been submitted

Essence of invention

A wear-resistant composite material based on the Fe-W-Cr and Fe-Mo-Cr alloys is obtained by forming a "carbide inclusion-matrix" composite structure in the surface layer. Microcomposite alloy is produced using new physical principles of structuring. Component parts are made by thermochemical treatment using standard operating equipment

Performance characteristics indicators of the tool made from the composite material

Wear-resistant material	Hardness, HRC	Tool durability, min	Wear per 35 min, mm
Based on Fe-W-Cr	61	132	0,22
Based on Fe-Mo-Cr	62	144	0,18

Key benefits of invention

The performance characteristics of wear-resistant composite material guarantee a significant increase in the complex of mechanical and performance characteristics of the high-speed cutting tool and the saving of expensive alloying agents. Durability of the tool made of a new wear-resistant material increases by 30–40%, wear resistance – by 55–65% compared to the best domestic analogue. After laser processing the hardness and wear resistance of the laser-reinforced surface are increased by 1.32–2.06 times; after high-temperature annealing the strength characteristics of steels are increased by 30%, the plastic characteristics – by 30–40%

Standby status

The experimental prototypes have been created; the anticipated characteristics have been verified

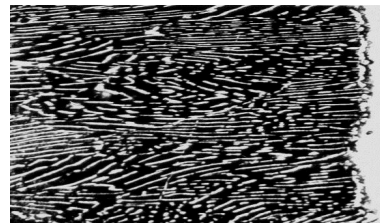

a

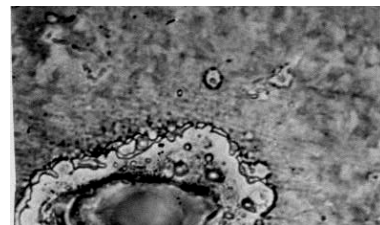

b

Wear-resistant composite material based on Fe-W-Cr and Fe-Mo-Cr alloys (a) and microcomposite steel structure after laser processing (b)

Market demand

Machine factories and metallurgical plants of Ukraine, railway depots need high-quality tools for various purposes and high-strength as well as wear-resistant steels for machine and mechanisms components

Department of Intellectual Property and Commercialization of R&D Products

4, Haharina Ave., Dnipro, Ukraine, 49600

e-mail: projdak@metal.dmeti.dp.ua, <https://nmetau.edu.ua>, tel./fax: +38(056) 745-41-96



COMPOSITE MATERIALS BASED ON POLYMERS FOR HEAVY LOADED, HEAT-STRESSED METAL-POLYMER FRICTION UNITS

Purpose of invention

The obtained composite materials provide reliable hermetic sealing of sliding and fixed joints, have high resistance to destruction under the influence of aggressive environments and wear resistance when operating tribosystems without lubricant or with its restriction

Key benefits of invention

The durability of the sealing arrangements made of the "flubon" exceeds that of such Russian manufacturers' materials as ftorlone-4, F4K20, AFGM by 3–10 times and such foreign manufacturers' materials as "Garlock", "Merkel", "Dixon", "VEF Viurzen", "Niunkhrytts", "Ynelard" by 3-5 times

Intellectual property protection status

Three author's certificates of the USSR and three patents of Ukraine have been obtained

Market demand

Potential users are the chemical industry enterprises, chemical engineering, compressor industry, food manufacturing industry and agricultural sector

Essence of invention

The developed series of materials under the trademark "Flubon" is distinguished with high wear and chemical resistance, low friction coefficient, self-lubricating and sealing properties. Details made of the "flubon" material (friction bearings, bearing cages, shoulder bearings) are used in friction units of technological equipment of various applications. At the same time high durability and performance reliability of equipment, lubricants saving, metal consumption reduction, machine repair and maintenance costs reduction, as well as catalysts regeneration in chemical industry are achieved. The "flubon" has a critical nominal pressure from 3 to 10 MPa, sliding velocity up to 4 m/s, operational temperatures from 23 to 533 K (in short-time operation up to 593 K). At extreme temperatures, the material retains high mechanical properties, which vary in composition and technology

Standby status

The manufacturing technology of the "flubon" has been developed, technical documentation for its production has been developed as well; and the invention is ready for implementation



Ring seals made of the composite material "flubon" for a 4-stage compressor

R&D Department

11, Instytutaska Str., Khmelnytskyi, 29016, Ukraine

e-mail: centr@khnu.km.ua, <http://www.khnu.km.ua/root/page.aspx>, tel.: (0382) 72-55-88, fax: (03822) 67-42-65



INNOVATIVE TECHNOLOGIES OF HIGH-EFFICIENT FUNCTIONAL COATINGS

Purpose of invention

The invention concerns the new coating formation technologies with multicomponent galvanic alloys, monometallic and complex oxides and metal-based composite materials, strengthened by nanosized oxides

Intellectual property protection status

65 patents of Ukraine have been obtained

Essence of invention

Light metals (aluminum, titanium, magnesium) coating has extremely high adhesion, high temperature resistance and chemical resistance to the aggressive environment effects. Coprecipitated oxides of transition metals (manganese, cobalt, etc.) provide high catalytic properties in oxidation-reduction reactions, and coating with multicomponent alloys, composites and nanolaminates significantly outperforms the original components. The coatings on light alloys have wear resistance at the level of hard alloys, microhardness – up to 2500 kg/mm², porosity – from 2 to 50%, breakdown voltage – up to 6000 V, corrosion resistance – mark 1 (the highest) and the ability to withstand temperature shock up to 2500°C while multicomponent alloys have the corrosion resistance and microhardness higher than with hard chromium coating

Market demand

High-performance environmentally safe technological processes of coating with synergetic alloys, oxides, composites and nanolaminates are in demand for the mechanical engineering, chemical industry, municipal engineering, automotive industry, nanoelectronics, electrochemical power industry and environmental protection technology

Standby status

Technological regulations for all technological processes were processed, tests of functional properties of coatings, materials and products were undergone, the positive reviews were received

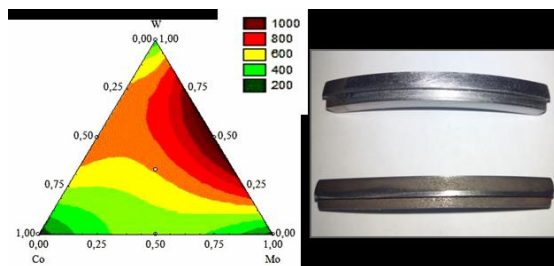

Microhardness (MN / m²) of Co-Mo-W coating for surface reconditioning

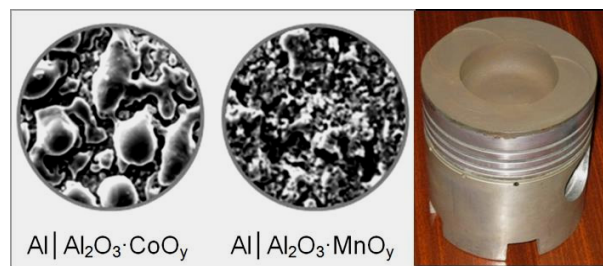

Catalytic oxide coatings of engine piston

R&D Department

2, Kyrpychova Str., Kharkiv, 61002, Ukraine
e-mail: nti@kpi.kharkov.ua, <http://www.kpi.kharkov.ua>, tel /fax: +38(057) 707-62-13



MULTILAYER FUNCTIONAL COATINGS

Purpose and sphere of application

The invention is intended to increase the corrosion resistance and improve the mechanical properties of the metal ware surface as well as to provide the catalytic properties to the anodes surfaces in the oxidation reactions of organic substances, such as methanol, for the functioning of combustion cells. Fields of application: mechanical engineering, automotive, shipbuilding industries and alternative energetics

Essence of invention

Multilayer coatings consist of layers of various nickel-copper alloys up to 100 nm in thickness each. All alternating coat layers are electrochemically deposited from one galvanic tank. The coating, containing 50-80% nickel and having a microhardness of 410-680 HV, is ductile, well adherent to an electronegative and corrosion-unstable base, such as, for example, the surface of neodymium magnets. A multilayer coating consisting of nickel-copper alloy layers and metals mixtures as well as their hydroxides has an increased by 1.5 to 2 times catalytic activity in the reactions of electro oxidation and the stability of the properties of the surface compared to single-layer coating

Intellectual property protection status

2 patents of Ukraine on invention have been obtained

Key benefits of invention

Compared to the world's analogues, it is possible to obtain thicker compact multilayer coatings in industrial conditions due to the use of polyligand electrolyte combining with the proposed electrolysis mode and surface preparation conditions. The economic expediency of using multi-layer coatings is determined by materials saving due to the increased service life of products and reduced manufacturing costs

Market demand

There is a market need to replace the coating with chromium and nickel in cases where it is necessary to use more rigid and at the same time non-brittle coatings, as well as to reduce the prime cost of coating and increase the environmental safety of production. Catalytic coating is necessary in the oxidation processes of organic substances including fuel methanol elements as well

Standby status

The laboratory tests proved the competitive ability of multilayer coatings and the possibility of their production in industrial conditions

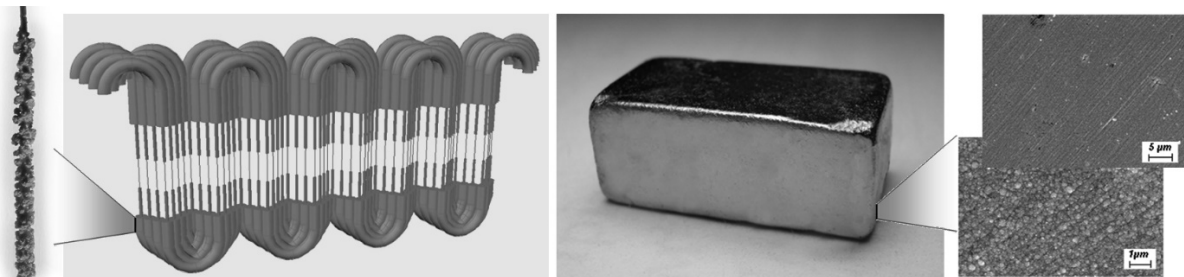

Electrode with catalytically active multilayer coating and neodymium magnet with protective multilayer coating

R&D Department

2, Kyrpychova Str., Kharkiv, 61002, Ukraine
e-mail: nti@kpi.kharkov.ua, <http://www.kpi.kharkov.ua>, tel /fax: +38(057) 707-62-13



HIGH-CARBON WEAR-RESISTANT COATINGS OVERLAYING BY USING CARBON FIBER MATERIALS

Purpose of invention

The technology of overlaying is based on the use of carbon fiber materials and allows obtaining wear-resistant high-carbon coatings with high tribotechnical properties on the steel components

Essence of invention

Obtained by overlaying using carbon fiber materials, the coatings can be of different thicknesses, have a hardness of HRC 54–60 without additional heat treatment after overlaying and may also work under different friction conditions. During overlaying the use of carbon fiber coatings allows increase of the wear resistance of the component within 20% range in reference to new components

Intellectual property protection status

6 patents of Ukraine have been obtained

Market demand

The proposed technology allows increasing significantly the service life of the components and simplify the process of functional coatings application. Therefore, it will be widely used in various industries as well as in the machine components manufacture and repair

Standby status

The manufactured samples passed the operational tests, during which the expected indicators of wear resistance were confirmed

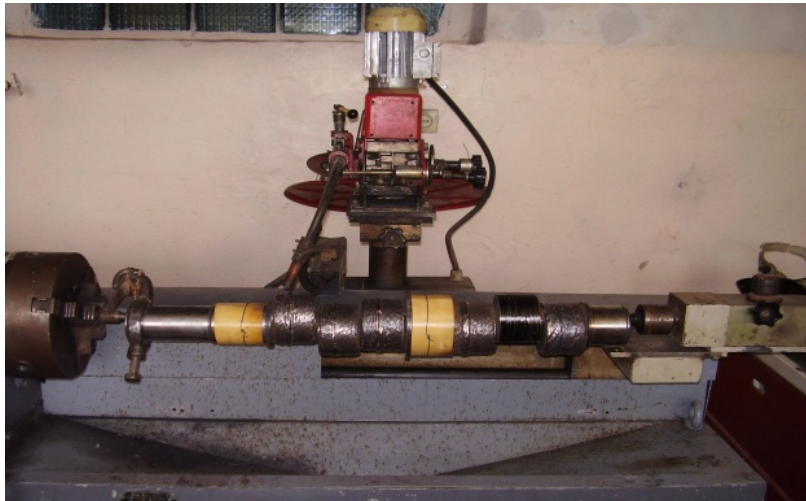

Department of Intellectual Property

95, Khmelnytske Shose Str., Vinnytsia, 21021, Ukraine

e-mail: vntu@vntu.edu.ua, <http://vntu.edu.ua/>, tel: +38(0432) 56-08-48, fax: +38(0432) 46-57-72



BULK AND RIBBON AMORPHOUS IRON-BASED ALLOYS DOPED WITH *d*-BLOCK ELEMENTS

Purpose of invention and sphere of application

Integrated studies of the physicochemical properties of amorphous and nanocrystalline materials contribute to the expansion of their fields of usage: the creation of amorphous metal alloys with increased catalytic activity for the full oxidation processes of harmful industrial emissions and the catalytic hydrogen release; creation of magnetic sensors and magnetic medicine carrier; new products manufacturing for the needs of the domestic agrarian sector of the economy, in particular the formation of protective corrosion- and wear-resistant coatings on the tools of tillage machinery

Essence of invention

Electrochemically formed protective oxide-hydroxide layers on the striped and bulk amorphous alloys increase corrosion resistance in aggressive environments of different electrolytic composition, and the electrodes themselves exhibit high electrocatalytic ability in the reactions of hydrogen release from alkaline solutions

Key benefits of invention

Modified arrangement of ribbon and amorphous alloys samples increased their microhardness compared to crystalline iron by 10–15 times, electrical resistance by 2 times, corrosion resistance in aggressive environments by 3–5 times. The use of modified electrodes from such materials increased the efficiency of hydrogen evolution by 2–3 times

Intellectual property protection status

4 patents of Ukraine on the utility model have been obtained

Market demand

Fields of demand: instrumentation manufacturing, mechanical engineering, electrical engineering, chemical and medical industries

Standby status

Ribbon and bulk samples of amorphous metal alloys doped with *d*-block elements have been experimentally manufactured and studied



Ribbon and bulk samples of amorphous metal alloys

Department of Intellectual Property

1, Universytetska Str., Lviv, 79000, Ukraine.

e-mail: a_pryimak@lnu.edu.ua, <http://www.lnu.edu.ua>, tel: +38 (032) 239-43-69



SUPPLEMENTARY Fe-Zn COATING FOR STRENGTH IMPROVEMENT OF STEEL PRODUCTS ADHESIVE BONDING WITH VARIOUS APPLICATION COATINGS

Purpose of invention and sphere of application

The invention relates to the field of metal-ware surface treatment, in particular to the preprocessing of steel products before applying metal, polymeric or composite coatings of various applications, and it is also designed to increase the strength and reliability of their adhesive bonding

Key benefits of invention

The invention allows obtaining the developed roughened surface of steel products in a more cost-effective way with lower capital and energy costs as compared to the world analogues

Intellectual property protection status

1 patent of Ukraine has been obtained

Standby status

The method of applying coatings has been developed, experimental prototypes have been obtained and tested

Essence of invention

The invention allows obtaining the developed roughened surface of steel products with an irregular microrelief due to the formation of a supplementary coating sublayer with a Fe-Zn alloy, which is deposited electrochemically from the proposed economic stannous sulphate electrolyte at a cathode current density of 8–12 A/dm² and a temperature of 50–60°C using soluble iron or steel anodes. After the support coating application, the roughness of the products surface made of low-carbon steel is: Ra = 4.5 μm, Rmax = 36 μm. Adhesion tests of polymer coatings based on aromatic polyamides applied on the developed Fe-Zn supplementary coating have shown an increase in adhesion strength to the level of cohesive polymer destruction

Market demand

The invention can be effectively used in the steel products preprocessing at the enterprises of mechanical engineering, metal treatment and automotive industry

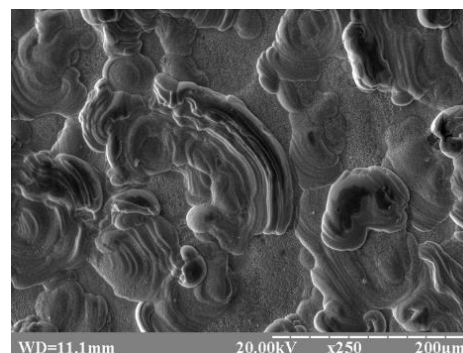
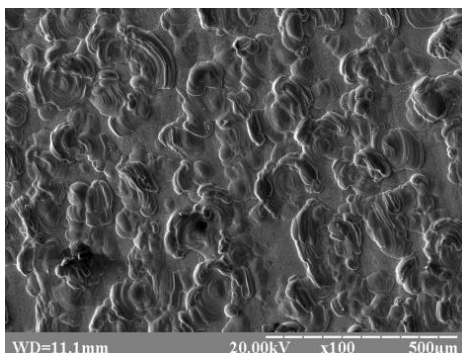

The developed morphology of the surface supplementary Fe-Zn coating on steel products

R&D Department, Department of R&D Information Support

2, Dniprobudivska Str., Kamianske, 51900, Ukraine
e-mail: science@dstu.dp.ua, <http://www.dstu.dp.ua>, tel /fax: (0569) 50-63-37



TECHNOLOGY OF FORMING MULTILAYER PROTECTIVE COATING ON THE WORKING SURFACE OF A CUTTING TOOL

Purpose of invention and sphere of application

The purpose of the invention is to increase the reliability of the tool at the stage of bedding-in, intensification of cutting parameters in the processing of hard-to-machine materials. The technology can be implemented at enterprises that produce cutting tools based on polycrystalline superhard material with elements of cubic boron nitride and have equipment for vacuum-plasma deposition

Essence of invention

The coating consists of three layers: the upper Al_2O_3 layer with thickness of $1.5 \mu\text{m}$, which helps to prevent the material oxidation of the working surfaces of the tool at high temperatures; the interlaminar NbN layer with thickness of $3.0 \mu\text{m}$, which reduces the abrasive adhesive fracture of the tool; the lower Ti layer with thickness of $0.5 \mu\text{m}$, which provides the adhesion strength of the coating-substrate contact

Intellectual property protection status

1 patent of Ukraine has been obtained

Market demand

The technology is in demand in the markets of Ukraine, Russia and Belarus

Key benefits of invention

The proposed technology of applying multifunctional nanocrystalline coatings to a cutting tool based on polycrystalline superhard material with elements of cubic boron nitride does not have domestic and foreign analogues

Standby status

Cutting tools are equipped with polycrystalline superhard materials based on cubic boron nitride with a protective coating of $\text{Al}_2\text{O}_3\text{-NbN-Ti}$, tested in industrial conditions at the Belarusian metallurgical plant and in laboratory conditions at the V. Bakul Institute for Superhard Materials of the National Academy of Sciences of Ukraine

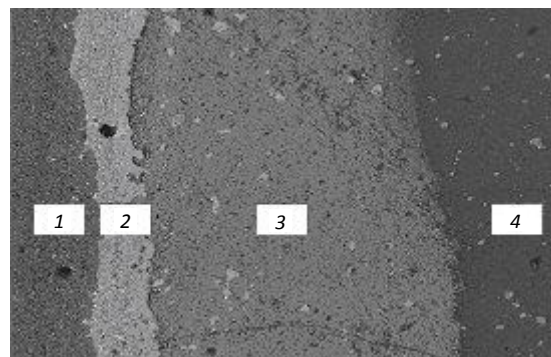

The cross-section of Ti-NbN- overlay on the surface of the cutting element: 1—base; 2 – Ti; 3 – NbN; 4 – Al_2O_3

Innovation Centre

6 Svobody Sq., Kharkiv, 61022, Ukraine

e-mail: innovation@karazin.ua, <http://innovation.karazin.ua>, tel /fax: +38(057) 705-52-89



STRENGTHENING OF SURFACE COATING MADE OF METAL ALLOYS

Purpose of invention and sphere of application

The developed method makes it possible to significantly increase the operational life of fast wearing parts and is aimed at a significant increase in the service life of the detail component or machine as a whole, increasing their reliability and durability, significantly reducing equipment downtime, lowering requirements for machinery and mechanisms operating conditions. This method may be used in mechanical engineering (including the military industrial complex), instrument engineering, polygraphic, refining, metallurgical and consumer goods industries

Essence of invention

The invention involves applying a reinforced coating of an inamorphic structure on the work surface, in which, due to the acquired morphology of the surface layer, surface hardness (up to 5.5–8.5 GPa) and, respectively, wear resistance in different environments increase. Depending on the type of reinforcing component and its material, operating conditions and work load as well as the environment, service life of the parts and machines in general has increased by from 1.8 to 4 times

Intellectual property protection status

4 patents of Ukraine on the invention have been obtained

Market demand

The method is applicable to wide components variety and due to its technical-economic values, can be implemented both in Ukraine and abroad



Bush and finger with a reinforced coating

Standby status

Route and postprocess technologies have been developed beginning with the selection of the work material, the method of its premachining and the detailed strengthening technology. The economic efficiency from implementation of the proposed method has been calculated

Department of Intellectual Property

1, Universytetska Str., Lviv, 79000, Ukraine.

e-mail: a_pryimak@lnu.edu.ua, <http://www.lnu.edu.ua>, tel: +38 (032) 239-43-69



MULTI-FUNCTIONAL CLUSTER SYSTEM FOR REACTIVE ION-PLASMA SYNTHESIS OF COMPLEX-COMPOSITE COMPOUNDS

Purpose of invention and sphere of application

The cluster functional unit is intended for synthesis and investigation of properties of nanostructured functional films and nanostructured elements. Synthesis technologies of single- and multi-layer nanotextured surfaces of oxides and oxynitrides of transition metal groups of TiN, TiAlN, TiO, Al₂O₃, Ta₂O₅, TiN/ Al₂O₃, TiN/TiO and others were well-proven with the unit. Nanostructured films and nanotextured surfaces are intended for the needs of mechanical and instrument engineering, nuclear energy and biomedicine

Key benefits of invention

The unit is original in design, more compact compared to the known analogues and capable of forming nanosized functional films and nanostructured elements with high resolution. The invention has low level of energy consumption, it may be operatively reconfigured and is twice more cost-effective compared to the known analogues

Market demand

The market demand is high. For the enterprises of mechanical engineering, instrument engineering and electronic industry – as technological equipment. For research institutions – as pilot experimental equipment

Standby status

Technological sample has been created. 80% of completion

Essence of invention

The cluster unit of reactive ion-plasma synthesis of complex-composite, reinforcing and corrosion-resistant coatings contains two low-pressure magnetrons with a target diameter of 170 mm, the "Radikal-M" type source of ions with energy of 2–5 keV with a beam diameter of 100 mm, which is mounted on the flanges of the working chamber, and high-frequency induction source of chemically active particles and plasma with an ion energy of 30-50 eV and a current density of up to 5 mA/cm²

Intellectual property protection status

Elements and clusters of the unit are protected with 3 patents of Ukraine





ELECTRODEPOSITION TECHNOLOGY OF MOS-8 AND OS-12 ALLOYS ON PLAIN BEARING LINERS FROM ELECTROLYTES BASED ON METHANESULFONIC ACID

Purpose of invention and sphere of application

The technology has been developed for antifriction coatings application with lead-based alloys — lead-tin-copper and lead-tin, used in the friction units of components and mechanisms

Essence of invention

The proposed electrolytes for alloys electrodeposition consist of metal methanesulfonates and composition of organic additives of MSA, which contains antioxidants and surface-active substances providing steady operation of the electrolyte. The finely crystalline light-gray matte coatings made of lead-tin-copper (90/8/2%) and lead-tin (88/12%) alloys with a fixed composition in a wide range of current densities (1–5 A / dm²) were obtained at the temperature of 18–25 °C

Key benefits of invention

The proposed technology is more environmentally friendly compared to the traditionally used boron fluoride technologies. The use of electrolytes based on methanesulfonic acid instead of boron fluoride solutions can significantly reduce the cost of sewage sanitation in electroplating industry. The proposed MSA composition inhibits the oxidation of Sn(II) ions, preventing the loss of an expensive electrolyte component, which also increases the economic competitiveness of the proposed technology



Intellectual property protection status

1 patent of Ukraine has been obtained

Market demand

The development results can be used at the enterprises of mechanical engineering, ferrous metallurgy, automobile and shipbuilding

Standby status

The R&D product has been completed. The technology has undergone laboratory and industrial testing

Department of R&D Products Commercialization

8, Haharina Ave., Dnipro, 49005, Ukraine

e-mail: udhtu@udhtu.edu.ua, www.udhtu.edu.ua, tel /fax: +38(0562) 47-33-97



NON-FLUORINE PIGMENT-FREE LIGHT-COLOURED ENAMEL COATING OBTAINING TECHNOLOGY

Purpose of invention and sphere of application

The invention concerns a new synthesis technology of non-fluorine pigment-free light-coloured enamel coating using adsorption and ion-exchange processes in the preparation of their suspensions. Glass-enamel coatings of yellow-cream, gray-blue, salad and olive colours are characterized by the absence of toxic and expensive components, the stability of the optical and colour indices of the coatings and are recommended for household and sanitary products

Essence of invention

Synthesized non-fluorine pigment-free light-coloured enamel coatings reduce the cost of enameled products due to the lower consumption (by 3 times) of the required dyes due to the use of only one basic frit for different coat colours and low firing temperature compared to the industrial coatings. The stability of the optical and colour indices of the coatings is achieved in a wide temperature range of firing (770–830° C) and meets the requirements of State Standard of Ukraine 3276-95

Intellectual property protection status

6 patents of Ukraine on the invention have been obtained

Market demand

The developed method of ionic enamel coatings colouring and their compositions can be widely used in the enameling industry for steel products manufacturing for household and technical purposes



Standby status

The developed method of ionic enamel coatings colouring and their compositions are ready to use and are implemented in the gas stove components manufacturing at the electro-gas equipment plant

Department of R&D Products Commercialization

8, Haharina Ave., Dnipro, 49005, Ukraine

e-mail: udhtu@udhtu.edu.ua, www.udhtu.edu.ua, tel /fax: +38(0562) 47-33-97

5. Power engineering and energy efficiency

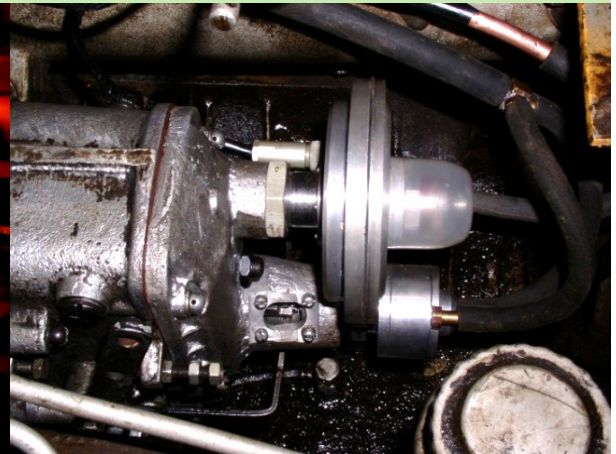



AUTOMATED ENERGY MANAGEMENT SYSTEM

Purpose and sphere of application

The I&C complex "Automated Energy Management System" is designed for the implementation of a continuous system for data monitoring, acquisition and processing from the metering devices and for the analytical system functioning in order to manage energy consumption processes in the municipal sector, further analyzing, forecasting the estimation of consumption levels and creating a cost plan for energy- and water supply

Intellectual property protection status

4 patents of Ukraine have been obtained and the intellectual property right for the software product has been registered

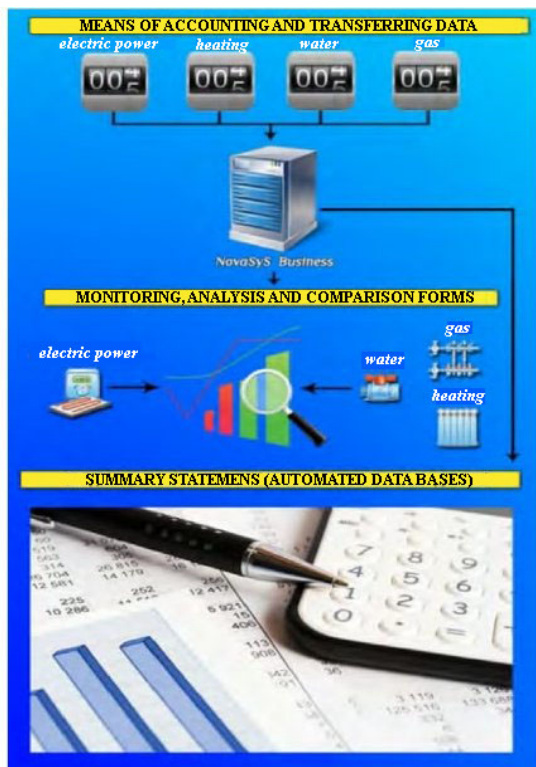

Essence of invention

The I&C complex is implemented on a unified modular platform with the ability to form an assigned configuration according to energy carriers types (NovaSys Business and NovaSys Report), to use technical and commercial systems for their accounting (ASKOE, LUZOD, etc.), to use monitoring systems of microclimate parameters, and to control operation modes of heat points and local energy sources. The complex provides real-time generation of databases on energy and water consumption with a discreteness of 30 minutes, the issuance of current and forecast consumption reports taking into account the season, work schedules of the institution, the number of inhabitants, tariff zones, etc. The structure, user interface and software implementation of data collection algorithms and information processing are adapted for the implementation of dynamic energy management in the municipal sector as an integrated energy management system based on resource-process object operation optimization in real time mode

Standby status

The production prototype has passed state metrological certification, has been accepted for operation, has been used in billing system of PJSC "Kyivenerho" for 4 years

Market demand

Such automated energy management systems can be implicated in educational institutions, housing cooperatives, scattered property complexes with a specific energy consumption level of more than 150 kWh/m²/year

Department of Intellectual Property

2, Nemyrovycha-Danchenka str., Kyiv, 01011, Ukraine
e-mail: nds@knutd.edu.ua, http://knutd.edu.ua, Tel./fax: +38 (044) 280-16-03



ENERGETICALLY BALANCED SYSTEM OF ENTERPRISE

Purpose and sphere of application

Engineering systems design for energy generation when consuming the most relevant type of fuel for a solid fuel boiler for a particular area and a particular enterprise

Key benefits of invention

In the former Soviet republics and in other countries of the world such an invention was not revealed. TEH (transport-energy hub) can be implemented both in stationary form and in the form of mobile system

Intellectual property protection status

1 patent of Ukraine has been obtained

Standby status

The design and technological documentation for the production of TEH at the "Gazgeneratorbau" enterprise (Dnipro town) has been developed

Essence of invention

The development is carried out in relation to the transport-energy hub (TEH) of the railway station, which generates thermal and electric energy and performs shunting work. In order to determine the necessary elements of this TEH, all generated and consumed energy had to be transferred to the thermal equivalent and the method of power balance had to be applied to the system. All elements of the system perform operation on the basis of the first law of thermodynamics (the amount of energy consumed is equivalent to the work performed). The calculation for one of the railway stations of JSC "Ukrzaliznytsia", subject to the introduction of the proposed THE, has shown a profit of about 12,000 euro per day

Market demand

Application of TEH is expedient not only in railway transport, but also in other branches of economy (oil refining, chemical, wood processing industry, sea and river ports and other enterprises)

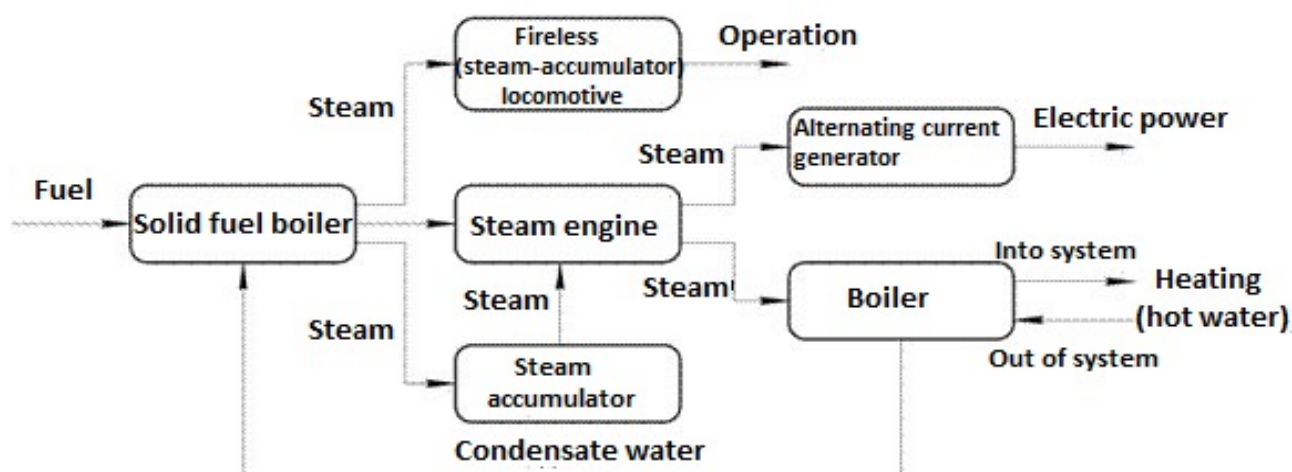

Scheme of energetically balanced system of enterprise

Department of Intellectual Property

2, Lazariana str., Dnipro, 49010, Ukraine

e-mail: Locdiit@i.ua, <http://diit.edu.ua>, Tel. +38 (056) 793-19-61, +38 (056) 373-15-34



HEATING SUPPLY MONITORING SYSTEM OF FACILITIES

Purpose of invention

The invention is intended for automated modes control of heat supply systems for socio-cultural and household facilities in the form of a single information system (service)

Intellectual property protection status

3 author's certificates of Ukraine on the software product have been obtained

Standby status

The software product has been implemented at Sumy State University

Market demand

The system has a significant potential for commercialization in organizations interested in improving their own energy efficiency and minimizing energy consumption expenditure

Essense of invention

The project is aimed at solving the applied problems of reducing the energy resources costs in heating supply systems for socio-cultural and household facilities. The system monitors the performance of the heating network taking into account the weather conditions, it calculates the required amount of thermal energy, and also creates the reporting documentation. The use of the system during heat consumption monitoring makes it possible to reduce the amount of heat energy consumption up to 15%

Performance-based characteristics:

- connection of up to 30 heat sensors and 4 pressure sensors;
- maximum distance between sensors and terminal is 150 m;
- data collection from heat energy meters with digital RS232 output

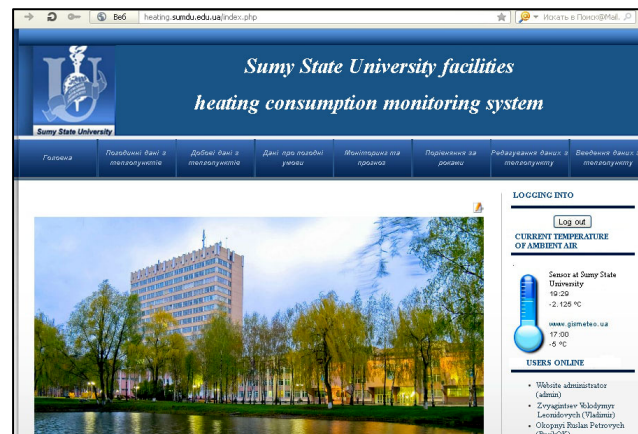



ENERGY ACTIVE FENCES AS A COMPONENT OF ENERGY SUPPLY SYSTEMS

Purpose of invention and sphere of application

Energy active fences are an integral part of the energy supply and environmental control system that perceives energy from renewable sources and can be applied in the construction and municipal sectors

Standby status

An experimental prototype of one of the variants of the energy active fences is made, the circuitry of power supply systems are also developed

Intellectual property protection status

2 patents of Ukraine on the utility model have been obtained

Essence of invention

Energy active fences restrict the building performing the role of the facades and the roof. The design perceives, transforms and redistributes solar radiation energy, promotes the accumulation of heat in a seasonal soil thermal accumulator, using it throughout the year with the help of heat pumps. Economic expediency is determined by a 2-3 times reduction of natural gas consumption in the municipal sector and partly in industry

Market demand

The large-scale implementation in housing and utilities infrastructure is advisable

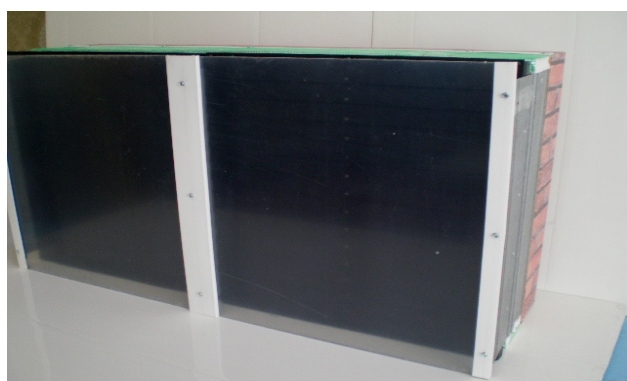

Solid carbon residue obtained due to the pelletized biomass

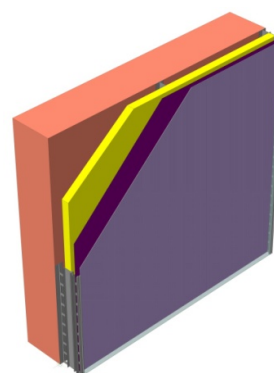

Carbon briquettes obtained with the wood addition

Department of Scientific and Technical Information

72, Haharina ave., Dnipro, 49010, Ukraine

e-mail: onti_dnu@i.ua, <http://www.dnu.dp.ua>, Tel.: +38(056) 760-93-54



ENERGY-EFFICIENT TECHNOLOGIES OF PORCELAIN PRODUCTS FOR VARIOUS PURPOSES

Purpose of invention and sphere of application

The complex of developments concerning energy-efficient technologies of electrical, household and chemical resistant porcelain intended for use by specialized domestic enterprises, provides a significant reduction of energy costs and expansion of the raw material base of production

Market demand

The demand for development is determined by the urgent need to introduce the energy-efficient import-substituting technologies at specialized enterprises, in particular, in "Druzhkovsky Porcelain Factory" Ltd., "Dovbysky Farforovy Zavod" Ltd., "Sumyfarfor" Ltd., PJSC "Pershotravenskyi Zavod Elektrotekhnichnoho Farforu", JSC "Slavic Factory of High-Voltage Insulators", "Olevsk Porcelain Plant" Ltd., which will promote the competitiveness of domestic products and increase the export potential of Ukraine

Intellectual property protection status

6 patents of Ukraine have been obtained

Essence of invention

Due to the use of alternative quartz-feldspar and aluminosilicate raw materials, the advantage of the developed technologies is the reduction of the burning temperature of products: sanitary-technical at 50° C, household appliances at 100° C and electrotechnical at 200° C, and the exclusion of glaze fritting compared to existing technologies, which determines the effect of energy-saving and a decrease in the dependence of domestic producers on the import of raw materials. The intensification of firing and phase formation under conditions of low temperature porcelain synthesis is ensured by the accelerated formation of a melt, directed to the regulation of its properties due to the complex chemical modification of mass compositions and watering

Standby status

Having undergone the tests in certified specialized laboratories the experimental batches of products have been manufactured. The developed technological production parameters ensure the implementation of a complete cycle of manufacturing of household, sanitary and electrotechnical products, which meet the requirements of the current standards



Samples of products from chemically resistant, economic, technical and electrotechnical porcelain

R&D Department

2, Kyrpychova str., Kharkiv, 61002, Ukraine
e-mail: nti@kpi.kharkov.ua, <http://www.kpi.kharkov.ua>, Tel /fax: +38(057) 707-62-13



ENERGY-EFFICIENT MANUFACTURING TECHNOLOGIES OF HIGH-STRENGTH FASTENING THREAD PRODUCTS

Purpose of invention and sphere of application

The technology is designed for the manufacture of rod fastening threaded products made of low-carbon or low-alloy steels, which can be used in the form of bolts, screws and studs with a strength limit of more than 800 MPa in threaded joints in mechanical engineering, automotive and other industries

Key benefits of invention

The technology makes it possible to guarantee the manufacture of rod fasteners with a quality grade of 8.8 and 9.8 according to the world requirements (ISO 898-1: 2013) and provides reduction of energy consumption and production cost (by 20%) by eliminating the operations of raw materials annealing and end products hardening, which positively affects the products competitiveness on the world market

Intellectual property protection status

3 patents of Ukraine have been obtained

Essence of invention

The technology includes a triad of coherent impacts, which are summarized: 1 – thermal strengthening of raw material (rolled wire); 2 – strengthening of the product by cold deformation during manufacturing; 3 – strengthening the finished product through tempering. It allows obtaining products with high consumer properties (high strength class) and reliability (high level of plastic properties) at lower production costs due the use of ordinary steel grades and reduction of the heat treatment costs (by annealing and bolts heating for hardening exclusion)

Market demand

The need for fastening products of the quality grade of 8.8 and 9.8 is estimated in hundreds of thousands of tons

Standby status

The parameters of the technology are well-proven. In the conditions of PJSC “Dniprometyz” an industrial batch of bolts of 8.8 quality grade has been manufactured

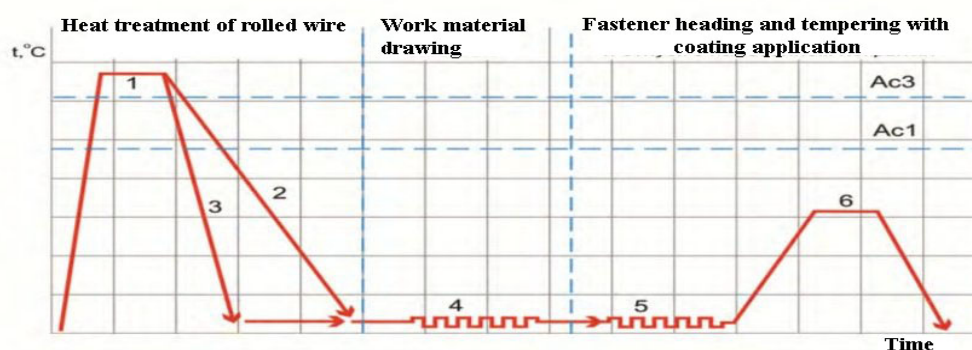

The manufacturing process scheme of high-strength fasteners

Department of Intellectual Property and Commercialization of R&D Products

4, Haharina ave., Dnipro, Ukraine, 49600

e-mail: projdak@metal.dmeti.dp.ua, <https://nmetau.edu.ua>, Tel./fax: +38(056) 745-41-96



ENERGY-EFFICIENT FURNACE CONSTRUCTIONS FOR ELECTRODE PRODUCTS GRAPHITIZING

Purpose of invention and sphere of application

The invention is designed for graphitizing electrode large capacity workpieces for ferrous and nonferrous metallurgy in steel-smelting electric arc furnaces, aluminum and magnesium electrolyzes

Intellectual property protection status

3 patents of Ukraine on the utility model have been obtained

Key benefits of invention

The developed energy-efficient constructions and operating regulations of the Kastner furnaces for graphitizing electrode large capacity workpieces which correspond to the analogues of the leading world producers of graphite products – SGL Carbon, MERSEN, GrafTech, TokaiCarbon have no analogues in Ukraine and furnish high quality electrode products providing higher productivity and lower specific electric power consumption

Market demand

Technologies of graphitizing electrode products in the Kastner furnaces compared to Acheson furnaces allow achieving a significant reduction of specific energy consumption by 20-25% and the duration of the graphitizing process, which determines their market demand

Standby status

The research has been completed. The development in the form of technical decisions, draft designs and software are ready for industrial application

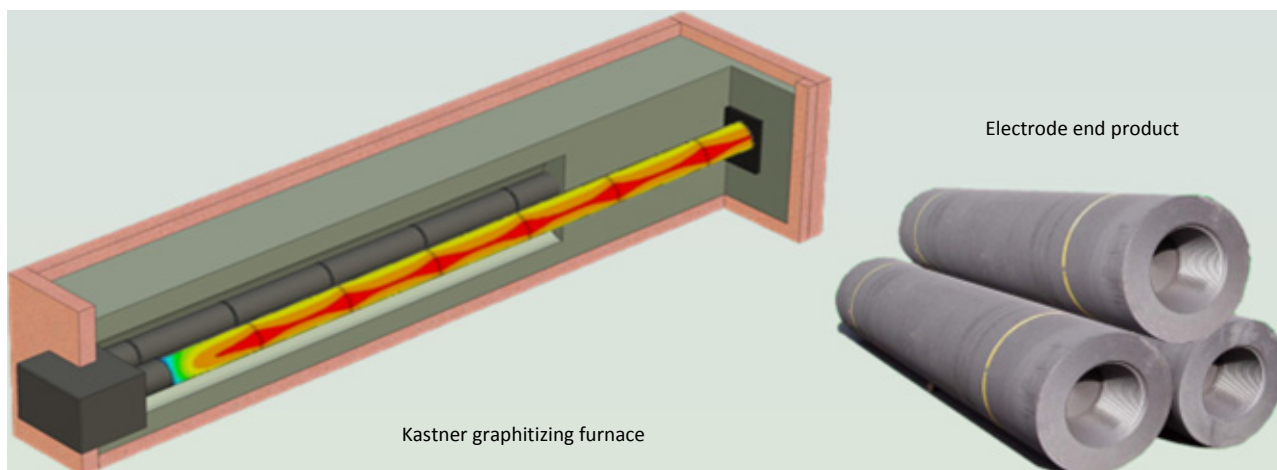

Department of Intellectual Property and Commercialization of R&D Products

37, Peremohy ave., Kyiv, 03056, Ukraine

e-mail: komerc.patent@kpi.ua, <http://www.kpi.ua>, Tel./fax: +38(044) 236-40-56



EXTRA-FURNACE PROCESSING TECHNOLOGY OF IRON-CARBON MELTS

Purpose of invention and sphere of application

The development concerns the processes of refining and modification of iron-carbon melts with active reagents that are recovered in the melt volume due to the heat of an electric arc. Through this process a significant reduction in the final product cost is achieved due to the refusal of expensive materials containing magnesium metal or calcium. Potential users of the developed technology are domestic enterprises that incorporate foundry and metallurgical lines using liquid metal melts

Key benefits of invention

The most important indicators of the extra-furnace processing technology of iron-carbon melts for the purpose of their refinement and modification by the method of submerged electric arc include high resource- and energy efficiency, the possibility of refusal in the production cycle from the use of expensive substances for the refining, modification and alloying of melts

Market demand

The developed technology may be implemented without significant capital expenditures at domestic metallurgical enterprises equipped with the "ladle furnace" unit. Besides, in case of certain re-equipment, it can be used at any foundry or metallurgical enterprise

Essence of invention

The maximum degree of cast iron desulphurisation comprised 97.2% with a magnesium utilization rate of 98.14%. The heating rate of the melt is 10-14° C/min with a thermal efficiency of 75-80%

Standby status

The method for parameters calculation of iron-carbon melt processing with an submerged electric arc has been developed, which ensures specified sulfur content reception and compensation of heat losses during processing. In semi-industrial conditions, the processing of pig iron with magnesium was completed where magnesium was restored from the oxide in the zone of the electric arc immersed in metal

Intellectual property protection status

3 patents of Ukraine have been obtained



Department of Intellectual Property and Commercialization of R&D Products

4, Haharina ave., Dnipro, Ukraine, 49600

e-mail: projdak@metal.dmeti.dp.ua, <https://nmetau.edu.ua>, Tel./fax: +38(056) 745-41-96



EXTRA-FURNACE CAST IRON DESULPHURIZATION BY MAGNESIUM TECHNOLOGY

Purpose and sphere of application

The invention is designed for the refining of molten cast iron from sulfur by using magnesium, which is reduced from oxide in the volume of molten cast iron. The invention allows implementing the extra-furnace cast iron desulphurization technology in the metallurgical and foundry industries without significant changes in the production cycle.

Key benefits of invention

The most important values of the technology include high resource and energy efficiency, the possibility of introducing the extra-furnace cast iron desulphurization technology at enterprises without the use of any additional technological equipment



Process of extra-furnace cast iron desulfurization by magnesium reduced from oxide in the volume of liquid melt by virtue of parallel chemical conversions heat

Essence of invention

The method has been developed for determining the energetically and economically justified mixture composition for magnesium remanufacturing from the oxide in the melt volume due to the heat of parallel chemical transformations. The maximum degree of cast iron desulphurization comprised 70% (in laboratory conditions) with the initial sulfur content of 0.032% and the cost of exothermic mixture in the briquettes form of 15-20 kg/ton of cast iron; chrome iron (in industrial conditions) – 40%, with the initial sulfur content of 0.14% and the cost of exothermic mixture in a powder form of 10 kg/ton of cast iron

Market demand

The developed technology may be implemented without significant capital expenditures at domestic metallurgical and foundry enterprises, where there is a need for conducting extra-assembly cast iron desulphurization

Standby status

The cast iron processing with magnesium has been successfully performed under laboratory and industrial conditions, and the effectiveness of the proposed technology has been verified

Intellectual property protection status

2 patents of Ukraine have been obtained

Department of Intellectual Property and Commercialization of R&D Products

4, Haharina ave., Dnipro, Ukraine, 49600

e-mail: projdak@metal.dmeti.dp.ua, <https://nmetau.edu.ua>, Tel./fax: +38(056) 745-41-96



COMPREHENSIVE ASSESSMENT OF LIFE EXTENSION OPTION OF HIGH-POWER STEAM TURBINES

Purpose of invention and sphere of application

TPP and NPP life extension with the possibility to assess the power equipment remaining life and to analyse the start-stop characteristics of the TPP, CHP and NPPs equipment

Key benefits of invention

For the first time a research testing of the condition of metal rotor made of 25Kh1MF grade steel has been carried out, considering low-cycle fatigue, creep, stress-rupture strength and torsional oscillations of turbine elements that have worked 220-275 thousand hours in the real operation conditions at Luhanska and Kurakhovska TPPs. The payback period of the invention is one year, excluding the cost of the automated diagnostic system

Intellectual property protection status

2 copyright protection documents on objects of intellectual property right of Ukraine have been obtained

Market demand

The operating results are used by enterprises of power generating companies of the Ministry of Energy and Coal Industry of Ukraine and DTEK Energy (power units with a capacity of: 220 MW – 4 units and 1000 MW – 13 units for NPP, 200 MW – 42 units, 300 MW – up to 43 units and 800 MW – 7 units for the TPP and 100-150 MW for the CHP plant)

Essence of invention

Comprehensive assessment of the possibility of extending the operating life of the power equipment considers: the technical audit data on the damage to steam turbines and the actual operating conditions; the damage on the basis of experimental research of metal high-temperature elements of steam turbines. Consideration of this assessment will allow extending the operating life of steam turbines with the power of 200-800 MW, the output of which is more than 220 thousand hours and 800 startups, up to 350 thousand per hour. This will provide an approximate economic effect of 7.23 million UAH per annum for a TPP unit of 200 MW power power and 35.4 million UAH per annum for the NPP unit with a power of 1000 MW

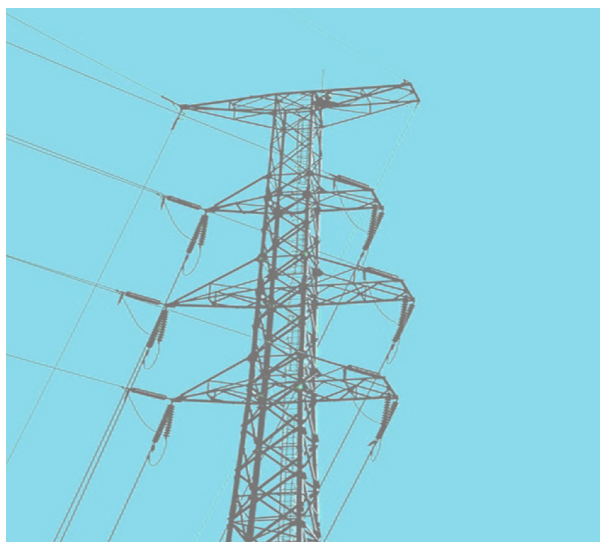

Standby status

The invention is currently at the stage of the industrial implementation; appropriate acts have been provided

Department of Intellectual Property and Commercialization of R&D Products

37, Peremohy ave., Kyiv, 03056, Ukraine
e-mail: komerc.patent@kpi.ua, <http://www.kpi.ua>, Tel./fax: +38(044) 236-40-56



ALTERNATIVE FUELS AND REDUCING AGENTS FOR METALLURGICAL PROCESSES

Purpose and sphere of application

Fuels and reducing agents produced from renewable carbonaceous materials instead of combustible minerals may be used in metallurgical processes (such as sintering, in electric arc furnaces, direct reduction and blowing into blast furnace) as well as in chemical industry. It will allow for reduction of the metallurgy dependence on fossil fuels and their derivative products, as well as production of both fuel and reducing agents of the specified quality (with such parameters as size, strength, chemical reaction qualities, element and proximate analysis), recycling of biomass processing waste, improvement of the technical and economic performance of metallurgical plants, reduction of the emissions of harmful substances

Market demand

A lot of industries have different requirements for fuels and reducing agents with sustainable properties and relatively low cost. The developed alternative fuels and reducing agents meet these requirements



Solid carbonaceous waste obtained with the addition of pelletized biomass

Essence of invention

The essence of the invention consists in direct pyrolysis of solid biomass mixed with coal. By changing the heat treatment conditions that depend on the properties of raw materials it becomes possible to obtain a product of required quality appropriate for use in metallurgical processes. Alternative fuels and reducing agents production is aimed at meeting the requirements of specific metallurgical processes, taking into account modern condition of metallurgical equipment, its modes and operation aspects

Intellectual property protection status

1 patent of Ukraine on a utility model has been obtained

Standby status

Conditions have been optimized and laboratory samples of fuels and reducing agents have been obtained comprising solid biomass of various properties, coarseness and shapes ready for implementation



Carbonaceous briquettes obtained with the addition of wood

Department of Intellectual Property and Commercialization of R&D Products

4, Haharina ave., Dnipro, Ukraine, 49600

e-mail: projdak@metal.dmeti.dp.ua, <https://nmetau.edu.ua>, Tel./fax: +38(056) 745-41-96



IMPROVEMENT OF ENERGY EFFICIENCY OF REFRIGERATION EQUIPMENT

Purpose of invention

The technology of production of nano-oils, nanorefrigerants and nano-heat-transfer mediums and regulation of their heat-exchange properties and characteristics is designed with the aim of decreasing energy cost for refrigeration production. The conceptual difference of the present technology from its prototypes is a complex consideration of nanofluids properties and characteristics of their heat-exchange. Application of the present technology will allow for decrease in energy consumption of installed refrigeration equipment and the material intensity of heat-exchangers in use

Intellectual property protection status

2 patents on a utility model have been obtained

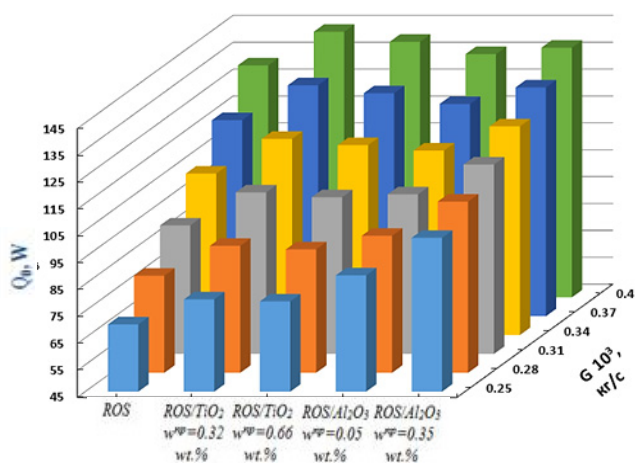

The value of cooling capacity for working bodies (ROS/nanoparticles) at different costs

Essence of invention

Energy consumption of the refrigeration compressor operation is decreased by 5-10%. Heat-transfer coefficient is increased as well as material intensity of heat-exchangers (evaporators and condensers) in use is decreased by 5-10%. Basic fluids for nanofluids production are refrigerants, compressor oil, heat-transfer and cooling mediums. Nanoparticles being applied are metals, metal oxides and fullerenes

Standby status

The technology of production of nano-oils, nanorefrigerants and nano-heat-transfer mediums has been developed. Their thermophysical properties, the effect of nanoparticles on compression system energy efficiency as well as on a heat-transfer coefficient during nanofluid boiling and forced convection have been studied

Market demand

Developed nanofluids will be in demand among the producers of service fluids and their consumers with the aim of competitive growth of the produced goods (refrigeration equipment, transformer cooling systems, combustion engine cooling systems, radio-electronic devices (including dual-purpose devices))

Department of Regulatory and Engineering Provisions and Metrology

112, Kanatna str., Odesa, Ukraine, 65039,

e-mail: nauka@onaft.edu.ua, www.udhtu.edu.ua Tel./Fax. +38 (048) 712-41-30, +38(048) 724-28-75



ENGINE GAS AND DIESEL FEED AND ADJUSTMENT SYSTEM

Purpose of invention and sphere of application

The developed gas and diesel system is designed to be refitted into mid-capacity diesel in GD engines at motor transport enterprises. This system allows diesel engines operation on diesel oil fuel and compressed natural gas mixture in a gas-diesel cycle, without sacrificing standard fuel feed system

Market demand

The invention may be much-in-demand due to its salient economic benefits and short payback period of the finances invested in the refitting of engines

Intellectual property protection status

The invention is protected by the patent of Ukraine

Standby status

Scientific research has been conducted; and the key benefits of the product have been confirmed by the demonstration of the BelAZ 75405 refitted GD engine

Essence of invention

Gas and diesel system features high efficiency, rugged design and simplicity of operation. The application of this system allows decrease in petroleum-product fuel consumption up to 70%; retaining basic diesel energy characteristics; reduction of diesel engine exhaust toxicity; and above that it reduces dramatically motor transportation net cost by means of interchanging petroleum-product fuel by cheaper gas fuel

Key benefits of invention

The developed gas and diesel system allows reduction of fuel costs for vehicle and stationary power installations. The annual economic benefit for the BelAZ 75405 is 150-200 thousand hryvnias. Anticipated payback period doesn't exceed 0.3-0.5 year. The developed gas and diesel system has the performance standards of the BOSCH DG-Flex gas and diesel system



Gas and diesel BelAZ 75405

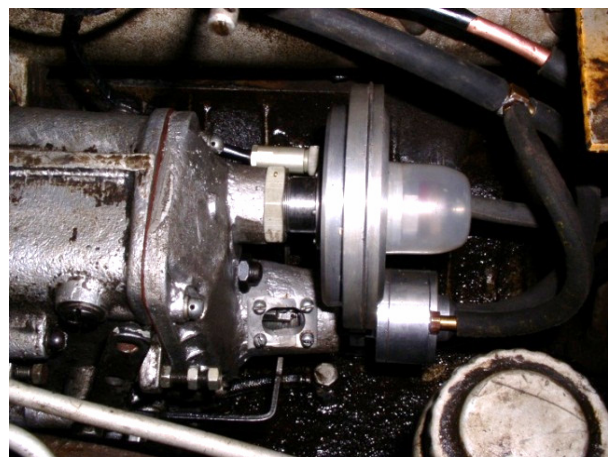

Installation of unit assemblies on the engine

Department of Intellectual Property and Commercialization of R&D Products

37, Peremohy ave., Kyiv, 03056, Ukraine

e-mail: komerc.patent@kpi.ua, <http://www.kpi.ua>, Tel./fax: +38(044) 236-40-56



ACOUSTIC TECHNOLOGY FOR YIELD INCREASE IN OIL, GAS CONDENSATE AND WATER-SUPPLY WELL

Purpose of invention and sphere of application

Improvement of the wells operating efficiency at the different stages of their treatment is the most promising area in the oil and gas extraction industry

Key benefits of invention

The technology and equipment, based on it, have the variety of substantial benefits as compared to the existing equipment: application of high temperature piezoceramic transducers instead of magnetostrictive ones in transmitters allows the increase of an electromechanical coupling factor no less than by one third. Apart from this, multifrequency ultrasonic radiation improves acoustic effect on the physical and chemical processes of productive stratum-water interface, which results in increase in oil and/or gas condensate influx



Transmitter and generator

Essence of invention

The technology of acoustic effect on productive strata allows the increase in oil and gas recovery factor of oil, gas condensate and water-supply wells by several times (from 15 to 300%), by virtue of damaged formation and low-permeability zones dissipation. The equipment consists of a ground power source (generator component) and a well-logging tool-transmitter produced on the basis of piezoceramic transducers. Watt consumption is 5 kW

Intellectual property protection status

The patents of Ukraine and the Russian Federation have been obtained

Market demand

The invention is in demand on the Ukrainian and international markets

Standby status

The invention has already been placed on the market

Innovation Centre

6, Svobody sq., Kharkiv, Ukraine, 61022.

e-mail: innovation@karazin.ua, <http://innovation.karazin.ua>, Tel./fax: +38(057) 705-52-89



TECHNOLOGY OF POWER GAS PRODUCTION FOR COGENERATION UNITS

Purpose of application and sphere of application

Potential users of the invention are enterprises, focused on the treatment of biomass of various types, agricultural sector, household consumers of heat and electric power. Types of fuels being applied are green wastes (chipped wood, bark etc); agricultural residuals (sunflower hulls, buckwheat husks, rice hulls, straw, cornstalks, sunflower stalks etc.), biomass pellets

Key benefits of invention

The project innovation consists in an application of the two-stage biomass gasification technology. The key benefits of the two-stage technology are: decrease of the resin content in synthetic gas up to 6.5-7.1 mg/m³, that is 2.5 times lower than the one in the gas produced by the application of existing biomass treatment technologies; use of a biomass with significant humidity (up to 50%) without preprocessing; application of biomass as fuel allows reduction of air emissions of harmful substances; reduction of heat and electric power expenditure: waste of energy in networks is nearly non-existent as cogeneration units are situated in the places of heat and electric power consumption

Essence of invention

Power range of the cogeneration unit: electric capacity – 10-100 kW; heat power – 60-600 kW. In the process of gasification synthetic gas with heating value of 5-8 MJ/m³ is produced. Major chemical components of the gas are CO, CO₂, CH₄, H₂, N₂

Market demand

The invention will be much-in-demand on the market due to the energy police of Ukraine, aimed at the waiver of purchased natural gas

Standby status

2 pilot semi industrial units with discharged fuel capacity of 75 and 100 kW have been produced. Production of the industrial model of the cogeneration unit fitted with an automated biomass loading system, heat-exchange and pumping equipment, internal combustion engine and an automation system is required

Intellectual property protection status

3 patents of Ukraine have been obtained



Synthetic gas production unit

Department of Intellectual Property and Commercialization of R&D Products

4, Haharina ave., Dnipro, Ukraine, 49600

e-mail: projdak@metal.dmeti.dp.ua, <https://nmetau.edu.ua>, Tel./fax: +38(056) 745-41-96



MULTIPURPOSE JET-NICHE BURNERS

Purpose of invention and sphere of application

The invention is designed to implement an energy-efficient incessant process of gas burning in the atmosphere and feed of combustion products to combustion space of power-plant boilers, industrial boilers, industrial furnaces, drying installations of different types and air heaters

Key benefits of invention

A much broader range of a turn down ratio up to 10 (at the rate of 5) and the capability of operation with the variation of excess air factor from 1.02 to 10 (in conventional substitutes - from 1.02 to 1.3) have been obtained. Electric energy consumption for forced-draft fan drives has been reduced by 1.5-2 times

Intellectual property protection status

The developed technology and burner arrangements are protected with 5 patents of Ukraine

Market demand

The product will be in-demand by industrial fire engineering facilities and heating plants of housing and utility sector, equipped with boilers of the following types: DKWr, NIISTU-5, KWT, PTW, furnaces and preheaters. The payback period of burner arrangements are 1.5-2 years

Essence of invention

Application of the gas- and airflow jet mixing in the system of modular jet-niche burners enables more rapid combustion and formation of short flame with the minimal excess air factor

Standby status

The technology and engineering documentation of burner arrangements have been developed; works on multipurpose jet-niche burner implementation in the energy and industry sectors are being conducted





EXPANSION TURBINES BASED ON JET-REACTIVE AND VORTEX TURBINES

Purpose of invention

Expansion turbines based on jet-reactive (ET-JRT) and vortex (ET-VT) turbines, are designed to generate electric power from compressed gas and vapour energy that is currently being wasted in pressure control and pressure-reducing valves

Essence of invention

The main component of ET-JRT, that determines its potential and main benefits, is a bladeless jet-reactive turbine. The operating principle of a jet-reactive turbine is based on the transformation of potential condensate gas energy into kinetic energy of the jet, flowing from a thrust nozzle and located at a certain distance from the axis of rotation. The ET-JRT consists of the turboexpander based on a jet-reactive turbine; single-stage reducer; induction motor serving as three-phase alternator; automatic control, monitoring and protection system; generated power connection and control system

Key benefits of invention

Existing world analogues are characterized by relatively huge capital expenses that do not allow minimally acceptable payback period. The benefits of jet-reactive turbines allow production of expansion turbines with a payback period of 1-2 years; they are cheaper units, of simple technology and design as well as more convenient and reliable in operation in comparison with expansion turbines based on conventional bladed turbine

ET-JRT unit-100/130-5,5/0,6VRD

Parameters	Value
Power, kW	100
Max throttle pressure, atm	64
Nom throttle pressure, atm	55
Min throttle pressure, atm	6
Gas flow for heating, kg/s	1.1-1.4
Turbo-generator unit weight, kg	1670
Dimensional specifications, mm	1500;700;800

Intellectual property protection status

3 patents of Ukraine on the invention and utility model have been obtained

Market demand

The invention may be applied for gas-distribution plants, serving for gas expansion to the level required under the terms of its safe consumption

Standby status

The invention has already been implemented at industrial enterprises



Expansion turbine – an electric power generation unit

R&D Department, Centre of Scientific, Technical and Economic information

2, Rymskoho-Korsakova str., Sumy, 40007, Ukraine
e-mail: dkurbatov@sumdu.edu.ua, info@cni.sumdu.edu.ua, Tel./fax: +38 (0542)



JET THERMAL TRANSFORMER FOR HEAT AND COLD SUPPLY SYSTEMS

Purpose of invention

Among alternative methods of heat supply, rational from the perspective of the exergy improvement of energy conversion, the method of reductive thermal conversion is distinguished. It combines joint implementation of direct and reverse cycles, e.g. in reductive absorption heat pumps or heat-engine-driven heat pumps



Market demand

The product will be in demand in heat power industry and heat-process engineering, public services etc., in particular heat and cold supply for public use; centralized heat supply, year-round air conditioning

Essence of invention

The combination of direct and reverse cycles with the implementation of jet thermal compression allows attainment of higher conversion efficiencies in step-down thermal transformers. Modernization of heating source is possible to be performed by taking 60-70% of unprofitable boilers out of service, and refitting of the remained ones with jet thermal transformer blocks (operating boilers are used as operating fluid heaters). The invention usage allows annual energy saving of 20-25% in public sector buildings

Intellectual property protection status

3 patents of Ukraine on the invention and utility model have been obtained

Key benefits of invention

Heat coefficient is 2-3 times higher than the one of the analogues.
Efficiency factor is 2 times higher than the one of boiler units.
Fuel-consumption rate is 4-5 times lower than the one of boiler units.
Power consumption is 4 times lower than the one of reverse cycle heating

Standby status

The invention has already been implemented at industrial enterprises

R&D Department, Centre of Scientific, Technical and Economic information

2, Rymskoho-Korsakova str., Sumy, 40007, Ukraine
e-mail: dkurbatov@sumdu.edu.ua, info@cni.sumdu.edu.ua, Tel./fax: +38 (0542)



HEAT-GENERATING UNIT

Purpose of invention

The heat-generating unit is a highly efficient heat energy source of a hydro-dynamic operation principle, in which continuous conversion of the mechanical power of a drive motor into the heat power of operation environment takes place.

Essence of invention

Fluid heating is conducted by virtue of viscous friction force which permits to stop the use of heating elements

Unit	Power / motor frequency, kW / (r / min)	Dimensions, mm	Heating area, m ²
TGA-M	3/1500	562×263×235	50
TGA-1	7,5/1500	730×350×302	125
TGA-2	15/1500	924×430×358	250
TGA-3	30/1500	1012×470×410	500
TGA-4	55/1500	1250×450×500	900
TGA-5	110/1500	1380×550×640	1800

Key benefits of invention

- Application of an automatic control system.
- Capability of being installed in non-gas areas.
- Elimination of a heat loss in heating mains.
- Capability of stepless temperature control from 10 to 85 °C.
 - Elimination of heating elements and preliminary water treatment.
 - Elimination of combustion products emission into the air.
 - Capability of direct connection to the existing heating circuit.
 - Heat energy accumulation in storage tanks during nighttime hours.
 - Reduction of heating costs by 40-60%

Market demand

The invention may be applied for administrative, residential, industrial and storage buildings and greenhouses, hot water supply, heating of liquids without local heat supply

Standby status

The invention has already been implemented at industrial enterprises

Intellectual property protection status

4 patents of Ukraine on the inventions and utility models have been obtained

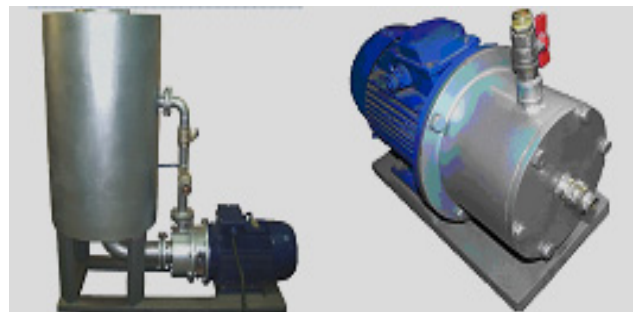

R&D Department, Centre of Scientific, Technical and Economic information

2, Rymyskoho-Korsakova str., Sumy, 40007, Ukraine

e-mail: dkurbatov@sumdu.edu.ua, info@cni.sumdu.edu.ua, Tel./fax: +38 (0542)



FLEXIBLE PHOTOVOLTAIC SOLAR ENERGY CONVERTERS

Purpose and sphere of application

The solar energy generation under the solar radiation. Autonomous flexible and ultra-light power supplies of low and medium power levels

Essence of invention

The mini-module implemented in practice consists of 20 photovoltaic converters and generates current and voltage of $J_m = 2,1 \text{ mA/cm}^2$, $U_m = 2,2 \text{ V}$, respectively, at the maximum power point

Key benefits of invention

Flexible photovoltaic solar energy converters are designed on the basis of the CdS/CdTe heterosystem. The most important factor is the output specific power, which is 2.5 kW/kg for individual solar cells with 11.4% efficiency and is 1.9 kW/kg for a mini-module with 4.6% efficiency. The world's best industrial analogues are solar batteries with the three-stage photovoltaic converters InGaP/GaAs/Ge that operate under concentrated solar radiation and have output specific power of 0.18 kW/kg

Market demand

Mobile electronic devices of all kinds, including unmanned aerial vehicles, and vehicle refrigeration units, can be equipped with the flexible photovoltaic converters

Intellectual property protection status

3 patents of Ukraine on the invention have been obtained

Standby status

The laboratory prototype has been produced; the laboratory technology has been improved

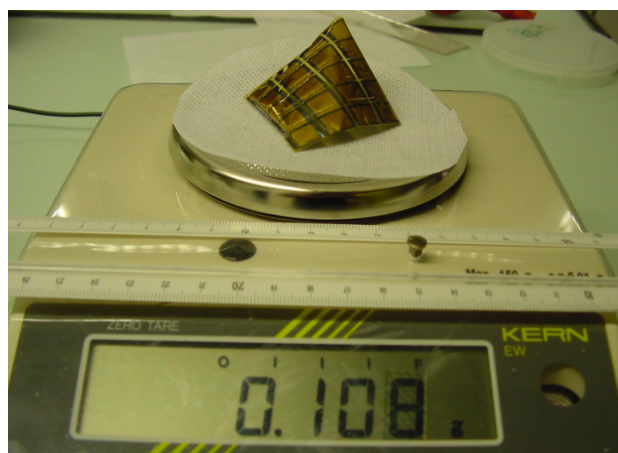
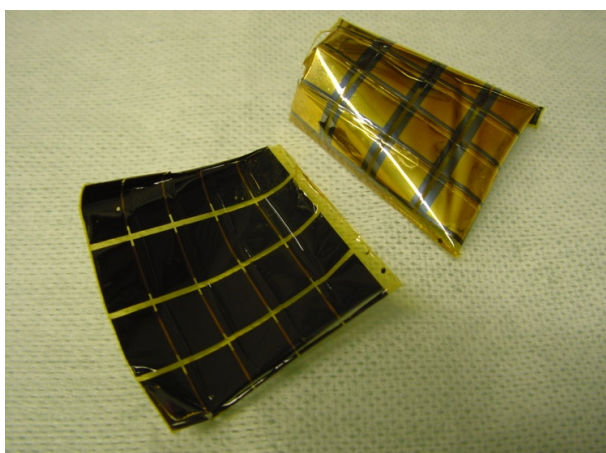

The mini-module of photovoltaic solar energy converters based on CdS/CdTe heterosystem

R&D Department

2, Kyrpychova str., Kharkiv, 61002, Ukraine
e-mail: nti@kpi.kharkov.ua, <http://www.kpi.kharkov.ua>, Tel /fax: +38(057) 707-62-13



LED EMERGENCY LIGHTS

Purpose of invention and sphere of application

LED emergency lights are devices which turn on automatically in case the damage or power outage of the routine lighting occurs. LED emergency lights shall be used as alternative illuminating equipment with the connection to a power source, autonomous from the routine lighting power supply. They may be used in different sectors of national economy: office and administrative buildings, hospitals, schools, commercial and industrial premises, underground constructions as well as sports complexes, expocentres, railway stations, airports etc.

Key benefits of invention

The designed devices have significantly lower power consumption (2-3 times lower against the existing fluorescent lamps) and lower maintenance costs along with the significant increase of operational lifetime (up to 50 thousand hours), significant increase in reliability and information value, as well as expansion of functionalities. The developed and produced experimental prototypes of LED emergency lights are designed at the level of the best world models

Standby status

Experimental prototypes produced have passed the performance tests, functional diagrams of the electrics have been tested; and anticipated technical characteristics have been proven

Essence of invention

LED emergency lights have the following technical characteristics: power – 5 W; voltage – 220 V (or 12 V battery); luminous flux – 350 lm; scattering angle – 140°; number of LEDs – 28; inertialess switching on and off $t < 100\text{ns}$; IP degree of protection – IP65; high reliability within wide temperature range from -40°C to $+60^{\circ}\text{C}$; regarding service conditions, they operate as unattended devices. LED emergency lights operate up to 12 hours without recharging in two modes: H – high-intensity light and L- low intensity light.

Market demand

The results of the invention development may be used for the mass production of LED emergency lights for the development of energy-efficient lighting technologies in Ukraine

Intellectual property protection status

5 patents of Ukraine have been obtained



Department of Intellectual Property

95, Khmelnytske Shose str., Vinnytsia, 21021, Ukraine

e-mail: vntu@vntu.edu.ua, <http://vntu.edu.ua/>, Tel: +38(0432) 56-08-48, fax: +38(0432) 46-57-72



LITHIUM BATTERIES WITH A LONG STORAGE PERIOD

Key features

The approaches to the creation of a lithium power supply (LPS) of the Li-FeS₂ system have been developed. The LPS combines high specific weight and volume energy characteristics; low self-discharge providing long-term storage (up to 15 years) without loss of power characteristics and power; operability within a wide temperature range (up to -25 °C); low cost; technological capability of scalability.

The specific energy of the developed power supply after the charge activation is 340 W*h/kg, this is about 30% higher against the similar Li-FeS₂ Energizer Ultimate Lithium AA power source (250 W*h/kg); and 41% higher than the specific energy of the chemical AAA power sources (200 W*h/kg) as well



Lithium power sources

Essence of invention

The developed backup power supplies are economically attractive due to cheap constituent elements (FeS₂). They are energy-competitive due to the high specific energy of the electrochemical system and specially developed double-layer enclosure, cathode manufacturing technology, and lithium-based anode modifications

Intellectual property protection status

1 patent of Ukraine has been obtained

Market demand

The product may be in-demand in civil instrument-making, defence and space industries

Standby status

The research prototype of the developed power supply has been produced. The documentation for the production of the research prototype of the developed power supply has been prepared. Independent testing of research prototypes of backup lithium power supplies has been carried out in the Laboratory of alternative and renewable energy sources (the Institute of Semiconductor Physics of the National Academy of Sciences of Ukraine)

Department of R&D Products Commercialization

8, Haharina ave., Dnipro, 49005, Ukraine

e-mail: udhtu@udhtu.edu.ua, www.udhtu.edu.ua, Tel /fax: +38(0562) 47-33-97

6. Mechanical engineering

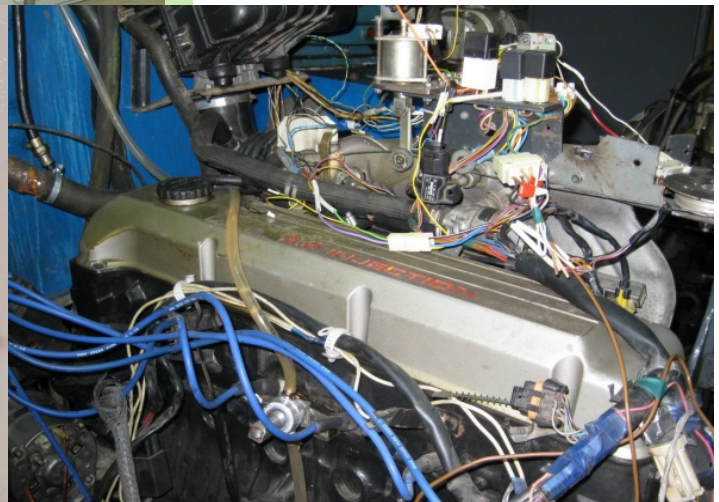
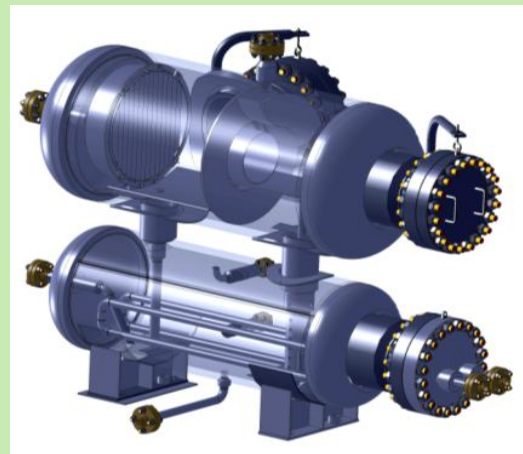



ROTATING SUBMERSIBLE TUYERE FOR LADLE MELT REFINING

Purpose of invention

The invention is developed for the ladle refining of molten metals by gas and/or gas-powder jets blowing deep into a bath, ensuring efficient distribution of gas and solid reagents by the bath volume

Market demand

Converter and casting shops of Ukrainian and foreign metallurgical enterprises can be equipped with such tuyeres.

Standby status

Laboratory prototype of the invention has been produced; high-temperature experimental laboratory tests have been performed; and the anticipated characteristics have been confirmed

Essense of invention

The principle of the homogeneous distribution of mixing or refining gas and solid powder-like reagents by the volume of the ladle bath with intensification of mixing and elimination of stagnation zones has been applied. Dispersed magnesium blowing into the cast iron melt for desulphurization with the increase in specific intensity and extent of desulphurization by 24% and 18% respectively, with the reduction of magnesium consumption by 30% and duration of processing time by 25%, has been provided. Submersible multinozzle tuyere blows gas and/or gas-powder jets deep into metal melts in the ladle with rotation around the axis mechanism; its rotation speed is from 0 to 200 rpm. The capability to reduce the "freeboard" in a ladle is up to 300-350 mm

Intellectual property protection status

3 patents of Ukraine have been obtained

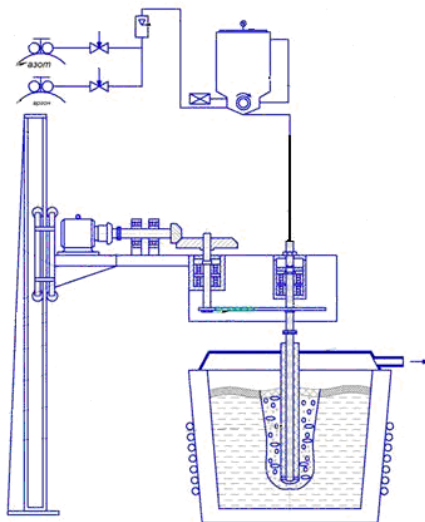

R&D Department, Department of R&D Information Support

2, Dniprobudivska str., Kamianske, Ukraine, 51900

e-mail: science@dstu.dp.ua; <http://www.dstu.dp.ua> Tel./Fax: (0569) 50-63-37



OXYGEN TWO-LEVEL TUYERE FOR CONVERTER BATH BLASTING AND SLAG MELT SPLASHING

Purpose of invention

The invention is developed for converter bath blasting in a basic-oxygen furnace with prevention of the tuyere metallization, ensuring a smooth blasting process and partial afterburning of exhaust gases with a heat transfer to a bath. It allows effective splashing of the final converter slag on the converter lining

Intellectual property protection status

The patent of Ukraine has been obtained

Market demand

Converter shops of Ukrainian and foreign metallurgical enterprises can be equipped with such tuyeres

Standby status

Industrial prototype has been produced; experimental industrial tests have been performed; and the anticipated characteristics have been confirmed

Essence of invention

The resistance of solid-turned tuyere head has been increased by 2.5 times against regular welded heads. Upper nozzle block has 8-24-cylinder nozzles to form a screen of oxygen (3-10% of the primary oxygen consumption) or nitrogen jets. The following technical characteristics have been provided: prevention of the equipment metallization, increase of the specific oxygen injection rate by 12-15%, reduction of the blowing period by 3.5%, increase in the dephosphorization degree of the melt and product yield by 4.0% and 0.15% respectively, reduction of sulfur content by 0,002%, increase in the share of scrap in metal charge by 3.0%.

The principle of the oxygen flow fixed separation or two controlled flows of the primary and additional oxygen with possibility to be replaced by nitrogen during the bath blasting has been applied in the invention design. Subsonic oxygen jets from the upper nozzle block create a screen over the blast zone with partial afterburning of waste gases; they prevent the intensive removal of metal droplets and slag outside the converter and tuyere metallization



R&D Department, Department of R&D Information Support

2, Dniprobudivska str., Kamianske, Ukraine, 51900

e-mail: science@dstu.dp.ua; <http://www.dstu.dp.ua>; Tel./Fax: (0569) 50-63-37



MULTIPURPOSE ROTATING SKULL SHOTCRETE-TUYERE

Purpose of invention

The invention is developed for the final converter slag splashing on the lining of an oxygen converter with the simultaneous addition of slag layers and the change of chemical composition and physical state of the latter by adding solid particles; and for formation of a skull protective layer of high resistance on converter lining as well

Essence of invention

12-nozzle rotating skull tuyere with body and tip gas cooling (2 de Laval nozzles, 10 lateral cylinder nozzles) has been applied. The capability of efficient usage of magnesium-slate and unburnt cheap magnesium-containing gunning mix is provided. The time required for the protective coating application on the lining has been reduced by half

Key benefits of invention

The invention key benefits are the capability to combine the operations of slag skull layer application and converter lining gunning; the capability to gun the lining with cheap, easily available gunning mix, eliminating the fuel factor and reducing environmental load. The specific costs of magnesium-slate mass are reduced by 68%, the operation costs – by 64%, the lining wear rate – by 52%, and the converter lining resistance is increased by 37%

Intellectual property protection status

3 patents of Ukraine have been obtained

Market demand

Converter shops of Ukrainian and foreign metallurgical enterprises can be equipped with such skull shotcrete-tuyeres

Standby status

Industrial prototype has been produced; experimental industrial tests have been performed; and the anticipated characteristics have been confirmed

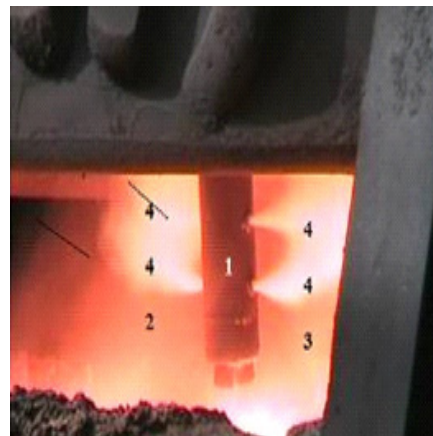

R&D Department, Department of R&D Information Support

2, Dniprobudivska Str., Kamianske, Ukraine, 51900
e-mail: science@dstu.dp.ua; <http://www.dstu.dp.ua> Tel./Fax: (0569) 50-63-37



CONCEPTUALLY NEW THERMOMOLECULAR DAMPERS-DISSIPATORS THROUGH THE EXAMPLE OF CAR SHOCK ABSORBERS

Purpose of invention

The object of development is innovative dissipators of mechanical energy (shock absorbers, anti-vibration systems); dampers of a car suspension, hydraulic system of heavy vehicles (mining dump trucks, skidders, all-terrain tractor units); vibration protection systems; aircraft landing systems; earthquake-resistant constructions

Essense of invention

The thermomolecular damper of a car suspension with V.A. Yeroshenko new heterogeneous working medium is developed: the damper amplitude is ± 84 mm; the operation force on a shock absorber is 1 kN; the shock absorber working frequency range is 1-22 Hz against 4-6 Hz for a conventional hydraulic shock absorber; the required amount of a heterogeneous working medium is 20-25 cm³ alternatively to 1000-1500 cm³ of a technical oil

Key benefits of invention

A shock absorber has high energy density of a dissipation process (5-50 J/cm³); maximum work load may be greater than the one of conventional analogues without the performance loss; passengers comfort and extension of the service life of automobile mechanical parts are provided by virtue of the reduction and stabilization of force in reaction to the perturbation from road barriers; safe road adherence with simultaneous maximum passengers comfort is provided; the force on a vehicle body is applied in a wide speed range and high rate of road barriers occurrence

Intellectual property protection status

Ukrainian and international patents have been obtained

Market Demand

The market demand of the invention is conditioned by its high competitiveness and need for substitution of hydraulic shock absorbers as environmental pollutants in response to advanced ecological standards

Standby status

Laboratory prototype has been produced; technical documentation has been prepared

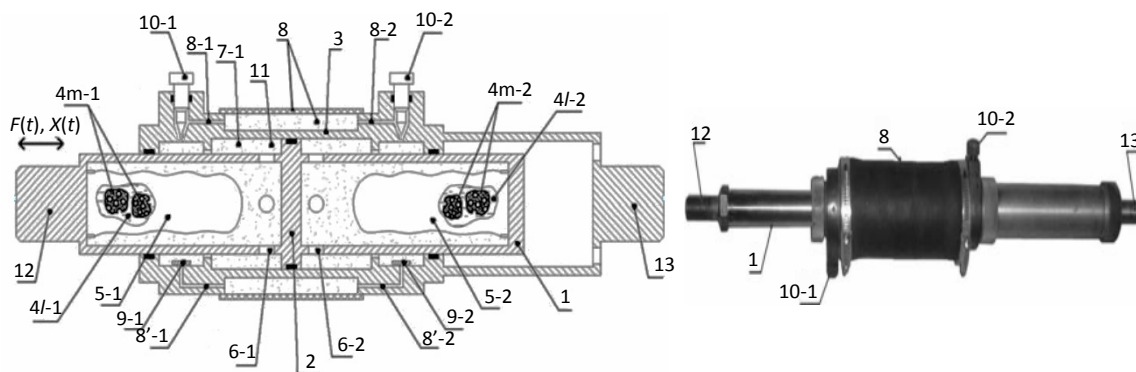

1-rod; 2- piston; 3- cylinder; 4/1, 4/2- working fluid; 4m-1, 4m-2 - porous matrix, 5-1,5-2 – capsules of a heterogeneous working medium, 6-1 ,6-2 ,8-1, 8-2, 8-1`, 8-2`-hydro-channels; 7-1 – working space; 8- balance chamber; 9-1, 9-2 – valves; 10-1, 10-2 – throttles; 11- process fluid; 12, 13 - mounts

Department of Intellectual Property and Commercialization of R&D Products

37, Peremohy ave., Kyiv, 03056, Ukraine

e-mail: komerc.patent@kpi.ua, <http://www.kpi.ua>, Tel./fax: +38(044) 236-40-56



RESOURCE-EFFICIENT TECHNOLOGY OF THE MULTI-SIDED PIPES PRODUCTION

Purpose of invention and sphere of application

The invention is developed to be brought into the metallurgical industry for the production of mould tubes applicable in continuous-casting machines in the form of a square pipe with a cylindrical end. This method may be employed for the manufacturing of products in other industries

Market demand

Marketing research has proved that mould tubes, produced according to this technology, meet the requirements and competition of the market of Ukraine, CIS countries, and western industrially advanced countries. Operational recommendations on the basis of the developed technology are applicable at the "Kryukov Railway Car Building Works" PJSC, "AvtoKrAZ" PJSC, "Transmash" PJSC SPC, "Tungsten" LLC SPC

Intellectual property protection status

4 patents of Ukraine on a utility model have been obtained

Essence of invention

The invention is a production method for copper and copper-alloy mould tubes and multi-sided pipes. The essence of the invention is a technique of pipe production by the pulse action of the explosive materials energy on the primary blank deformation. One of the process aspects is a deformation in a liquid medium (water). This aspect makes it possible to obtain a homogenous deformation and eliminate different wall thickness of the parts after forming. Manufacturing scheme and manufacturing jig have been tested out under production conditions during the forging of mould tubes from a copper seamless drawn pipe with a 16 mm wall. Important characteristics of the process are the capability to forge blanks without additional expenditures and specific conditions, furthermore forging equipment is not necessary anymore

Standby status

Industrial prototypes and techniques have been developed; the process computer model has been designed and optimal parameters of mould tubes production have been set. The industrial prototypes produced have passed adequate laboratory and in-process tests

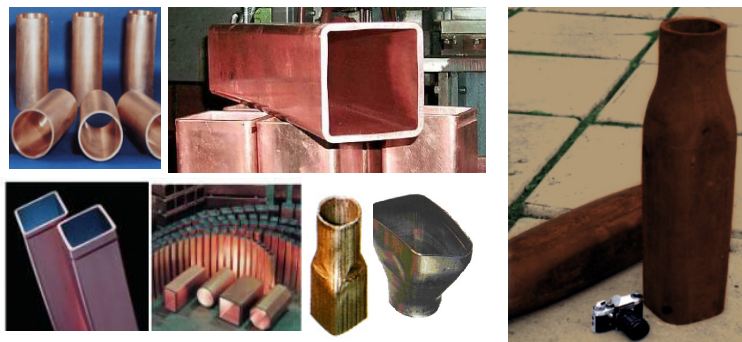

R&D Department

20, Pershotravneva str., Kremenchuk, Ukraine, 39600
e-mail: nich@kdu.edu.ua, <http://www.kdu.edu.ua>; Tel./Fax. +38 (053066) 3-62-17



AUTOMATED REFRIGERATION UNIT PROVIDING POSSIBILITIES FOR RESEARCH AND IMPROVEMENT OF EQUIPMENT ENERGY CHARACTERISTICS

Purpose of invention and sphere of application

The refrigeration unit developed allows for research of the thermodynamic processes occurring in the system and methods of the system operation modes control. The thermal chamber, with which the refrigeration system is equipped, allows carrying out experimental studies in a wide temperature range (-35 ... +50°C)

Intellectual property protection status

4 patents of Ukraine have been obtained

Market demand

Trading networks, catering facilities, food and chemical industry enterprises are interested in automated refrigeration units

Standby status

The operational prototype of the unit capable of operation in both manual and automatic modes has been manufactured. A number of studies with an application of a new refrigerant (R404a) have been carried out

Key benefits of invention

The most important factor of the product is the improvement of the refrigeration unit energy efficiency by virtue of the integrated automation. The level of the refrigeration unit automation allows flexible and prompt control of the system operating temperatures and other equipment operational parameters; it also provides means for handling of alarm signals. The capability of remote control, adjustment of the control algorithm and accumulated data taking off through the Internet is provided



Department of Regulatory and Engineering Provisions and Metrology

112, Kanatna str., Odesa, Ukraine, 65039,

e-mail: nauka@onaft.edu.ua, www.udhtu.edu.ua; Tel./Fax. +38 (048) 712-41-30, +38 (048) 724-28-75



TRIBOTECHNOLOGY OF THE WEAR-RESISTANCE INCREASE OF FRICTION JOINTS OF MACHINES AND MECHANISMS

Purpose of invention and sphere of application

A number of innovative design, machining, material science and rheological advanced technologies of the wear-resistance and efficiency increase of friction joints have been developed on the basis of an invented adhesive deformation friction model. These technologies may be applied in design offices with further implementation to the mass production of aerospace, automotive and other industries of the Ukrainian mechanical engineering complex

Market demand

Practically all enterprises of the Ukrainian mechanical engineering complex require extension of the equipment overhaul life

Key benefits of invention

The most important factors of the invention are the increase in wear-resistance and service performance of the equipment that determine the overhaul time of both separate friction joints and product as a whole. Laboratory-benchmark and performance tests have proven the possibility to increase the capability of the highload tribosystems of aircraft gas turbine engines by 7 times due to advanced tribotechnologies application. Due to prevention of the conditioning for occurrence of the adhesion contact between friction surface and its molecular force, the energy consumption to cope with friction force, vibration, noise and other operation harmful factors have been reduced

Standby status

Laboratory-benchmark and performance tests of the different techniques efficiency both separately in conjunction with design and machining, material science and rheological technologies using developed innovative testing-measuring equipment are still being performed

Intellectual property protection status

11 patents of Ukraine on a utility model, 4 patents of Ukraine on the invention, 2 patents of Germany and 3 patents of the Russian Federation have been obtained; 2 PCT patent applications have been obtained

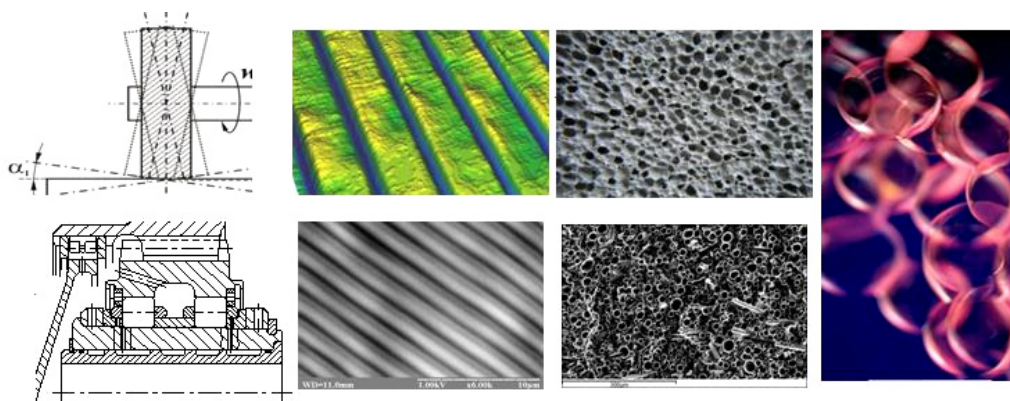

Diagrams and photos of design, machining, material science and rheological technologies (from left to right)

Department of Scientific and Technical Information

1, Kosmonavta Komarova ave., Kyiv, Ukraine, 03058

e-mail: vtnik@nau.edu.ua, <http://nau.edu.ua/> Tel.: (044) 406-71-56, Fax: (044) 406-79-21



UNPOLARIZED METAL-OXIDE REFERENCE ELECTRODE

Purpose of invention and sphere of application

Potential users of the indicator electrode (reference electrode) are gas and oil industry enterprises as well as public utility providers. This electrode is designed to be applied in the systems of electrochemical measurements of electrode potentials in underground constructions and thermal public water systems to provide corrosion protection, efficient monitoring and stability of operation of such installations

Essense of invention

The oscillation of the potential in the range of pH 3-10 is 0.01-0.05 V in the solutions of acids, alkalies, salts (sulfates, chlorides) and mixtures

Key benefits of invention

The main benefit of a metal-oxide reference electrode against its closest analogue and other conventional reference electrodes is the increase in an operational life and electrode potential stability by virtue of its reversibility with OH' anions. Another benefit of the electrode is an improvement of the technology of obtaining the potential-determining metal oxide electrode due to the elimination of energy-consuming processes. Developed metal-oxide electrode is universal as it may be applicable in a wide variety of solutions; this factor significantly extends its field of application

Intellectual property protection status

The patent of Ukraine on the invention has been obtained

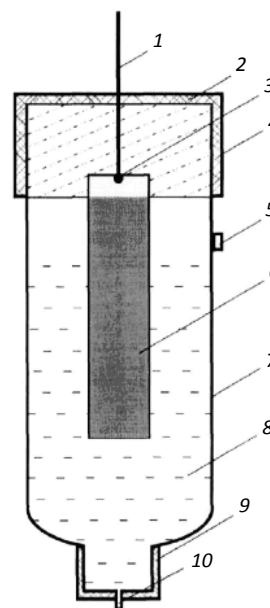

Schematic image of a metal-oxide reference electrode

- 1 – terminal;
- 2 - electrode cover;
- 3 - welding point;
- 4 - insulating cap;
- 5 - electrolyte supply hole;
- 6 - potential-determining electrode based on niobium;
- 7 - electrolytic cell;
- 8 - matrix electrolyte;
- 9 - sealing cover;
- 10 - electrolytic bridge

Market demand

The electrode may be the part of electrochemical measurement systems at petroleum industry and public services enterprises

Standby status

The experimental prototypes of electrodes have been produced; their characteristics have been proven

R&D Department

2, Kyrpychova str., Kharkiv, 61002, Ukraine
 e-mail: nti@kpi.kharkov.ua, <http://www.kpi.kharkov.ua>, Tel /fax: +38(057) 707-62-13



MULTIFUNCTIONAL THREE-PHASE SEPARATOR FOR OIL TREATMENT UNIT

Purpose of invention

The three-phase separator is designed for oil treatment; it constructively connects electrical dehydrator and oil heating and separation

Key benefits of invention

The three-phase separator is characterized by multifunctional performance and versatility, high anticipated separation efficiency in a wide variation range of efficiency, pressure temperature and water cut in oil-and-water emulsion. Anticipated payback period of new separators and electrical dehydrators is up to 3 years, and in case of the remodeling of existing separation equipment, it doesn't exceed 1.5 year

Market demand

The invention may be applicable in oil treatment units

Standby status

The invention has been implemented at industrial enterprises

Essence of invention

The three-phase separator is a horizontal oil-gas-water separator with inbuilt tubular fired heater for crude oil heating and degasification which is additionally equipped with electrostatic coalescence sections, louvered set of nozzles, mash baffle and mist eliminator, vortex gas and water separator. Exclusively associated petroleum gas, which evolves from the unit during the oil degasification, is used as a fuel gas while in operation

Intellectual property protection status

15 patents of Ukraine on a utility model and the inventions have been obtained

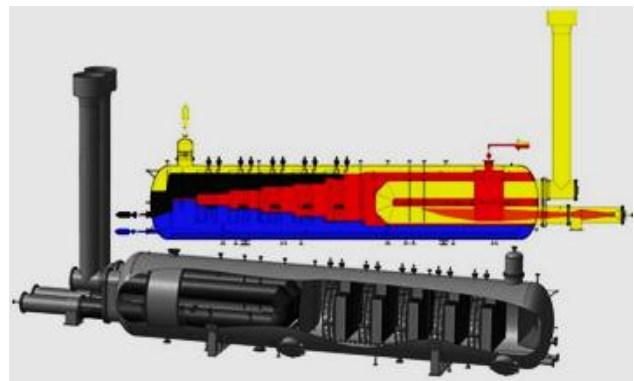

R&D Department, Centre of Scientific, Technical and Economic Information

2, Rymkoho-Korsakova str., Sumy, 40007, Ukraine

e-mail: dkurbatov@sumdu.edu.ua, info@cni.sumdu.edu.ua, Tel./fax: +38 (0542)



GAS SEPARATOR OF INERTIAL FILTERING TYPE

Purpose and sphere of application

Conventional for gas separation equipment used in chemical production processing train is characterized by the low degree of separation (efficiency does not exceeds 70%, sometimes it reaches only 15-30%). Improvement of the efficiency of gas separators, manufactured by state or industry standards, is possible due to the application of new gas-liquid flow treatment techniques and installation of high-efficient inertial filtering separators with separation efficiency up to 99.5%

Essence of invention

Combination gas separators (inertial filtering type) are equipped with efficient inlet diverters, performing functions of preliminary liquid separation and mechanical impurities trapping; as well as fine aerosol coalescers and high-efficient centrifugal, inertial and filtering separation units

Intellectual property protection status

15 patents of Ukraine on utility model and the invention have been obtained

Market demand

The invention may be applied in oil and gas treatment units and chemical production, in which gas-liquid flow separation is required

Standby status

The invention has been implemented at industrial enterprises

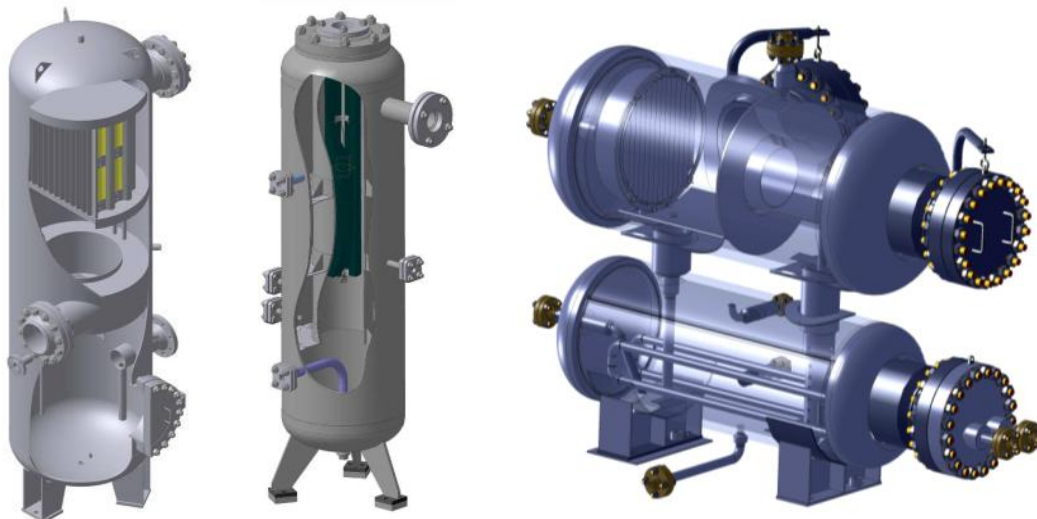

R&D Department, Centre of Scientific, Technical and Economic Information

2, Rymkoho-Korsakova str., Sumy, 40007, Ukraine

e-mail: dkurbatov@sumdu.edu.ua, info@cnti.sumdu.edu.ua, Tel./fax: +38 (0542)



RECYCLING UNITS FOR NOBLE GASES REUSE IN KNOWLEDGE-INTENSIVE INDUSTRIES

Purpose of invention

With the shortage of such noble gases as xenon or krypton the demand for them may be partially satisfied by the recycling or reuse

Intellectual property protection status

2 patents of Ukraine have been obtained

Market demand

Automatic units for krypton and xenon storing are the object of interest for foreign enterprises, in particular for those, specializing in the electronic components production

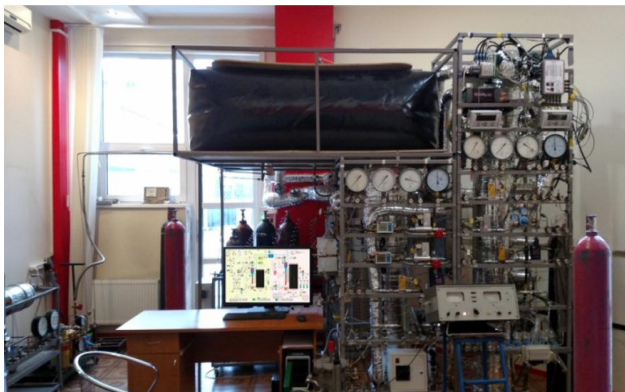

Essence of invention

The equipment system collects noble-gas mixtures, produced as a result of their consumption in medicine, space technology, electronic and lighting industries. Minor components of the mixture are extracted from it, and the target product (krypton or xenon) is purified to its original state by virtue of multi-stage separation in cryogenic environment.

Purity of the product: 99.999%.

Input mixture stream capacity: 1-1.5 normal m³ per hour.

Target product loss: < 1 %.

Type of refrigerant: liquid nitrogen (T = 84 K; P = 2 bar (abs.)).

Refrigerant loss in a steady mode: 6-10 kg per hour

Dimensions: 2.8 x 3.0 x 2.8 m.

Energy consumption: 1 kW.

The low-temperature unit is fully automated. The possibility of remote control, adjustment of the control algorithm and accumulated data taking off through the Internet is provided

Standby status

The operational prototype of the installation capable of operation in both manual and automatic modes has been manufactured. A number of tests with simulation mixtures have been conducted. The tests have been followed by gas analysis of received fractions

Department of Regulatory and Engineering Provisions and Metrology

112, Kanatna str., Odesa, Ukraine, 65039,

e-mail:nauka@onaft.edu.ua, www.udhtu.edu.ua Tel./Fax. +38 (048) 712-41-30, +38 (048) 724-28-75



BEARING QUALITY CONTROL SYSTEM QCS-01

Purpose of invention and sphere of application

The device is designed for the quality control of ball bearings by their vibration characteristics and runout factor. All mass and maintenance production enterprises of the Ukrainian mechanical engineering complex are in urgent need of such systems

Essence of invention

The efficiency of QCS-01 is up to 30 ball bearings per hour depending on a research objective and extent of a test. The control system is automated and allows repeated online monitoring of the bearing state by virtue of special software. The stand allows bearing control in a wide size range and state assessment by vibration acceleration and runout time. It is possible to perform runtime comparative spectrum analysis of primary signals

Intellectual property protection status

2 patents of Ukraine on a utility model have been obtained. The patent on the invention is undergoing an examination at "Ukrainian Intellectual Property Institute"(Ukrpatent)

Key benefits of invention

QCS-01 system differs fundamentally from the existing analogues by innovative method of bearing state assessment by virtue of its contactless rotation and contactless axle and radial load through electromagnetic inducers and electromagnetic devices; this allows avoiding defects of all existing vibration diagnostic systems, particularly of their contact rotation technique always contributing random vibration component and leading to errors

Market demand

The market sector of the invention is engineering offices, mass and maintenance production of the Ukrainian mechanical engineering complex (aerospace, engineering and other industries)

Standby status

Service models of the unit have been extensively tested at three enterprises demonstrating their high efficiency. The design documentation is still under development and should be refined considering customization



Department of Scientific and Technical Information

1, Kosmonavta Komarova ave., Kyiv, Ukraine, 03058

e-mail: vtnik@nau.edu.ua, <http://nau.edu.ua/> Tel.: (044) 406-71-56, Fax: (044) 406-79-21



MAGNETIC PULSE SYSTEM FOR METALWORKING

Purpose of invention and sphere of application

The system developed finds wide application in different manufacturing industries: in branches of the vehicle manufacturing industry; automotive engineering, aircraft engineering, ship construction; in the auto or aircraft body repair industry without taking a vehicle apart and destroying protective lacquer coating; in mechanical engineering when production process requires product processing to be performed only on one side, also in the case of non-metal and metal pipes jointing, crimping electrical wires; printed circuit board forming

Intellectual property protection status

More than 20 patents of Ukraine have been obtained

Market demand

The invention is in-demand by machining and maintenance industries in Ukraine and abroad

Essence of invention

The essence of the invention is the electromagnetic field effect on a blank without a mechanical contact. Depending on the signal applied to a tool, blank attraction or repulsion occurs.

System performance specifications: stored power is approximately 2 kJ; supply voltage is 380/220 W; charge voltage of capacitive storages is 100-2100W; discharge impulse frequency factor is approximately 1-10 Hz; switch type is a thyristor key; operational conditions are aperiodic; oscillatory

Standby status

The experimental prototype of the invention has been produced; functional diagrams have been optimized; anticipated characteristics have been proven



Department of Intellectual Property

25, Yaroslava Mudroho str., Kharkiv, Ukraine, 61002

e-mail: intellect@khadi.kharkov.ua, <http://khadi.kharkov.u/> Tel.: +38(057) 707-36-70



INDUCTION HEATING DEVICE FOR MAINTENANCE TECHNOLOGIES

Purpose of invention and sphere of application

The device is intended for metal ferromagnet surfaces, elements and components heating and may be used in the motor transport service and maintenance as well as in the fields where local heating of metal objects is necessary. The potential users are service stations

Essence of invention

The device operation is based on heating with Foucault eddy currents induced in the body of the heated object.

Operating voltage range: 190-240 V.

Instrument voltage: 35 V.

Output power: 0.2 ... 2 kW.

Power source weight: 2 kg.

Instrument weight: 1.5 kg

Intellectual property protection status

5 patents of Ukraine have been obtained

Market demand

The device is in demand mostly on the market of services offered by vehicles service stations. Besides, the device can be used in any operations where heating of metal components or structural constituents of particular equipment or mechanism are required

Standby status

A prototype has been manufactured, conceptual schemes have been well-proven, expected characteristics have been confirmed.



Department of Intellectual Property

25, Yaroslava Mudroho str., Kharkiv, Ukraine, 61002

e-mail: intellect@khadi.kharkov.ua, <http://khadi.kharkov.u/> Tel.: +38(057) 707-36-70



MULTI-CYLINDER ENGINE POWER SUPPLY SYSTEM

Purpose of invention and sphere of application

The power supply system with cylinder bank tripping power is used for installation on a multi-cylinder engine with petrol injection with power supply from the 12 V on-board system and aims at increased fuel efficiency. Cylinder disconnection system does not affect working conditions of the engine power management and ignition processor and is intended for use in cars being in operation. The cylinders are disconnected without changing the engine gas interchange parameters. Potential users of this system are vehicular transport and engine manufacturing enterprises

Market demand

Such power supply system may be used on the engines of cars in operation

Intellectual property protection status

6 patents of Ukraine on the utility model and 2 certificates of copyright registration have been obtained

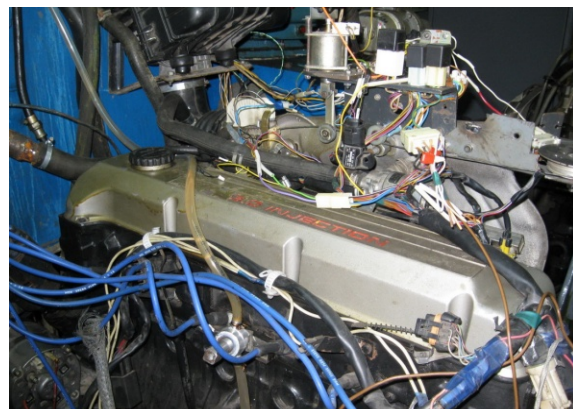
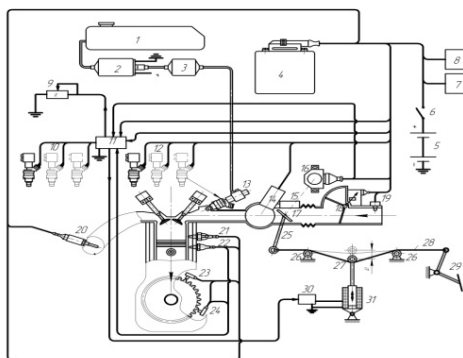

Key benefits of invention

It is established that while the half of the cylinders are disconnected, the fuel efficiency of the petrol engine 6CH 9.5 / 6.98 in the load range up to 60 Nm is improved by an average of 15%. Engine tests in operating modes (unstable modes or acceleration, deceleration) allow an increase in fuel efficiency by 8.05%. At idle, fuel economy averages 22.86%. When using the catalyst converter, the total overall emissions of harmful agents narrowed to CO remain virtually unchanged when the engine is running on half of the cylinders, and in some modes slightly decreased

Standby status

An experimental sample has been made which is in working condition, cylinder deactivation process parameters have been determined, a mathematical model has been developed, the adequacy of which has been confirmed experimentally

Technology Transfer, Innovation Activity and Intellectual Property Department

1, M. Omelianovycha-Pavlenka str., Kyiv, Ukraine, 02000
e-mail: ntt@i.ua, <http://www.ntu.edu.ua>, Tel. / fax: +38 (044) 288-71 -01



HIGH-EFFICIENCY SCREW PUMP

Purpose of invention and sphere of application

The screw pump is designed to lift liquids to a small height (2-8 m). Potential users can be water supply and water disposal enterprises, meliorative enterprises, as well as enterprises of any industry where there is a need to lift liquids to a small height

Intellectual property protection status

1 patent of Ukraine has been obtained

Essence of invention

The new design instead of an open screw on two support bearings contains a screw with a central shaft and helical helicoidal blades placed in a cylindrical body and rigidly connected to it without gaps (forming a rotor/body assembly). Along with the drive, it is mounted on the mobile inclined part of the frame on the support rollers. The lower part of the rotor body is immersed in the liquid so as to freely enter the spiral hole and to fill the first section of the interblade spaces. During rotation, the liquid is moved through a spiral channel in the upward direction. Due to the absence of gaps between the blades and the cylindrical body there is no flow of the liquid in the reverse direction. This in turn increases the efficiency of the device

Market demand

Such pumps can be used by all enterprises of the water supply and sewerage system of Ukraine

Standby status

A demonstration model of a screw pump has been manufactured



Department of Scientific and Technical Information

1, Kosmonavta Komarova ave., Kyiv, Ukraine, 03058

e-mail: vtnik@nau.edu.ua, <http://nau.edu.ua/> Tel.: (044) 406-71-56, Fax: (044) 406-79-21



COUNTERBALANCE VALVE

Purpose of invention and sphere of application

The counterbalance valve combines the functionality of the hydraulic lock and the brake valve. The hydraulic device is designed to stabilize the speed of the hydraulic engine, fix the hydraulic engine under the action of the load with minimal leakage and to reduce the energy losses in the hydraulic drive of the mobile working machine. The counterbalance valve is recommended to be installed in the hydraulic drive control systems of loaders, excavators, manipulators and other hydroficated mobile working machines. The application sphere of such mobile working machines covers the agricultural, construction, mining industries

Market demand

Counterbalance valves may be installed in hydraulic control systems of domestic and foreign mobile working machines

Standby status

A schematic diagram has been developed, an experimental sample has been made, the expected characteristics have been confirmed, and design documentation has been developed

Essence of invention

The developed hydraulic device is designed for a maximum pressure of 20 MPa and a nominal flow rate of 60 l/min. The counterbalance valve ensures the degree of tightness of the working hydraulic lines at a level of 3-5 drops per minute. For the hydraulic drive control system with the counterbalance valve, the inaccuracy in stabilizing the speed of movement is 6%. The control pressure of the counterbalance valve is 1.5-3 MPa

Intellectual property protection status

1 patent of Ukraine on the utility model has been obtained

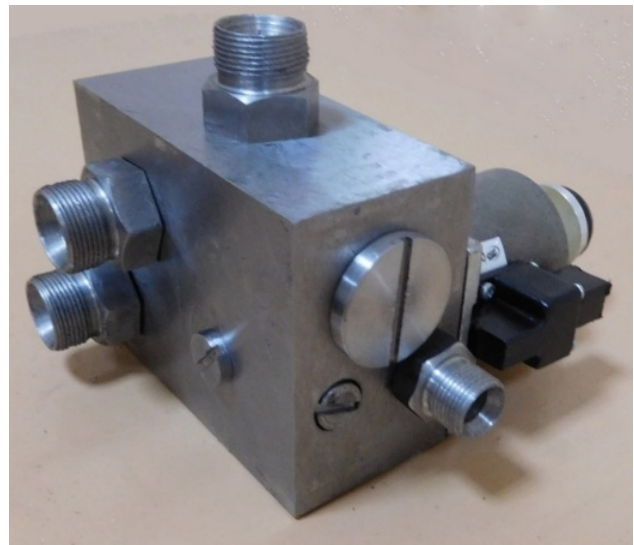

Department of Intellectual Property

95, Khmelnytske Shose str., Vinnytsia, 21021, Ukraine
e-mail: vntu@vntu.edu.ua, <http://vntu.edu.ua/>, Tel: +38(0432) 56-08-48, fax: +38(0432) 46-57-72



STOP BLOCKS FOR WHEELED VEHICLES

Purpose of invention and sphere of application

Stop blocks are designed to hold automobile and wheeled tractor equipment with a gross weight of up to 350 tons at standstill on roads with an angular position of up to 12%. Potential users of the stop blocks are motor transport enterprises taking advantage of trucks and buses with a gross mass of up to 36 tons, mining enterprises that take advantage of heavy-duty dump trucks and wheeled tractor machinery weighing up to 350 tons

Intellectual property protection status

1 patent of Ukraine has been obtained

Market demand

Trucks, buses and wheeled tractor machinery of motor transport enterprises and transport departments of mining enterprises of Ukraine may be equipped with stop blocks

Standby status

Stop blocks have been tested experimentally and have been implemented at transport departments of Ukrainian mining enterprises

Essence of invention

The model KUA 8-25 is designed for working with trucks, buses and wheeled tractors with a wheel diameter of up to 1200 mm and weighing up to 36 tons. The model KUA 30-55 is designed for working with heavy-duty dump trucks and wheeled tractor machinery with wheel diameter from 1500 to 2800 mm and weighing up to 200 tons.

The model KUA 90-185 is designed for working with heavy-duty dump trucks and wheeled tractors with a wheel diameter from 2600 to 3600 mm and weighing up to 350 tons



R&D Department

20, Pershotravneva Str., Kremenchuk, Ukraine, 39600
e-mail: nich@kdu.edu.ua, <http://www.kdu.edu.ua> Tel./Fax. +38 (053066) 3-62-17

7. Instrument engineering

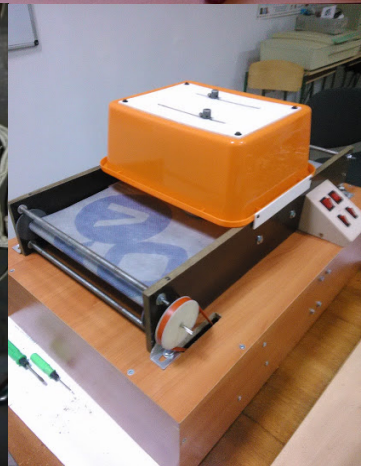
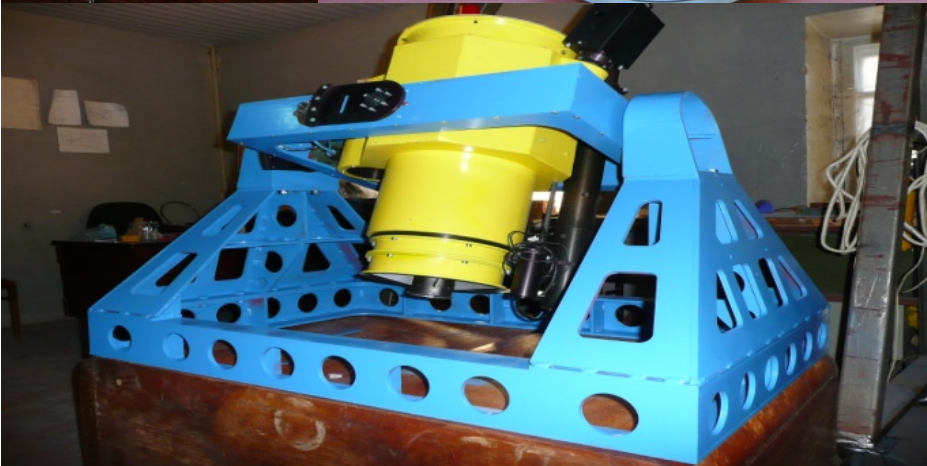



NANOSATELLITE POLYITAN-2-SAU OF IGOR SIKORSKY KPI IN THE INTERNATIONAL PROJECT QB50

Purpose of invention and sphere of application

The invention concerns the fulfillment of scientific problems of studying the composition and state of the lower layers of the ionosphere and the thermosphere, in particular, the study of atomic and molecular oxygen in their composition, and the refinement of the global ion-thermospheric model of the atmosphere

Essence of invention

Weight: 1.98 kg.
Overall dimensions of the nanosatellite:
– working state: 110x100x227 mm;
– transport position: 675x375x227 mm.
Average power of solar batteries:
not less than 2.4 W.
Battery capacity: 22 W × h.
Maximum short-term energy consumption: 8.2 watts.
Average daily satellite consumption (excluding FIPEX): 0.5 W.
Maximum data transfer per day: 0.3 MB.
The height of the solar synchronous orbit above the sea level: 412-90 km.
Duration of the mission: 2 years

Intellectual property protection status

3 patents of Ukraine have been obtained

Key benefits of invention

The possibility of obtaining valuable orbital telemetry information.
High positioning accuracy using GPS / GLONASS.
Creation of a complete equipment set (satellite + ground earth station). Scalability of the satellite platform in accordance with the Cubesat standard.
High computational performance and low power consumption

Market demand

The invention may be useful for enterprises and institutions of various forms of ownership in such industries as space, emergency situations, meteorology, ecology, agriculture and the like

Standby status

The R&D project has been completed. The technology has passed laboratory and industrial testing

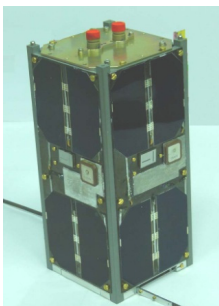

Department of Intellectual Property and Commercialization of R&D Products

37 Peremohy ave., Kyiv, 03056, Ukraine
e-mail: komerc.patent@kpi.ua, <http://www.kpi.ua>, Tel./fax: +38(044) 236-40-56



SATELLITE TELESCOPE OF ELECTRONS AND PROTONS "STEP-F"

Purpose of invention

The satellite spectrometer, a telescope of high-energy charged particles STEP-F, is designed for measuring spatio-temporal distributions of high-energy charged particle fluxes in near-Earth space at satellite altitudes

Intellectual property protection status

Intellectual property rights have not been protected

Standby status

In 2009, the STEP-F instrument was launched into outer space in a circular orbit as part of the CORONAS-PHOTON spacecraft

Essense of invention

The instrument was designed and manufactured by order of the State Space Agency of Ukraine, passed all types of tests at the enterprises of the space industry. It consists of a block of the STEP-FD detectors, installed in the open space on the platform of the spacecraft, and the STEP-FE electronics module located in the hermetically sealed compartment of the satellite. The STEP-F instrument registers electrons with energies of 0.2-3 MeV, protons with energies of 3.7-60 MeV, and particles with energies of 16-180 MeV. Weight – 17 kg; overall dimensions: STEP-FD – 337x395x293 mm, STEP-FE – 95x287x160 mm; power consumption – 48 W. The instrument is used in the space industry on the scientific satellite board

Market demand

The invention is in demand for space research



Innovation Centre

6, Svobody sq., Kharkiv, Ukraine, 61022.

e-mail: innovation@karazin.ua, <http://innovation.karazin.ua>, Tel./fax: +38(057) 705-52-89



HARDWARE AND SOFTWARE FACILITIES OF INTEGRATED INERTIAL AND SATELLITE NAVIGATION SYSTEM FOR UNMANNED AERIAL VEHICLES

Purpose of invention

The integrated inertial and satellite navigation system (IISNS) is designed to determine the navigational parameters of a mobile object. The core of the IISNS is the platformless inertial navigation unit (PINU), assembled on a micro-electro-mechanical accelerometers and gyroscopes. PINU is integrated (located on one board) with a satellite navigation receiver, magnetometer and barometric altimeter. Allows: prediction of the admissibility of signals of optimal configurations of navigation systems GPS and GLONASS; assessment of the deterioration factor in the accuracy of navigation definitions; calculation of the coordinates, speed and time of the consumer according to GPS and GLONASS signals

Intellectual property protection status

4 patents and 2 copyright certificates have been obtained

Market demand

The developed IISNS may be installed on unmanned aerial vehicles of various types of production in Ukraine and other countries

Essence of invention

The developed IISNS is able to determine: the angular velocity with an accuracy of $0.16^\circ/\text{s}$; vehicle acceleration 1.5 mg ; height with an accuracy of 3 m ; angles – bank and pitch angles with an accuracy of 1° , the course with an accuracy of 2° , the speed with an accuracy of 0.1 m/s . The coordinates of the aircraft are determined by the IISNS with an accuracy of 5 m . The IISNS enables: the determination of the object angular velocity in the range of $\pm 450^\circ/\text{s}$; the determination of the object acceleration in the range of $\pm 18 \pm 10 \text{ g}$; the determination of flight altitude in the range from 0 to 3500 m ; the determination of aircraft angles – bank angle in the range of $\pm 180^\circ$, pitch angle – $\pm 90^\circ$, course from 0° to 360° ; the determination of the speed of an unmanned aerial vehicle in the range from 0 to 400 m/s . These indicators correspond to the indices of the IISNS of the well-known company SGS (France).

Standby status

The experimental sample has been manufactured, the software has been created, the expected characteristics have been confirmed

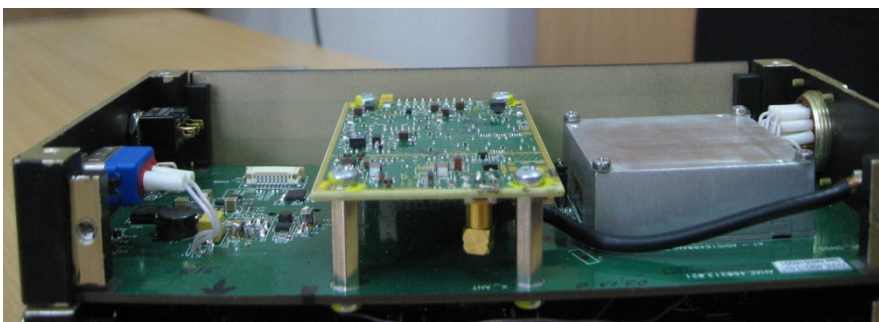

Model of the inertial-satellite navigation system of unmanned aerial vehicle

Department of Scientific and Technical Information

1, Kosmonavta Komarova ave., Kyiv, Ukraine, 03058

e-mail: vtnik@nau.edu.ua, <http://nau.edu.ua/> Tel.: (044) 406-71-56, Fax: (044) 406-79-21



FORWARD FLOW SENSOR IN THE SYSTEM FOR DEORBITING SPACE OBJECTS FROM LOW NEAR-EARTH ORBITS

Purpose of invention

The sensor of the forward flow allows to determine the angular position of the deorbit system at the initial atmospheric part of the descent trajectory with its subsequent stabilization, thus ensuring the endurance of the trajectory and spatial orientation of the system when entering the dense layers of the atmosphere. The proposed technical solution can be used to create promising space systems for cleaning the near-Earth environment

Essense of invention

The sensor is based on a new measurement principle in the coordinate system associated with the moving plane of the spatial angle of attack and synchronization of spatial rotational movements. Instead of traditional angles of attack and bank, the spatial angle of attack and the aerodynamic angle of bank are measured. The way to stabilize the deorbit system and the space object is easy to implement and does not require significant costs. Number of measuring channels is at least 3: measurement of the spatial angle of attack, the angle of bank, the channel for measuring the difference in the total and static pressure. The range of measurements of the spatial angle of attack is at least 140° , of aerodynamic angle of bank from 0° to 360° . The sensor provides sufficient accuracy of measurements, has a simple design, low weight and overall dimensions, which are minimized, based on the tactical and technical characteristics of the deorbit systems used

Intellectual property protection status

5 patents of Ukraine have been obtained

Market demand

Measuring complexes of unmanned research and experimental aircrafts with increased maneuverability may be equipped with such sensors

Standby status

The schematic diagram has been well-proven and the model of the sensor tested in a wind tunnel has been manufactured

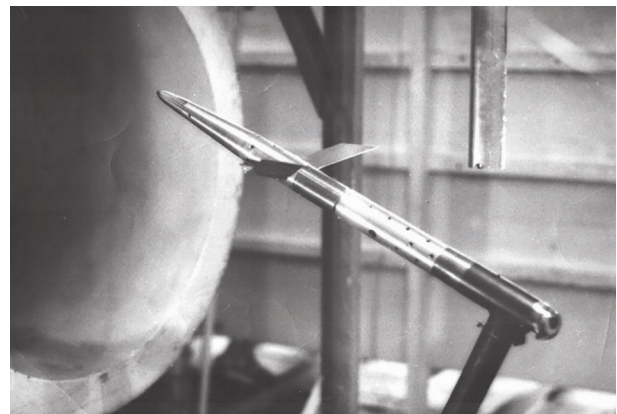

Model of the aerodynamic testing sensor

Department of Scientific and Technical Information

72, Haharina ave., Dnipro, Ukraine, 49010

e-mail: onti_dnu@i.ua, <http://www.dnu.dp.ua>, Tel.: +38(056) 760-93-54



COMPLEX GAS-AEROSOL POLARIZATION HOLOGRAPHIC LIDAR

Purpose of invention

The instrument is designed for remote monitoring of the atmosphere

Intellectual property protection status

The patent of Ukraine and 2 patents of the Russian Federation have been obtained

Market demand

The invention is in demand on the market of Ukraine

Standby status

A prototype has been created

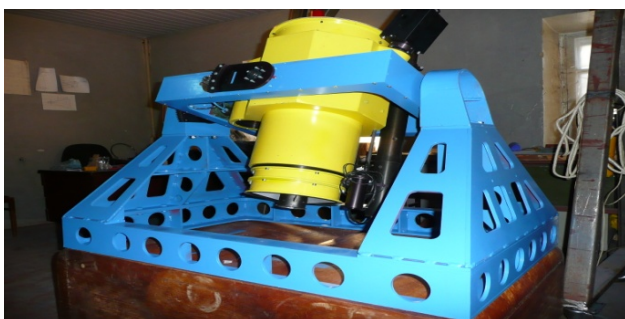

Essence of invention

The holographic lidar is developed as a complex instrument, which allows studying simultaneously the gas and aerosol composition of the atmosphere. The application of the spontaneous Raman scattering method to the lidar makes it possible to obtain values of atmospheric gas concentrations with a high spatial resolution almost instantaneously, which provides determination of high-precision and operative sources of gas contamination in difficult conditions of environmentally unfriendly industrial zones. The aerosol component is studied by an original technique through remote recording of polarization holograms of atmospheric sections. This makes it possible to obtain information on the concentration of aerosols due to the direct study of aerosol particle images, which, unlike other methods, does not require the use of a priori assumptions about the type of aerosol to be investigated and, therefore, avoids the errors associated with it. Thus, the complex gas-aerosol polarization holographic lidar is currently the most promising mean for complete remote monitoring of the air environment and can be successfully used for environmental purposes

Innovation Centre

6, Svobody sq., Kharkiv, Ukraine, 61022.

e-mail: innovation@karazin.ua, <http://innovation.karazin.ua>, Tel./fax: +38(057) 705-52-89



THUNDERSTORM WARNING SYSTEM

Purpose of invention

The system is designed to alert operational personnel of strategic facilities, military units, recreation camps and private individuals about the high occasion of lightning in their location

Essence of invention

A warning of a lightning hazard occurs 10-15 minutes before the occurrence of a lightning strike in a particular location with a probability of more than 90%. The warning system for thunderstorm hazards is based on the concept of monitoring of the intensity of the electric field of the atmosphere with the use of sensors operating under the effect of corona current from metal rods.

Intellectual property protection status

The computer model for calculating the distribution probability of the lightning strike into the elements of the object is protected with a certificate of copyright for the work

Key benefits of invention

Compared to the existing samples of the of the electric field strength indicators in the world, the advantage of the developed system is that the efficiency of the sensor does not depend on the presence of wind, rain and fluctuations in atmospheric pressure. The sensor does not contain any elements that move or simulate the movement of electrodes. As a result, the energy consumption level is lower than that of analogues. Therefore, the operating time in the autonomous mode (when battery-operated) exceeds the duration of the thunderstorm period. The cost of the sensor and warning system is several times lower than that of analogues

Market demand

The system corresponds to the modern world trend. This is confirmed by the new specialized standard IEC 62793:2016 Protection against lightning - Thunderstorm warning systems. Particularly wide application may be obtained by an autonomous electric field intensity sensor for the equipment of small vessels (boats, yachts, etc.)

Standby status

Experimental samples have been developed, which are currently ready for test operation

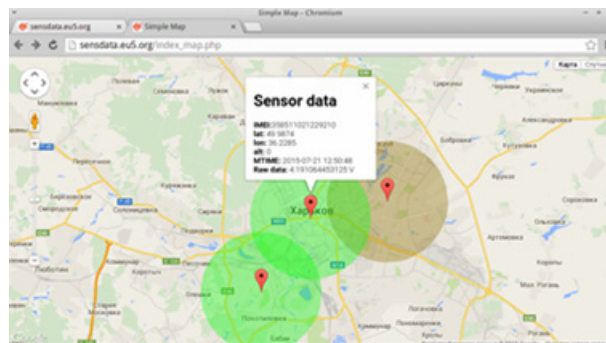

An electronic unit of the electric field strength tensile sensor and an example of a forecast on the terrain

R&D Department

2, Kyrpychova str., Kharkiv, 61002, Ukraine
e-mail: nti@kpi.kharkov.ua, <http://www.kpi.kharkov.ua>, Tel /fax: +38(057) 707-62-13



DIGITAL HOLOGRAPHIC INTERFERENCE MICROSCOPE

Purpose of invention and sphere of application

The invention is intended for obtaining three-dimensional images of phase microobjects and conducting quantitative measurements. Potential users can be medical institutions and institutions of the Ministries of Health Care of Ukraine and Russia, as well as industrial enterprises that produce optical elements with a thin transparent coating

Essence of invention

A digital holographic interference microscope (DHIM) enables to investigate native biological microobjects without special processing. This unique instrument is an indispensable tool in the study of the three-dimensional form of red blood cells, which determines their functional capabilities and can serve as an indicator of the general state of the human body

Comparison with world analogues, key benefits of invention

There are no world analogues of the invention

Intellectual property protection status

The certificate of the State Ukrainian Agency of Copyright and Related Rights has been obtained

Market demand

DHIM can be successfully used in biology and medicine to diagnose blood diseases and for express diagnostics of the general condition of the body. DHIM has also been successfully applied in engineering to study the surface quality of thin films: measuring their thickness and geometric parameters of defects. The invention is in demand in the markets of Ukraine, Russia

Standby status

An experimental prototype has been created

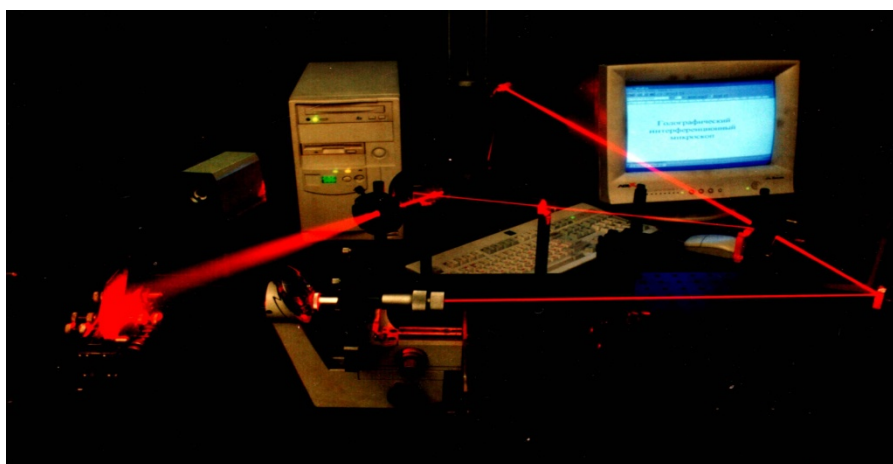

Innovation Centre

6, Svobody sq., Kharkiv, Ukraine, 61022.

e-mail: innovation@karazin.ua, <http://innovation.karazin.ua>, Tel./fax: +38(057) 705-52-89



NON-CONTACT OPTICAL THREE-DIMENSIONAL PROFILOMETER

Purpose of invention

The profilometer is designed for visualization of surface topography with nanometer resolution and subsequent calculation of surface roughness parameters in accordance with the international standard ISO 25178: Geometric Product Specifications (GPS) – Surface texture: Areal

Essence of invention

Scanning field (X, Y): 1500x1800 μm .

Maximum relief height measured (Z):
80 μm .

Vertical resolution (Z): 5 nm.

Scanning time: 0.1-2 min.

Camera resolution: 1.3 mp.

The software is compatible with a PC class computer and works with the Windows XP, 7 operating systems.

The instrument allows building two- and three-dimensional images of the surface, quantify the characteristics of the surface, observe interference patterns in both white and monochromatic light



Intellectual property protection status

1 patent on utility model has been obtained

Market demand

The profilometer may be used at production sites to control the surface quality and critical dimensions of finished products, to control and optimize the production process of optical components, fiber-optic connections, MEMS devices, artificial joints, microelectronics, machine and aircraft components

Standby status

A prototype has been produced, a scanning technique and software have been developed, and a series of studies have been carried out in various fields of science to confirm the capabilities of the instrument

Department of Scientific and Technical Information

1, Kosmonavta Komarova ave., Kyiv, Ukraine, 03058

e-mail: vtник@nau.edu.ua, http://nau.edu.ua/ Tel.: (044) 406-71-56, Fax: (044) 406-79-21



FRICITION AND WEAR TESTING MACHINE ASK-01

Purpose of invention and sphere of application

The developed instrument is intended for tribotechnical tests of structural and combustive and lubricating materials and additives to them due to original multistage methods. The instrument is widely used in the oil refining and mechanical engineering industries, especially in the development and creation of high-performance lubricants and additives to them, as well as power-generating units

Key benefits of invention

The instrument provides a stable contact regardless of the accuracy of model samples manufacturing and allows creating initial contact voltages by Hertz up to 5000 MPa. The ASK-01 friction machine has high reproducibility of the test results of the anti-wear and antifricition characteristics of tribosystems, considering the formation of secondary structures on the working surfaces, and also provides the possibility of regulating and controlling radial deviations within certain limits, which enables to model the conditions of real friction units in laboratory conditions. Three degrees of linear contact freedom during friction of a flat sample with counter sample of a cylindrical shape ensure a correct measurement of the frictional force, without disturbing the contact when the sensor element is deflected, that is the principal novelty of ASK-01

Intellectual property protection status

1 patent of the Russian Federation on the invention and 1 patent of Ukraine on the utility model have been obtained

Market demand

The consumer market sector of the friction machine ASK-01 includes 25 metrology centers in Ukraine, dozens of design offices, dozens of enterprises – manufacturers of lubricants

Standby status

An experimental sample has been produced, the methods have been well-proven, metrological parameters have been experimentally realised

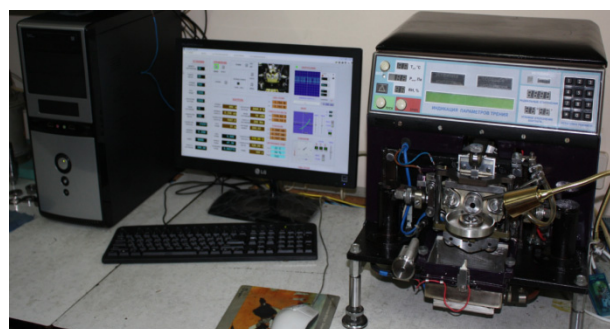

Department of Scientific and Technical Information

1, Kosmonavta Komarova ave., Kyiv, Ukraine, 03058

e-mail: vtник@nau.edu.ua, <http://nau.edu.ua/> Tel.: (044) 406-71-56, Fax: (044) 406-79-21



INSTRUMENT FOR MEASURING PHYSICAL AND MECHANICAL PROPERTIES OF MATERIALS BY DEPTH SENSING INDENTATION AND SCRATCH TESTING TECHNIQUES

Purpose of invention and sphere of application

The instrument is designed to measure microhardness, elasticity, creep, crack resistance, adhesion of coatings, scratch resistance and frictional force of metals, alloys, minerals, ceramics and other materials by standardized indentation and scraping methods. The instrument can be used in factory laboratories, research institutes, educational institutions, in metallurgical, mechanical engineering, aerospace, mining, and electronic industries

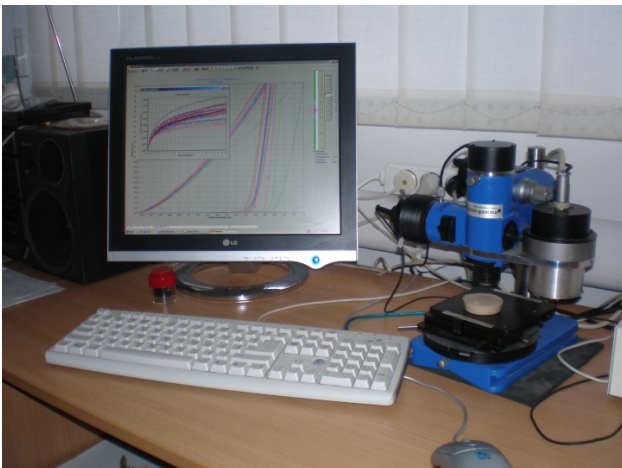

Performance-based specifications

Load range: 0.01-500 cN.
 Measured penetration depth: 0,005-200 μm .
 Loading speed: 0,01-200 cN / s.
 Holding time under load: 0-10 min.
 Scanning range: 25x25 mm.
 Scanning speed: 20 and 60 μm / s.
 Camera resolution: 5.0 mp.
 Microscope magnification: $\times 10$ -500

Key benefits of invention

Distinctive feature of the instrument is less weight, stability to external vibration, multifunctionality and productivity achieved by virtue of using the original method of measuring the penetration depth of the indenter relative to the sample surface, rather than to the bed of the instrument

Intellectual property protection status

2 patents of Ukraine have been obtained

Market demand

Demand is determined by the need to research and control the physical and mechanical properties of materials and products

Standby status

A prototype has been created, drawings of parts and circuit boards have been developed, software has been developed

Department of Scientific and Technical Information

1, Kosmonavta Komarova ave., Kyiv, Ukraine, 03058
 e-mail: vtник@nau.edu.ua, <http://nau.edu.ua/> Tel.: (044) 406-71-56, Fax: (044) 406-79-21



HYDRO-IMPULSE DEVICES FOR VIBRATION TURNING AND STRAIN HARDENING

Purpose of invention

Hydro-impulse devices for vibration turning and strain hardening are designed to facilitate the processes of blade processing of difficult-to-machine materials and strain hardening of the workpiece surfaces by imposing shock loads

Essence of invention

Vibration turning devices provide such vibration load parameters: frequency of 1-160 Hz, amplitude of 0-2 mm. Strain hardening devices: frequency of 1-160 Hz, amplitude of 0-5 mm

Intellectual property protection status

4 patents of Ukraine have been obtained

Market demand

Vibration turning devices are in demand at enterprises of metal treatment of high viscosity and difficult-to-machine materials such as stainless and high-speed steel with edge tools. Strain hardening devices are used in the manufacture of various types of workpieces, operating in heavy duty modes and during repair and renewal operations

Standby status

Experimental samples have been produced, optimal vibration load modes of the device have been well-proven in accordance with technological requirements

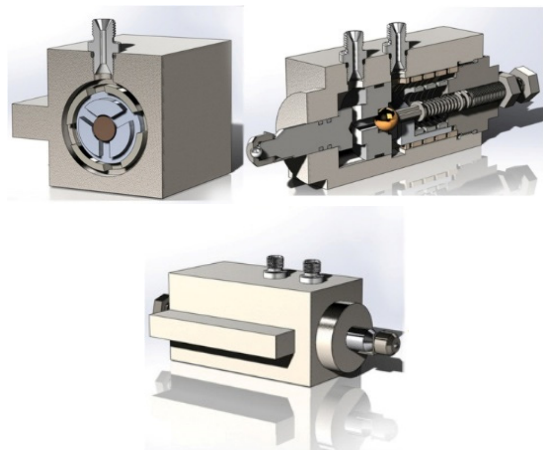
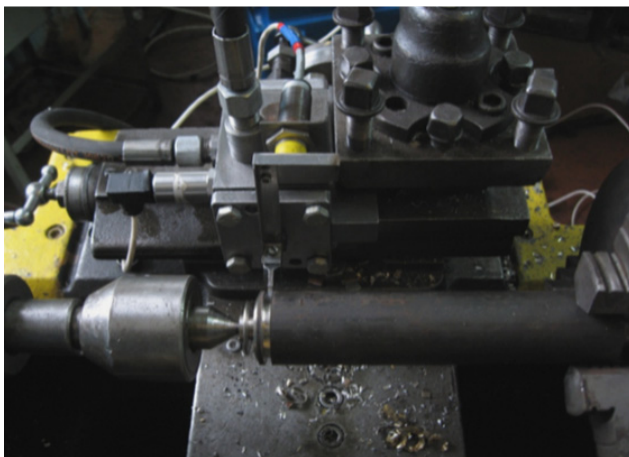

Department of Intellectual Property

95, Khmelnytske Shose Str., Vinnytsia, 21021, Ukraine

e-mail: vntu@vntu.edu.ua, <http://vntu.edu.ua/>, Tel: +38(0432) 56-08-48, fax: +38(0432) 46-57-72



STAND FOR SURFACE CLEANING FORCES MEASUREMENT

Purpose of invention and sphere of application

The invention is intended for real-time registration of forces arising during the cleaning of metal and non-metallic surfaces by brush-type working bodies. Potential users of such instruments are laboratories, enterprises – manufacturers of brush work equipment

Essence of invention

The most important component of the stand developed is an analog-to-digital converter (ADC), which converts the analog signal from the load cells to a digital signal. The conversion time of an analog signal into a digital one on a single channel is about 17.6×10^{-6} s. The accuracy of the transformation depends on the quantization step. All this became possible with the use of ADC as a 10-bit module which forms part of the PIC (Peripheral Interface Controller) microcontroller family

Intellectual property protection status

3 patents of Ukraine have been obtained

Market demand

The stand is simple in design and is effective in conducting force measurements experiments, which makes it attractive in the market

Standby status

The frame has been produced, the accuracy of the experimental results has been confirmed by the theoretical calculation

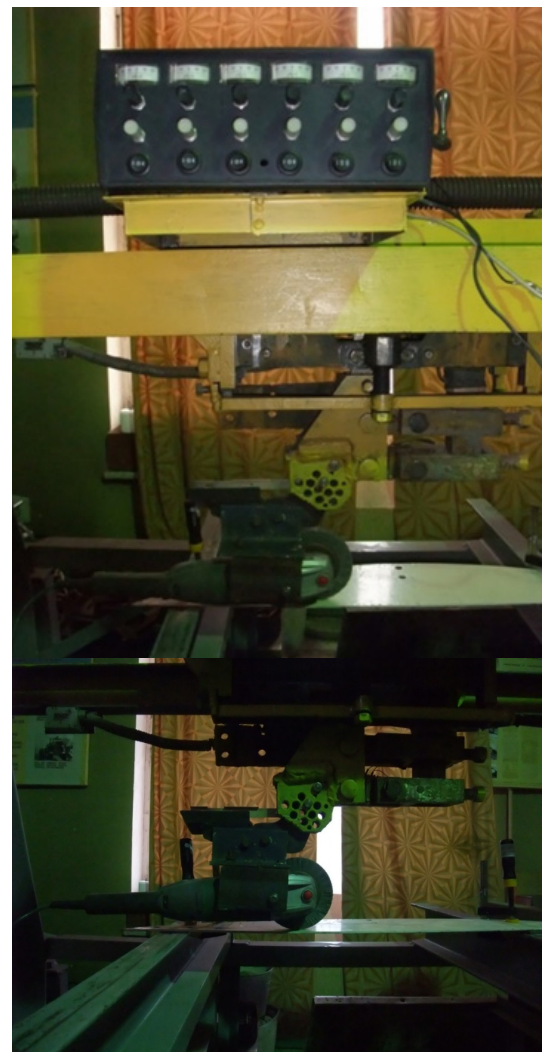

The working equipment fixed on the stand for the surfaces cleaning force measurement

Research Institute of Road Construction and Engineering Equipment

31, Povitroflotsky ave., Kyiv, Ukraine, 03037

e-mail: fomin.av@knuba.edu.ua, <http://www.knuba.edu.ua>, Tel. / fax: +38 (044) 245-42-17



UNIVERSAL DEFECTOSCOPE FOR QUALITY CONTROL OF LOW-CONDUCTIVE LAYERS

Purpose of invention

The invention is designed to control the uniformity of electrical parameters of layers with low electrical conductivity on products for various purposes. Such control ensures detection of different nature defects and is an important component of determining the quality of products. Control is necessary both in the manufacture of products and in the process of their operation

Essence of invention

In the engineering, the layers of various purposes and compositions are widely used. The layers often have heterogeneities: pores, cracks, inclusions of another phase, etc., resulting in a significant decrease in their quality. To control the presence of such defects in production conditions, instruments that meet a set of requirements are necessary: universality, efficiency and low cost of control, locality and high sensitivity of defect detection and the possibility of automation, including integration into the overall quality control system of production. The developed defectoscope meets all these requirements, in particular, provides detection of defects with a locality of 0.1 mm and more in layers on products planes of 10x20 cm size



Market demand

Such defectoscope may be used at the enterprises of mechanical engineering, instrument engineering and other industries. In Ukraine, such instruments are not manufactured

Standby status

An experimental sample has been produced. The layer testing of different composition (semiconductor, high entropy etc.) have confirmed the expected characteristics

Intellectual property protection status

1 patent of Ukraine has been obtained

R&D Department

17, Chkalova str., Kharkiv, Ukraine, 61070
e-mail: khai@khai.edu, www.khai.edu, Tel. +38 (057) 788-45-62, fax: +38 (057) 788-48-55



UNIVERSAL PIEZOREZONANT INSTRUMENT FOR GRANULAR MATERIALS MOISTURE MEASUREMENT

Purpose of invention

The universal piezorezonant measuring instrument is designed for the operational control of the moisture in substances with a discrete structure (grain crops, sugar, molding mixtures, building materials, etc.) using the dielcometric method

Essence of invention

Measuring instrument operation principle is based on the physical dependence of the substance dielectric constant on moisture. The original design of the piezoelectric-based resonance converter allows forming a single approach to measurement, which ensures the universality of the instrument and greatly simplifies its hardware implementation.

The moisture measuring instrument consists of: a universal measuring cell, a quartz measuring generator, a mixer, a digital synthesizer of the direct synthesis frequency, a microcontroller and an alphanumeric display.

The main technical characteristics are: the upper limit of measurement of relative moisture (depending on the substance) – 5-30%; resolution – 0,1%; the limit of the permissible measurement error is 0.5%; duration of a single measurement (with material loading) – no more than 1 min; power supply – 9 V battery or 9-12 V stabilized source; weight – no more than 0.85 kg

Intellectual property protection status

2 patents of Ukraine have been obtained

Key benefits of invention

The measuring instrument differs from analogues with: high accuracy and increased reliability of measurements; the only universal sensor for all types of materials; increased resource and durability; digital indication of the measurement process; simplicity and convenience of operation

Market demand

The universal piezoresonant measuring instrument for granular materials may be used in the agroindustrial complex, medicine, mining and chemical industries, both in portable design and as a part of the control and measurement systems for moisture and temperature control

Standby status

An experimental sample has been made, design documentation has been developed, and the expected characteristics have been confirmed

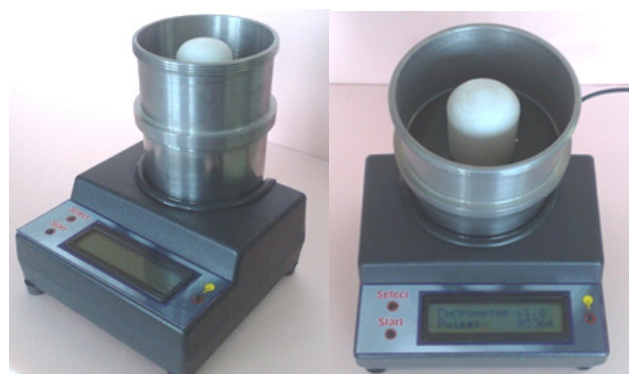

R&D Department

11, Instytutska str., Khmelnytsky, Ukraine, 29016
 e-mail: centr@khnu.km.ua, <http://www.khnu.km.ua/root/page.aspx>, Tel.: (0382) 72-55-88,
 fax: (03822) 67-42-65



EXPRESS METHOD FOR COAL ASH CONTENT DETERMINATION

Purpose of invention and sphere of application

The invention may be used for express determination of quality, in particular coal ash content, in the mining, energy and metallurgical industries. Consumer fuel quality is characterized by the ratio between combustible and non-combustible components. The commonly recognized method for determining the mineral component (ash content) of coal is the burning of a sample of fuel (ashing). The disadvantage of this approach is the significant time spent on the analysis. In conditions of industrial coal mining such time-consuming measurements are unacceptable since it is necessary to know these characteristics before the shipment of coal to the consumer

Intellectual property protection status

1 application for the patent of Ukraine on the invention has been submitted



Essence of invention

The sample is exposed to a low-power (20W) X-ray emission containing several monochromatic lines. Fluorescent radiation of chemical elements of the sample is recorded, as well as Compton and Rayleigh scattering of monochromatic radiation on the sample. The mass fraction of ash is determined from the ratio of the Compton and Rayleigh scattering peaks, taking into account the intensity of the iron fluorescence. The mass fraction of ash is measured by standard calibration method. The instrument does not require connection to water and evacuation of the housing, has dimensions of 400×150×600 mm. The reliability of the invention is determined with the use of components manufactured by Amptek (USA) as the main components (tube, detector, power unit). The cost of the instrument is 50 thousand dollars.

Standby status

An experimental prototype has been manufactured, the schematic diagrams have been well-proven, the expected characteristics have been confirmed

R&D Department

2, Kyrpychova st., Kharkiv, 61002, Ukraine
e-mail: nti@kpi.kharkov.ua, <http://www.kpi.kharkov.ua>, Tel /fax: +38(057) 707-62-13



GAS ANALYSER OF NATURAL GAS

Purpose of invention

The gas moisture meter is designed for measuring the moisture of natural gas. Relative moisture, dew-point temperature, mass fraction of moisture may be the units of measurement. The instrument is two-channel (two-wave) using the principle of feedback, which enables to achieve high accuracy of natural gas moisture measurement and sensitivity

Essence of invention

The range of moisture measurement of natural gas by dew-point temperature is from 1° to 75 °C; operating pressure is 1 atm; the measurement error is 0.1 °C; gas flow through the analyser is 2.0 ± 0.5 l / min; time of one measurement is 0.5 min; period between measurements is no more than 1 min; power consumption is no more than 30 W; the mass of the sensor is no more than 2 kg, of the processing unit is 2 kg

Intellectual property protection status

4 patents of Ukraine have been obtained

Key benefits of invention

The proposed layout differs from famous domestic and foreign analogues with a high degree of the process automation. Compared to the well-known hydrometers produced by «Michell» (CONDUMAX, S4000, DEWMET), «Marquis» (GIGROMAT 1100-02), «Toros», «Bovan» (model 241), «Kong-Prima», the gas moisture meter proposed has 2-3 times higher accuracy and 5 times higher speed. The expected annual economic effect is 32.0 thousand UAH, as the predictable cost of the gas analyser proposed is 48.0 thousand UAH, while the foreign one – at least 80.0 thousand UAH

Market demand

The invention may be in demand on the market of Ukraine

Standby status

A prototype sample has been manufactured



Department of Intellectual Property

95, Khmelnytske Shose str., Vinnytsia, 21021, Ukraine

e-mail: vntu@vntu.edu.ua, <http://vntu.edu.ua/>, Tel: +38(0432) 56-08-48, fax: +38(0432) 46-57-72



BOOK BLOCK BACK PREPARATION DEVICE FOR PERFECT BINDING

Purpose of invention and sphere of application

The device is intended to be fitted in the equipment for perfect binding of blocks, which is widely used in printing houses and is intended for publishing paperback and hardcover books, magazines and other printing products

Essence of invention

The effectiveness of the device is to provide cross-cutting application of arched grooves of the required depth on the back of the book block. The instrument consists of carriages in which book blocks are clamped, a real cog-wheel, a drive, satellite gears, to the axes of which disk tools are fixed. By simple regulation, the necessary relief is created on the back of the book block in equipment of various types (from small format to the «Trendbinder» machine with such technical parameters as: the length of the book block is up to 480 mm, its thickness is 3-80 mm)

Intellectual property protection status

2 patents of Ukraine on the invention have been obtained

Market demand

Such devices for book block back preparation may be used to re-equip production equipment of various types, designed for perfect binding

Standby status

An experimental stand has been produced, a complex of studies on the processing of book blocks made from paper of different types has been processed. A programmable relief has been obtained in a wide range of variants



R&D Department

19, Pid Holoskom str., Lviv, Ukraine, 79020

e-mail: uad.ndch@gmail.com, <http://www.uad.lviv.ua>, Tel.: +38 (032) 242-23-41, +38 (032) 252-71-68



TECHNOLOGY AND MACHINE FOR PACKAGE DECORATION BY FLOCKING

Purpose of invention

The invention concerns flocking technology for applying images by particles of natural or synthetic fiber in the form of a picture or text onto a pre-glued basis-substrate. The result should satisfy the needs of the most demanding consumers regarding the quality of packaging products

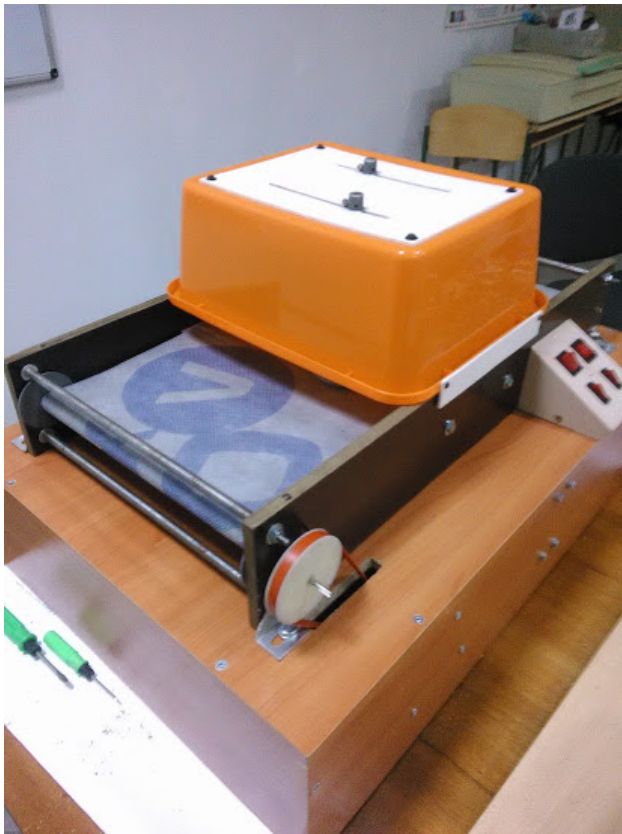

General view of the flocking machine layout

Essence of invention

The peculiarities of the formation of color flocking images are revealed, based on the structural and physical nature and interaction of flock with various substrates (paper, cardboard, corrugated cardboard, film, metal, glass) from which the package is made, which ensures the production of high-quality products. A model was developed for flocking by the method of separation, which allowed to optimize the flocking process regimes and determine the requirements for flock and adhesives; the criteria for the formation of prints quality and the evaluation of their quality by the method of laser sounding of surfaces have been established

Intellectual property protection status

4 patents of Ukraine have been obtained

Market demand

The invention corresponds with the current trend of the rapid development of the packaging industry to the search for new methods of high-quality package finishing, especially gift packages

Standby status

The machine model for the package products finishing has been developed

R&D Department

19, Pid Holoskom str., Lviv, Ukraine, 79020
e-mail: uad.ndch@gmail.com, <http://www.uad.lviv.ua>, Tel.: +38 (032) 242-23-41, +38 (032) 252-71-68



MULTI-LAYER X-RAY MIRRORS

Purpose of invention and sphere of application

Multilayer X-ray mirrors are artificially created multilayer film compositions in which a periodic alternation of layers of two materials in one direction is provided. They are used in solving fundamental and applied problems. In particular, in X-ray spectral analysis, primarily for the light chemical elements control – from Be to Cl, in astrophysics to obtain information from extraterrestrial sources of X-ray radiation, primarily from the Sun, in medicine and biology, in micro- and nanoelectronics when advancing X-ray projection lithography in the short-wave part of the spectrum (~ 6.7 nm), in experiments on plasma diagnostics, as well as in equipping synchrotrons and other X-ray sources

Essence of invention

The thickness of the individual layers of the multilayer X-ray mirror is from ~ 0.7 to 20 nm. The thickness of the entire film composition may reach ~ 0.3 -1 μm . The choice of materials for creating the multilayer X-ray mirrors is determined by the ratio of their optical constants in a given wavelength range. The multilayer X-ray mirrors are an effective tool for controlling soft X-ray radiation in the spectral range from ~ 0.7 to 50 nm. They have a reflection coefficient of up to 70% at the operating wavelength, high time and thermal resistance, may be applied to flat and curved substrates

Market demand

The developed X-ray mirrors may be used to modernize X-ray spectral instruments with large dispersion, to solve production and scientific problems, to create a new generation of scientific equipment, in particular for X-ray microscopy, plasma visualization, astrophysics, etc.



a



b

a) mirrors of the Schwarzschild lens with Co/C multilayer coating (period ~ 2.3 nm) for X-ray microscopy in radiation with a wavelength of $\lambda = 4.4$ -5 nm;

b) multilayer X-ray mirrors on a curvilinear substrate for X-ray spectral analysis

Intellectual property protection status

6 patents of Ukraine on the utility model has been obtained

Standby status

The technology of growing the multilayer X-ray mirrors for the entire wavelength range has been well-proven. Work is underway to optimize the design and increase the reflectivity of mirrors with a period of less than 2.5 nm

R&D Department

2, Kyrpychova str., Kharkiv, 61002, Ukraine
e-mail: nti@kpi.kharkov.ua, <http://www.kpi.kharkov.ua>, Tel /fax: +38(057) 707-62-13



ION-BEAM SPUTTERING SYSTEM

Purpose of invention and sphere of application

The invention is intended for the deposition of thin films by ion beam sputtering. The developed source, due to a controlled flow of charged particles on the surface being treated, is of interest both for experimental studies of the interaction of plasma flows with the surface of solids, and directly for its use in various ion-beam technological processes. The results of the work can be realized in scientific institutions of physical and technical field and directly at enterprises that produce modern science-intensive products

Intellectual property protection status

The invention is protected with the patents of the USA and Ukraine

Market demand

The invention is in demand on the markets of Ukraine, the Russian Federation and the USA

Essence of invention

The device is an autonomous ion beam sputtering system that may be connected to or placed in a vacuum chamber where the substrates are located. The device consists of one or more ion sources in aggregate with one or more sputtered targets as well as common magnetic field controlling the flow of charged particles on a processed product. The sprayed target may be under electric or floating potential. The target position may be adjusted in reference to the ion beam

Standby status

A complete package of technical documentation has been developed. A pilot copy of the sources has been produced, adjusted and investigated



Various coatings deposited by ion beam sputtering system

Innovation Centre

6, Svobody sq., Kharkiv, Ukraine, 61022.

e-mail: innovation@karazin.ua, <http://innovation.karazin.ua>, Tel./fax: +38(057) 705-52-89



COMPACT DEVICE FOR ION-PLASMA PROCESSING OF MICRO- AND NANOSTRUCTURES "TITAN-II"

Purpose of invention and sphere of application

The compact reactor of ion-plasma processing of micro- and nanostructures "Titan-II" is designed for reactive plasma processing of micro- and nanostructures in microelectronic technologies, for the deposition of thin films, and for fundamental research in the field of gas discharge physics. The results of the work may be realised in scientific organisations of physical and technical profile and directly at enterprises that produce modern science-intensive products

Essence of invention

The device "Titan-II" is a small, energy-efficient desktop unit with a high-frequency diode reactor with distributed injection and gas pumping for plasma chemical etching processes with high homogeneity. The device "Titan-II" generates flows of charged particles and reactive radicals on the processed surface with a diameter of 100 mm with an heterogeneity of less than 2% and the ability to control the energy of ions in the range of 20-500 eV. Using the reactor "Titan-II", the etching rate of silicon reached about 3 $\mu\text{m} / \text{min}$

Intellectual property protection status

1 patent of Ukraine has been obtained

Standby status

Currently the device "Titan-II" successfully operates at V.N. Karazin Kharkov National University

Market demand

The invention is in demand on the markets of Ukraine, the Russian Federation, the USA



Innovation Centre

6, Svobody sq., Kharkiv, Ukraine, 61022.

e-mail: innovation@karazin.ua, <http://innovation.karazin.ua>, Tel./fax: +38(057) 705-52-89



SOURCE OF COMBINED IONIC-ELECTRON BEAM WITH FULL CURRENT COMPENSATION

Purpose of innovation and sphere of application

The wide-range, low-energy source of combined ionic-electron beam is intended for the reactive ion-beam processing of micro- and nanostructures in the microelectronic technology, the ion-beam polishing, the thin-film deposition, as well as for the fundamental researches in the field of plasma physics and physics of charged particle beams. The results of the development will be realized in the scientific institutions dealing with physics and technology issues or directly on the enterprises producing modern science-based products

Essence of invention

The source provides the generation of superimposed beams of ions and electrons with the diameter 250 mm (diameter of working zone is 200 mm) with the possibility of independent control of ion energy in the range 50-500 eV and with the density of the ion-current in the range of 0.5-6 mA / cm² at the outlet of ion-optical system. The application of ion-optical system with the high-frequency shift provides the possibility of simultaneous extraction of positive ions and electrons. The full current compensation of beam is provided in all working modes. The source is adapted to the long-term exploitation with the applying of chemically active gases, containing fluorine

Standby status

The large-aperture, low-energy sources of combined ionic-electron beam were manufactured and now are successfully functioning at both The V. N. Karazin Kharkiv National University and at the LLC SPA "Saturn"

Market demand

The innovation is in demand on the market of Ukraine and other countries

Intellectual property protection status

1 patent of Ukraine and 1 patent of the Russian Federation have been obtained

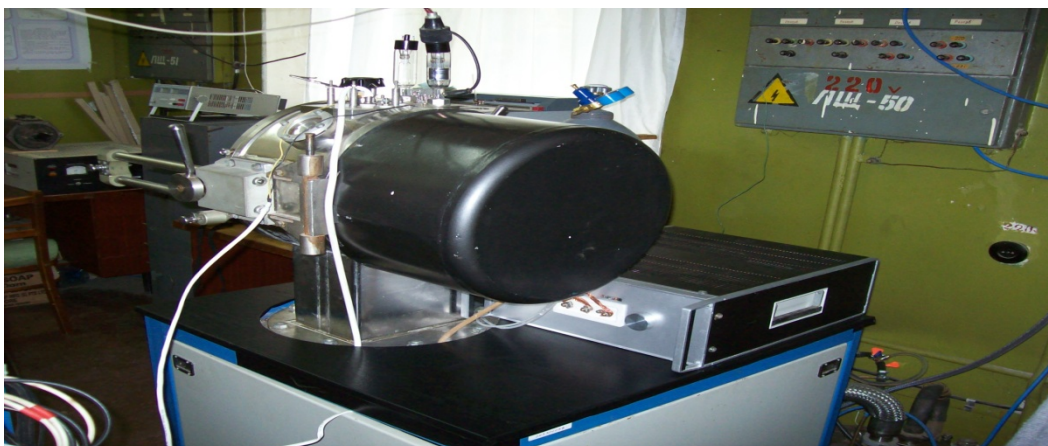

INNOVATION CENTRE

6 Svobody Sq., Kharkiv, 61022, Ukraine;
e-mail: innovation@karazin.ua, <http://innovation.karazin.ua/>, Tel./fax: (057) 705-52-89



TEST DEVICE FOR SUPERCAPACITORS PARAMETERS' MEASUREMENT

Purpose of innovation and sphere of application

The 10-channel device is designed for measuring the parameters of supercapacitors in different measuring modes:

- galvanostatic 1 - charge/discharge with direct current;
- galvanostatic 2 - with current-interruption in case of achieving the ultimate voltage values;
- galvanostatic 3 - sequence of charges with the interruption of current after each charge and at the end of the discharge;
- combined-galvanostatic and potentiostatic, which combines a charge/discharge with constant current and maintenance of the final given voltages.

The device is used in laboratories of enterprises and scientific and research institutions in the field of instrument engineering

Intellectual property protection status

The patent of Ukraine has been obtained

Market demand

The 10-channel device designed for supercapacitors' parameters measuring is successfully used at the LLC "Yunasco-Ukraine"

Standby status

The technical documentation has been designed; the development is ready for implementation

Essence of invention

The main functions of the device are the regulation (maintenance) of the given potential of the researched (working) electrode in the potentiodynamic mode or the regulation (maintenance) of the given current of polarization in the circle of the researched (working) electrode in the galvanostatic and the combined-galvanostatic modes regardless of the processes occurring in the electrochemical cell. The regulation of the potential of the working electrode is carried out by automatic measurement of the polarizing (output) current of the stand.

The regulation of the current polarization in the circle of the working electrode is carried out by automatic change of the output voltage of the stand.

Number of measuring channels -10.

Range of voltage setting - from 0 to +3.5 V.

Range of current setting - + 100 A.

The measurement margin error of current - 0.5%.

The measurement margin error of voltage - 0,5%.

The minimum pick time of the voltage and current of the stand in each channel - 10 mSec



10-channels test device for measuring the parameters of supercapacitor

R&D Department

11 Instytutska Str., Khmelnytskyi, 29016, Ukraine
e-mail: centr@khnu.km.ua, <http://www.khnu.km.ua/root/page.aspx>,
Tel.: (0382) 72-55-88; ((0382) 67-02-76), fax: (03822) 67-42-65



BEAM-CONTROLLED SEMICONDUCTOR RESONATOR

Purpose of invention and sphere of application

E-beam controlled semiconductor resonator is intended for the usage during the development of frequency-selective devices

Essence of invention

The device is based on the dependence of the amplitude-frequency and phase-frequency characteristics of the semiconductor resonant p-and-n-structure from the direct current, which is passed through it, and which gives the opportunity to provide smooth control of the resonant frequency and phase shift of such structure.

Operating frequency range: 60 to 70 GHz.

The product of its own Q-factor for the resonant frequency: 2000 GHz.

Power supply voltage of control circuit: no more than 3 V.

Power consumption of control circuit: not more than 0,6 MW per section.

Range of phase shift control for one section: 0-140 degrees.

Resonant frequency tuning range: up to 2%

Market demand

The demand is stipulated by the necessity of developing the devices of millimeter wavelengths range for various purposes. It is important that the process of their manufacturing can be based on existing planar technology that provides the fundamental possibility of integration on the one crystal resonance elements, transmission lines, as well as active and passive components

Standby status

The R&D project has been developed; the experimental prototypes have been designed and have been studied.

Intellectual property protection status

1 patent of Ukraine has been obtained

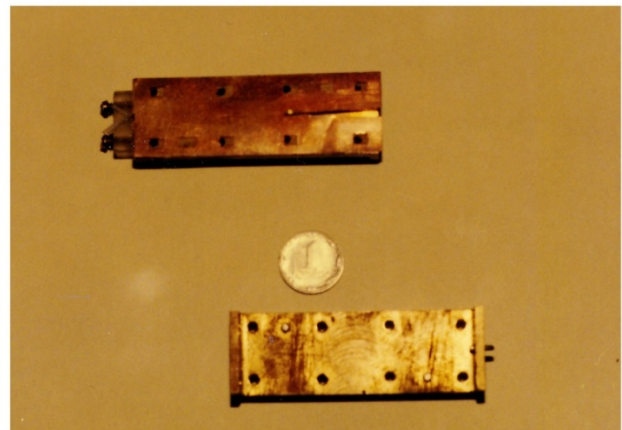

8. Building technologies And Vehicles





BUNDLED REINFORCING STEEL BARS WITH THE STRENGTH INDEX 600 MPa FOR THE FERRO-CONCRETE FRAMES

Purpose of invention and sphere of application

Bundled steel with the strength index 600 MPa is designed for reinforcement of nontensional and tensional ferro-concrete constructions. Such bundled steel can be used as reinforcing element in cast-in-place and prefabricated ferro-concrete constructions in the industrial facilities and residential constructions, as well as in structural elements of buildings in the form of separate hinges, for reinforcing highways and flying field coverage

Essence of invention

Bundled reinforcing bars with the strength index 600 MPa are delivered in the form of periodic range hinges with the diameter from 4.0 to 18.0 mm which are formed in a bundle with the help of cold plastic deformation of the round wire rod made of ordinary low-carbon and low-alloy steels, possess conditional yield point ($\sigma_{0,2}$) not less than 600 MPa, rupture stress rate (σ_H) not less than 670 MPa, the ratio ($\sigma_{0,2}/\sigma_H$) not less than 1,08 and total relative elongation during the maximum load not less than 3%. It is made with the usage of strength accumulation principle at the stages of recycling, which are summarized as: 1 - thermal hardening of wire rod; 2 - hardening by means of cold deformation during the shaping of periodic profile; 3 - hardening of finished products by the tempering in conditions of electrothermal tensioning

Key benefits of invention

Bundled reinforcing steel bars with the strength index 600 MPa correspond to DIN 488 with its mechanical properties. Its application provides steel savings up to 20% in constructions due to increased durability, as well as metal saving up to 5% by reducing cutting cost

Intellectual property protection status

3 patents of Ukraine have been obtained

Market demand

The demand for reinforcing bars with the strength index 600 MPa is more than 300 thousand tons per year

Standby status

Technology parameters have been worked out. The commercial batch of bundled reinforcing steel bars with the strength index 600 MPa and with the diameter 10 mm in terms of hardware production has been produced



The bundles of reinforcing bars with the strength index 600 MPa

Department of Intellectual Property and Commercialization of R&D Products

4 Haharina ave., Dnipro, 49600, Ukraine

e-mail: projdak@metal.dmeti.dp.ua, <https://nmetau.edu.ua>, Tel./fax: +38(056) 745-41-96



RESOURCE-EFFICIENT TECHNOLOGY OF FACADE CERAMIC MATERIALS PRODUCTION

Purpose of invention and sphere of application

The R&D product in the form of complete technological cycle of production is intended for the usage by domestic manufacturers of ceramic materials in the construction industry.

Essence of invention

The developed technology is based on the principles of the resources and energy saving and provides the usage raw materials of high-carbon waste of flotation enrichment of pure coal that is formed and is accumulated at the coal-mining enterprises of Ukrainian regions. The key feature of the developed technology is the application of coal waste pre-heat treatment at the burning temperature of the volatile substances and the products of their pyrolysis (~550°C). Such technological approach provides controlled removal of excess carbon from waste to its final amount at an average rate 3.5 % and leads to partial thermal deformation of the clay minerals that transform by-products of coal to a low-carbon pseudo-clayish raw material with activated mineral part. The technology involves semi-dry pressing of semi-finished products and their burning in the ordinary mode at 970 °C (for bricks) and 1030 °C (for tiles). Conditions for saving a gas fuel at the expense of residual coal in prepared by-products of coal, which performs the function of fuel component of masses, consuming for the burning of semi-finished products (80% of the required volume), is created, which provides a significant economic effect.

The usage of the organo-mineral raw materials in the amount 80-85% together with 15-20% of abundant local clay leads to developing of production technology of high-quality facade ceramics (brick, tile) with properties that satisfy requirements of the relevant domestic standards, harmonized with European regulations

Intellectual property protection status

3 patents of Ukraine have been obtained

Market demand

The demand for the development of domestic building ceramics by domestic enterprises is stipulated by the need of reducing production fuel costs and utilization of waste from a waste recovery. The proposed technology is in demand primarily for enterprises, territorially located in the coal-mining regions of the country, in particular by PJSC "Severodonetsk Plant of Building Structures and Materials ", LLC "Tseglyar", LLC "Westclinker Group", etc.

Standby status

The R&D product is ready for implementation



R&D Department

2, Kyrpychova str., Kharkiv, 61002, Ukraine

e-mail: nti@kpi.kharkov.ua, <http://www.kpi.kharkov.ua>, Tel./fax: +38 (057) 707-62-13



TECHNOLOGY OF MANUFACTURE OF FIBERGLASS PRODUCTS WITH VARIOUS TRANSVERSAL-ISOTROPIC STRUCTURES

Purpose of invention and sphere of application

The aim is to provide the given ratio of strength in the lengthwise and cross-wise directions in obtaining hollow glass-reinforced plastics articles of cylindrical shape depending on the distribution of the operational load. Potential users of this method are enterprises that produce pipes for transportation of cold and hot water, corrosive medium and oil products, high pressure pipelines (up to 10 MPa), standpipes and storage tanks for solid and liquid chemical products, air ducts of ventilation systems, rocket envelopes and missile launching containers

Essence of invention

The key features of the development are the possibility of implementation of the cross-fibered twist-and-steer winding by one-step uninterrupted method without stopping the rotational movement of mandrel, and also the regulation of the physical and mechanical properties in the twist-and-steer directions with provision of possibility to change the so-called transverse-isotropic structure according to the anisotropy factor ranging from 1 to 3. At the same time the increase in the coefficient of anisotropy leads to redistribution of physical and mechanical rates with their gradually increase in the cross-wise direction and their decrease in the lengthwise direction

Intellectual property protection status

1 patent of invention of Ukraine has been obtained.

Key benefits of invention

The designed method of manufacturing of fiberglass products with various transversal-isotropic structures allows:

- to ensure uniformity and stability of physical and mechanical properties of products;
- to regulate physical and mechanical properties and their ratio in the lengthwise and cross-wise directions;
- to reduce the time for conducting researches during the obtaining of products for different operating conditions;
- to control the strength properties in the process of products manufacturing.

Market demand

The technology can be used by enterprises that manufacture cylindrical products, consisting of fiberglass with the help of cross-fibered twist-and-steer winding.

Standby status

The development was implemented at the LLC "Fiberglass pipes". The engineering documentation is required for implementation at other enterprises



Fiberglass pipes

R&D Department

2 Kyrpychova str., Kharkiv, 61002, Ukraine

e-mail: nti@kpi.kharkov.ua, <http://www.kpi.kharkov.ua>, Tel./fax: +38 (057) 707-62-13



INNOVATIVE PRODUCTS MADE FROM FOREST RESIDUES

Purpose of invention and sphere of application

The R&D project is intended for the usage of the forest residue, a considerable part of which are branches, not used in the manufacture of slab materials and fuel due to the high content of bark

Key benefits of invention

A well-known structural material - OSC slabs (Oriented Strand Board) that are characterized with multioperational and energy intensive technological process of manufacturing, density and mechanical characteristics (strength limit at static bending and elasticity modulus) that are smaller to 25 and 77% in comparison with similar properties of a proposed new wood-composite material from pressed branches

Intellectual property protection status

3 patents of Ukraine on utility model have been obtained

Standby status

Experimental samples of slabs were produced, the technology has been designed and regulations for technological processes have been developed

Essence of invention

The technology of rational usage of branches as a wooden component for the wood-slab materials by squashing is developed in order to keep the natural strength of the fibers. Raw materials for the production of product are poplar branches with the diameter from 13 to 32 mm, which as the result of pressing form knitting with the elements thickness 6-10 mm and after gumming by phenol-formaldehyde resin become the basis of three-layer pressed materials with the medium density 640-800 kg / m². Tensile strength at static bending is 30-37.5 MPa, the modulus of elasticity is 7000-10000 MPa

Market demand

The new wood-composite material can replace OSB slabs in constructions and the usage of forest residue i.e. branches that are burned today, will improve the ecological status of logging sites



Three-layer wood-composite material on the basis of pressed branches of poplar with perpendicular direction of fibers

R&D Department

15, Heroiv Oborony str., Kyiv, 03041, Ukraine

e-mail: org_section@nubip.edu.ua, <https://nubip.edu.ua/about>, Tel./fax: +38 (044) 527-85-89



SUPER FAST-CURING ALKALI CEMENTS AND CONCRETES

Purpose of invention and sphere of application

The R&D product is intended for ensuring the fast construction and restoration of concrete and reinforced concrete constructions with strategic role, including for the purposes of increasing reliability and durability of defense structures, usage in 3D printing technology of building structures with various architectural forms, where the speed of early concrete constructive

Essence of invention

Early strength of cements and concrete (2-3 h) during the compression 10-30 MPa with regulated viability within 10-50 minutes with further stable growth durability within 28 days to values of 80-120 MPa, high regulated conformance ratios $R_{zg} / R_{st} > 0,12$, which characterize the crack resistance of the materials

Key benefits of invention

Compared to the known analogues, the obtained cement and concrete is characterized by an increased to 2-5 times early stiffness' obtainment speed

Intellectual property protection status

2 patents of Ukraine on utility model have been obtained

Market demand

The developed materials are of a special interest in the field of additive technologies in construction with their technological and constructive characteristics, namely, during the introduction of 3D printing technology in building structures of different purposes. The potential consumers of such cement and concrete can be constructional companies specialized in transport construction (tanncodromes, manufacturing and quick repairs of aerodrome runways, bridges structures, etc.), constructive departments of the State Emergency Response Service and the Ministry of Defense of Ukraine for the constructions of protective structures with different purposes, incl. for counteracting dynamic, seismic and explosive loads

Standby status

The experimental samples were manufactured and tested; the methods of controlling technological and physical and mechanical concrete characteristics are developed and worked out. The regulatory framework of cements and concrete usage is in stock of the developer

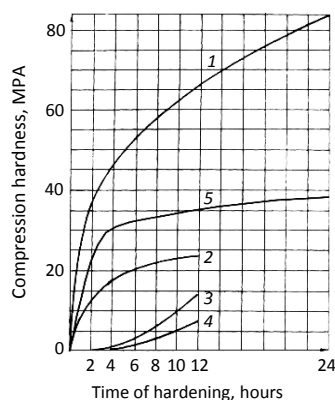

Early strength of cements:

- 1 - alkaline Portland cement;
- 2 - cement "Pirament" (USA);
- 3 - cement of type 1 for ASTM C293;
- 4 - cement of type 3 for ASTM C293;
- 5 - slag cement on liquid glass



Destruction of the filler after the concrete test

Research Institute of Road Construction and Engineering Equipment

31, Povitroflotsky ave., Kyiv, 03037, Ukraine

e-mail: fomin.av@knuba.edu.ua, <http://www.knuba.edu.ua>, Tel./fax: +38 (044) 245-42-17



ALKALI CEMENT AS EFFECTIVE MATERIALS OF RADIOACTIVE MATERIALS UTILIZATION

Purpose of invention

Effective immobilization of radioactive waste with low and moderate levels of the activity resulting from the process operation of nuclear power plants (NPPs)

Essence of invention

The essence of the development is the use of cementation technology of radioactive waste in the matrix of alkaline cement. The usage of alkaline cement provides a possibility to increase the amount of radioactive waste up to 20% during the simultaneous preservation of high immobilizing properties (leaching of radioactive components at the level 10-3- 10-5 mg / g). The material is inflammable, resistant to biological corrosion, not capable to be autoignition, etc.

Intellectual property protection status

2 patents of Ukraine have been obtained

Key benefits of invention

The developed materials have no analogues in the world with their rates of filling the final product with the radioactive waste and related operational characteristics

Market demand

The development is relevant to all nuclear power plants of Ukraine and abroad. Applicability and the effectiveness of the development are confirmed by the increasing of contracts for work on national joint stock company "Energoatom" and foreign customers

Standby status

Experimental samples were produced, technological schemes of production were designed, laboratory and physical tests were conducted



Tests of a sample in conditions of the NPP laboratory

Research Institute of Road Construction and Engineering Equipment

31, Povitroflotsky ave., Kyiv, 03037, Ukraine

e-mail: fomin.av@knuba.edu.ua, <http://www.knuba.edu.ua>, Tel./fax: +38 (044) 245-42-17



HIGH-MELTING COMPOUND-BASED SPECIAL CEMENTS AND CONCRETES

Purpose of invention and sphere of application

Special cements with enhanced physical-mechanical properties and operational characteristics are designed for lining of high-temperature chemical aggregates, metallurgical and oil refining industries that work in extreme conditions. Proposed materials can be made on existing enterprises of cement and refractory industries without additional expenditures

Essence of invention

Original composition of special cements has been developed on the basis of refractory compounds and concretes with their usage of high performance rates: compressive strength - 40-70 MPa, fire resistance - 1700-2500 C, thermal resistance - more than 20 heat-shifts, degree of hardening in the interval of temperatures 100-2200 C not more than 20%; slag, radiation and corrosion resistance

Intellectual property protection status

11 patents of Ukraine for the invention and utility models have been obtained

Market demand

Estimated volume of demand in the home market - more than 500 tons per year, the expected price of the goods - 3,2 thousand UAH per ton, the plan of expected realization products - 1600 thousand UAH per year



Clinker and special cement

Key benefits of invention

Proposed materials are competitive and do not have any global analogues according to certain characteristics. Engineered concrete, rammed and sprayed mixtures have a number of advantages in comparison with lining made of artificial refractory products: labor-intensive and over-price operation of burning the products are excluded, it is possible to obtain cast-in-situ large-scale lining and complex configuration. Application of developed refractory materials allows to increase the linings term of working lifespan in 1,5-2 times, to reduce the amount of technological stops and preventive maintenance and to lower energy costs and lining manufacturing cost. Substitute of binders that is used today in radiation-resistant concrete, with the proposed non-traditional cements will allow to increase the operational properties of protective materials (since in such case the "firing" will be excluded along the binding substance in concrete), and also to reduce the thickness of layer of half-attenuation if ionizing radiation in 1,5-2 times

Standby status

Experimental samples have been produced; the parameters of synthesis of materials for envisaged characteristics obtainment have been designed

R&D Department

2 Kyrpychova str., Kharkiv, 61002, Ukraine

e-mail: nti@kpi.kharkov.ua, <http://www.kpi.kharkov.ua>, Tel./fax: +38 (057) 707-62-13



HIGH STRENGTH STONE MASTIC ASPHALTS

Purpose of invention

Stone mastic asphalts (SMA) are intended for the construction of asphalt-concrete rough and collision-proof coverings of highways of the highest category. They are widely used in Europe and most recently in Ukraine

Essence of invention

Proceeding from the principle of regulation of the properties of bituminous binders by adding the fractional component into the mixture, the composition of the SMA has been developed, in which structuring, resistance against segregation and viscosity increasing are provided with the help of predetermined ratio of bituminous binder and powder

Intellectual property protection status

1 patent of Ukraine on utility model has been obtained

Key benefits of invention

The proposed SMA differs from traditional one with considerably higher stability of the composition at all technological stages and strength. Modulus of elasticity in such stone mastic asphalts is 1.5 times higher than in traditional Western European ones. There is no need in expensive polymeric import fibers, and, accordingly, the manufacturing expenditures of SMA decrease by 20-25%

Market demand

The development has been made on the request of the State Agencies of Motor Roads of Ukraine. It can be used during the laying of the upper coats of road coverings of the country highways

Standby status

The development is complete; it may be shown to those interested in the road structures building. The production and laying of high strength stone mastic asphalts into the coating do not require any special equipment

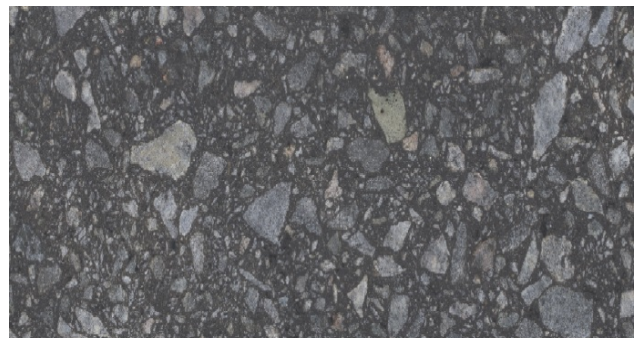

Department of Intellectual Property

25, Yaroslava Mudroho str., Kharkiv, 61002, Ukraine

e-mail: intellect@khadi.kharkov.ua, <http://www.khadi.kharkov.ua>, Tel./fax: +38 (057)



BITUMINOUS BINDERS COHESION DENSITY MEASURER

Purpose of invention and sphere of application

The evenness of the asphalt concrete covering is one of the main indicators of its good quality. In order to prevent the formation of plastic strains it is necessary to get information about the penetration number of bituminous binders. The method for determining cohesiveness has been developed in order to get such data. Using the indicator of cohesion, it is possible to anticipate and correspondingly regulate the shear-resistance and abrasion resistance

Essence of invention

The cohesionmeter, special instrument, was developed for determining the cohesiveness. It functions under the scheme of single-shear displacement at fixed temperatures and shear rates, which most meet the working conditions of asphalt concrete in coverings. The substrate taken for research is a lining made of flexible one polymer tape that provides reliable adhesion bond between it and tested binder, as well as the alignment of tapes, which stretch in opposite directions

Intellectual property protection status

1 patent of Ukraine has been obtained

Key benefits of invention

The main benefits of the invention set it apart from the French shock method of the pendulum and cohesiometer of the firm "Dupont" (USA), in which a low-adhesive glass and bulky press are used as a solid surface. The developed cohesion meter allows measuring the cohesion of bitumens of different types and kinds, bitumen-polymer binders, and binders with various alloys

Market demand

The cohesion meter is used for research needs for more than 20 years. Now the State Standard project is at the stage of approval, the indicator of cohesiveness is standardized in DSTU B V.2.7-135: 2014 and included in the draft standard of DSTU 4044-20XX, which is under development for replacement of State Standard 4044-2001

Standby status

The development is suitable for usage in production. The first three cohesion meters are produced by KHNADU jointly with SE "Dorcentr"

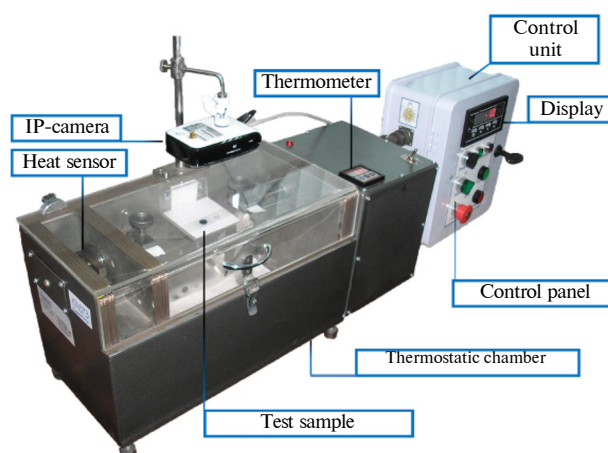

Department of Intellectual Property

25 Yaroslava Mudroho str., Kharkiv, 61002, Ukraine
e-mail: intellect@khadi.kharkov.ua, <http://www.khadi.kharkov.ua>, Tel./fax: +38 (057)



ROAD SURFACE WHEEL TRACKING MEASUREMENT DEVICE

Purpose of invention and sphere of application

The device is intended for the measurement of cross-sectional surface taping in order to conduct wheel tracking detailed analysis, identify its type, reveal the causes of its occurrence, study its changing with the flow of time to forecast and evaluate the wheel tracking resistance of the road structure

Essence of invention

Dimensions: 2500 x150 x300 mm.
 Weight: 12 kg.
 Measuring range of the laser sensor distance: 80-320 mm.
 The speed of carriage: 20 m / s.
 Profile recording time: 20 seconds.
 Power supply (or supply voltage) : 12V

Key benefits of invention

Comparing with the other measurement systems this device enables to calculate a maximum rut depth as well as a rut transverse configuration, which is important for the defining of rutting causes. It doesn't need a computer in the process of measuring the cross-wise profile that provides the mobility and independence of operation

Market demand

Potential customers of the device are enterprises subordinated to the State Service of Motor Roads of Ukraine and regional road services of Ukraine

Intellectual property protection status

An application for the patent on utility model is being held up

Standby status

An experimental prototype of the device has been developed

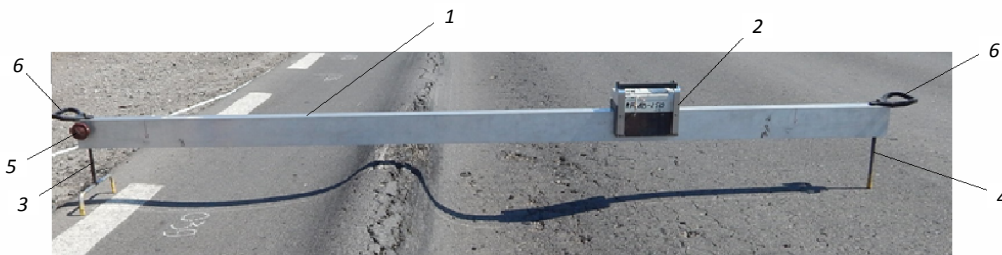

1 – Beam; 2 – Travelling Carriage; 3 – Left Bearing Part; 4 – Right Bearing Part; 5 – Left Bearing Part Lock; 6 – Carrying Handles of the Device

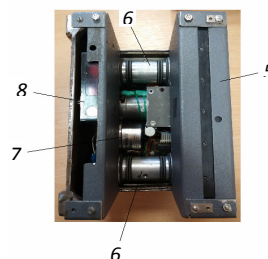
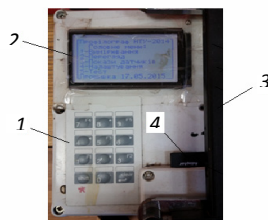

1 – Keyboard; 2 – Display; 3 – Swing-Type Carrying Handle; 4 – Flash Drive; 5 – Box; 6 – Drive Rollers ; 7- Electric Motor; 8- Laser Sensor

Technology Transfer, Innovation Activity and Intellectual Property Department

1, M. Omelianovycha-Pavlenka str., Kyiv, Ukraine
 e-mail: nttm@i.ua; <http://www.ntu.edu.ua>., Tel.: +38(044) 288-71-01



LASER CALIBRATION SYSTEM

Purpose of invention and sphere of application

The development is intended for examining of the condition of surface of road coatings (foundations). The software allows performing the measurements, recording the data and determining the evenness of coatings in the lengthwise direction, by IRI (International Roughness Index) in particular. Should 18 measuring laser sensors be installed, it is possible to estimate the cross-section evenness of the road coatings and to determine the parameters of the rut

Intellectual property protection status

1 patent of Ukraine has been obtained

Essence of invention

Number of laser sensors: from 1 to 18
 Measuring range of roughness: 0.1 - 500 mm
 Roughness measurement resolution: 0.1 mm
 Operating speed: up to 80 km/h
 Number of operating modes: 2
 Measurement broadness: 2 m and 3.7 m

Standby status

The R&D is ready for production. It has been tested by the following production organizations: SE Center of Scientific and Technical Support of Road Works and Certification of Road Products ; SE Ukrainian State Institute of Road Facilities Design



Department of Intellectual Property

25, Yaroslava Mudroho str., Kharkiv, 61002, Ukraine
 e-mail: intellect@khadi.kharkov.ua, <http://www.khadi.kharkov.ua>, Tel./fax: +38 (057)



SOIL SAMPLING PLANT WITH THE POSSIBILITY OF CORRECTING THE TRAJECTORY OF SOIL SAMPLING WORKING BODY

Purpose of invention and sphere of application

The plant is intended for trenchless laying of underground engineering communications (water pipes, cable lines, bus-structured gas networks, etc.) at sections of junction of networks with roads, tramways and other engineering structures with the possibility of bypassing. Potential users of the plant are construction and assembly enterprises engaged in the field of laying of communications



Soil sampling plant with the correction of the trajectory in soil "UHKR180"

Essence of invention

Special working body with the option of operatively changing the shape of the tip for the cone is used to correct the trajectory of motion during sampling of a soil i.e. for axial displacement, and slanted plane, or for correction of motion in the case of an unpredictable deviation from the axial movement. A screw coupling and a locking device mounted on a hydraulic cylinder can control the movement of the working body during a soil sampling without the process interruption. The proposed solution allows improving sampling accuracy and extending the usage of static sampling method from 20 m long hole to 100 m.

The diameter of the pioneer rodding of the soil - 65 mm.

Possible expansion of the well - 273 mm.

The length of spells of rodding - 100 m.

The nominal fluid pressure in a hydraulic actuator - 16 MPa

Intellectual property protection status

2 patents of Ukraine have been obtained

Market demand

Hundreds of Ukrainian construction companies engaged in the construction of underground communications can be equipped with such plants

Department of Intellectual Property

25, Yaroslava Mudroho str., Kharkiv, 61002, Ukraine

e-mail: intellect@khadi.kharkov.ua, <http://www.khadi.kharkov.ua>, Tel./fax: +38 (057) 707-36-70



TECHNOLOGY AND EQUIPMENT FOR THERMAL REINFORCEMENT OF STAMPED-WELDED JUNCTION PIECES FOR MAGISTRAL PIPELINES

Purpose of invention and sphere of application

The R&D product is intended for manufacturing low-carbon low-alloy stamped-welded junction pieces with the diameter up to 1420 mm (wall thickness from 14 mm to 100 mm) per strength level X80 (K65) that allows meeting the standard operational properties and reduce product wall thickness

Intellectual property protection status

More than 10 patents of Ukraine and the Russian Federation have been obtained

Standby status

The technology and equipment were designed and implemented in the industry at the main manufacturing enterprise that specializes in producing of junction pieces for pipelines

Essence of invention

Thermal reinforcement mode has been developed with the view to reinforce junction pieces, tempering, structural and technological parameters for hardening equipment, cooling water-based medium that allows receiving ferrite-bainite or bainite structure and standard properties. Developments were created for the first time in the CIS

Market demand

The demand in the high-quality junction pieces is calculated according to the following approximated figures: over 100 tons of details are needed for 100 km of oil and gas pipeline, pump or compressor house require over 100 tons of details per 100 km for completing units of machine. Major oil and gas pipelines have been used over 30-40 years in CIS, with that exceeding their warranty period that is there is a need of overhaul and technical change



Department of Intellectual Property and Commercialization of R&D Products

4, Haharina ave., Dnipro, 49600, Ukraine

e-mail: projdak@metal.dmeti.dp.ua, <https://nmetau.edu.ua>, Tel./fax: +38(056) 745-41-96



COAXIAL-LINE ENGINE WITH PERMANENT MAGNETS SERVING AS AN ACTUATING DEVICE OF CONSTRUCTION PLANTS AND OSCILLATING MECHANISMS

Purpose of invention and sphere of application

Coaxial-line motor with constant magnets can be used as an actuating device in oscillating systems in building industry and other fields, e.g., during the stability testing of various machines and mechanisms, buildings and structures at different frequencies and resonant oscillations

Intellectual property protection status

7 patents of Ukraine have been obtained

Market demand

Similar vibrators can be used by construction companies and in other industries

Standby status

The developed experimental sample of the vibrator was investigated comprehensively until its destruction, which allows identifying positive and negative properties. The development is ready for manufacturing on electromechanical enterprises of Ukraine

Essence of invention

The developed experimental vibrator based on coaxial-line engine with permanent magnets is used for piles dipping via vibrostatic way, and has the capacity of 4.8 kW, resonance frequency 17.1 Hz, inertial force 48 kN and weight 280 kg



Vibro-hammer based on coaxial-line engine with permanent magnets



COLLAPSIBLE TRACK WHEELED PAIR 1435/1520

Purpose of invention and sphere of application

The wheeled pair is intended for installation under passenger and freight rail cars on the tracks with the diameter 1435/1520 mm

Essence of invention

The development is used in loading trolleys from the wheeled pair on the rail 23.5 tf. The wheeled pair which is equipped with bearings of cassette type TBU 150*250*160, steel wheels of the "T" brand, is installed in the solebar jaw opening with the help of adapter

Intellectual property protection status

2 patents of Ukraine have been obtained

Market demand

The railroad market of the CIS countries and the European Union

Key benefits of invention

The distinctive features of the created wheeled pair with collapsible wheels are the lack of large stresses arising in the toothed coupling during the entrance of railroad car in the curved track and during the interaction of wheels with track irregularities, as well high reliability of control nodes operation to wheels rearrange. Application of sliding wheeled pair allows not carrying cargo-unloading works at the points of break-of-gauche 1435/1520 mm, which accelerates crossing capacity of break-and-gauche points and reduces the cost of delivery goods to the final user

Standby status

The full package of the design documentations was developed

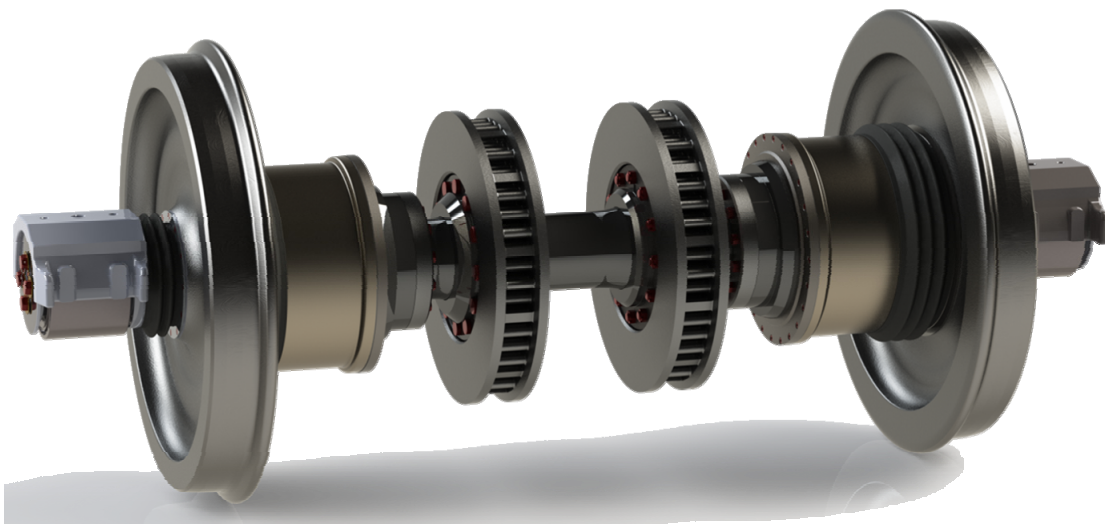

DESIGN AND DEVELOPMENT TECHNOLOGICAL BUREAU

2, Lazariana str., Dnipro, 49010, Ukraine

e-mail: pktb.diiit@gmail.com, <http://www.pktbdiiit.wordpress.com>, Tel. +38 (097) 818-75-19,

fax: +38 (097) 371-51-12



DUST CONCENTRATION FREQUENCY METER (DCFM-2)

Purpose of invention and sphere of application

The mass dust concentration meter is intended for measuring of the dust content in the air of various origin and chemical composition during the control of exceeding of maximum allowed concentration in the working area (in accordance with State Standard 12.1.005-88), technological control of air conditioning systems, ventilation systems and purity of objects with different purposes, as well as alarms at exceeding the preset limits after calibration at the place of operation by a comparative method

Essence of invention

The frequency meter of dust concentration is based on the optical method of measuring the dust concentration without its predeposition. The dependence of the reactive properties and negative resistance of semiconductor devices on the influence of external physical quantities is used in the development and consequential creation of a new class of microelectronic frequency converters for the concentration of gases, dust, pressure, humidity and temperature. In the developed device, the concentration of dust and other external influences is converted into the frequency signal, which allows to create radio measuring microelectronic converters using integrated technology as well as to increase the speed, accuracy and sensitivity, extend rating of measure and improve reliability, noise immunity and long-term stability of parameters.

Technical characteristics: time of one measurement is 15 c.; measuring the concentration of dust on the first channel (Particle size 0.2 - 2.5 mkm) 0-50 mg / m³ is 0-150,000 particles; measuring the concentration of dust on the second channel (the size of the particles 2.5 - 10 microns) 0 -250 mg / m³ is 0-2500000 particles.; measuring margin 2.5%.; dimensions of the device are 130x100x36 mm. Weight – 220 gr.

Intellectual property protection status

5 patents of Ukraine have been obtained

Market demand

The device can be used in security systems in airports, railway stations, metro stations, aircraft engineering, space technology, chemical industry, mining, automobile transport, medicine, agriculture, and for environmental monitoring in Ukraine and other countries.

Standby condition

The experimental batch of the devices (10 items) has been produced and the operational tests have been carried out

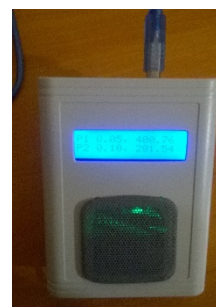

Design of DCFM

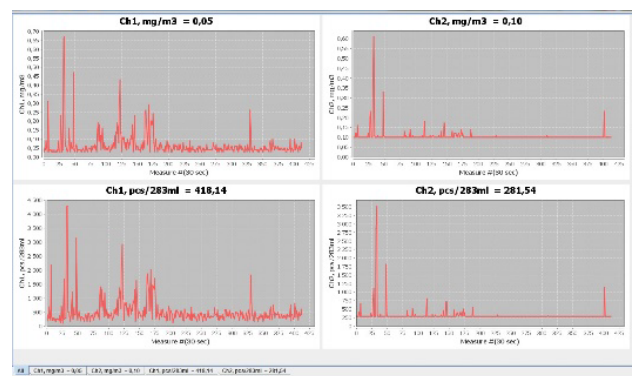

DustMeter interface

Department of Intellectual Property

95 Khmelnytsky Shose, Vinnytsia, 21021, Ukraine

e-mail: vntu@vntu.edu.ua, http://vntu.edu.ua, Tel .: +38 (0432) 56-08-48, fax: +38 (0432) 46-57-72



TWIN-ENGINED UNMANNED AIRCRAFT M-7V5 “NEBESNIY PATRUL”

Purpose of invention and sphere of application

Unmanned aircraft (UAC) is intended for performing aviation works for the benefit of different branches of economy. It can be used for cartography and aerial photography, video surveillance in the real time, etc. The UAC is supplied with a ground control station. Potential users of the UAC are civil airlines, force and special bodies of Ukraine

Essence of invention

M-7V5 “Nebesniy patrol” is a twin-engine aircraft of a normal scheme with high mounted wing. The front and rear parts of the gondola are made in the form of removable trimmings. In the front part of gondola there is a porthole for the camera installation. The main technical characteristics of UAC: take-off mass – up to 200 kg; payload mass - up to 70 kg ; max. speed – 250, km/h; max. altitude of flight - up to 6000 m; max. duration of flight – up to 10 hours; type of take-off and landing – as an airplane; control modes – automatic/semiautomatic

Intellectual property protection status

8 patents of Ukraine on utility model have been obtained

Key benefits of invention

UAC M-7V5 has high flight characteristics, which are favorable for air strip with lining / high-level aerodromes; twin-engine provides high flight reliability; the tail beam deviates and provides small dimensions of the UAC in the transportation position; modular construction allows quick obtaining of information of UAC modifications. Taking into account the low probability of failure of two power units at the same time, the UAC M-7V5 is much more reliable than single-engined UAC such as AAI Shadow 400 (USA), IAS Raffaello (Italy) etc.

Market demand

The capacity of Ukrainian market for M-7V5 constitutes 10-15 complexes, part of which may be used by civil airlines and another part by special services. Specified lifetime of the UAC is 6 years before major repairs. The world market may provide a capacity of 150-200 complexes, depending on UAC M-7V5 necessary modifications

Standby status

UAC M-7V5 is undergoing a procedure of obtaining the aircraft certificate of MS type



Scientific and Production Centre of Unmanned Aviation “Virazh”

1, Kosmonavta Komarova ave., Kyiv, 03058, Ukraine
e-mail: nvcba@nau.edu.ua, <http://uav.nau.edu.ua/>, tel.: (044) 406-71-47, Tel./fax: (044) 406-71-54



MULTIENGINE UMMANED HELICOPTER FOR CARGO TRANSPORTATION PKM-14 «SATURNIA»

Purpose of invention and sphere of application

PKM-14 «Saturnia» is an unmanned aircraft intended for small cargo transportation in automatic mode. The potential users of the UAC are civil aviation companies and other civil users

Essence of invention

Technical characteristics: characteristic feature – rotation of engine units bodies into transport position; type of control system - automatic, with preliminary flight planning; take-off/landing - on a landing gear, removing during the flight; payload weight- up to 2 kg; radius of action - up to 3 km; maximum speed on the route - 30 km/h; operational height – up to 500 m; aerodynamic scheme - 4 electric power units

Intellectual property protection status

1 patent of Ukraine on utility model has been obtained

Key benefits of invention

UAC PKM-14 Saturnia benefits are the integrated fuselage, in which bearing rays are combined, a compartment for electronic equipment, an onboard battery compartment and a payload compartment. Considering its properties, PKM-14 Saturnia is an automatic device for commercial networks servicing. There are no analogues in the world. Multicopters made by the "Amazon" company

Market demand

The market for UAV PKM-14 Saturnia is a global one. However, it is necessary to perform appropriate experimental exploitation in order to prove that. Potential users will be the companies servicing retail network stores of packaged goods with weight up to 2 kg

Standby status

Stage of implementation: flight tests of the prototype are carried out



Scientific and Production Centre of Unmanned Aviation “Virazh”

1, Kosmonavta Komarova ave., Kyiv, 03058, Ukraine

e-mail: nvcba@nau.edu.ua, <http://uav.nau.edu.ua/>, Tel.: (044) 406-71-47, tel./fax: (044) 406-71-54



MULTI MISSION DOUBLE ENGINED CONVERTIPLANE NAU-KM 3 "KUBOK"

Purpose of invention and sphere of application

The convertiplane NAU-KM 3 "Kubok" is a double engined vehicle of MS 3500 kg class with rotary external screw on the wingtips. This type of aircraft performs vertical take-off and landing, that allows to perform flights in hard-to-reach geographic and climatic zones, including areas with complex landscape, mountainous areas, islands, polar zones, tropics, etc. The multi mission aircraft can be involved in geological exploration, patrolling of oil, gas pipelines and other linear objects; it also can be used for various types of aerial photography, for the delivery of humanitarian aid, protection of state borders, transportation of patients within hospitals and specialized medical centers, during irregular commercial flights, and also for the wide range of works in disaster areas, fight against piracy, protection of national waters and fisheries, control and preventing smuggling operations, etc.

Essence of invention

Project technical characteristics of the convertible aircraft: max. take-off mass - 3500 kg; payload mass-850 kg; fuel mass – 850 kg; max. speed – 500 km/h; flight duration – 5 h; technical range – 2100 km; number of passengers - 1 pilot + 5 passengers; ferry range - 2900 km; flight altitude – up to 6000 m

Key benefits of invention

For today the 3500 kg class of vehicle is not occupied by any convertible aircraft in the world, therefore the competitive environment is favorable

Intellectual property protection status

1 patent of Ukraine on utility model has been obtained

Market demand

The world market can produce about 500-700 units of KM 3 "Kubok" to meet the needs in the local civil aviation airlines

Standby status

The project is at stage of "technical proposal" according to State Standard of Ukraine 3974-2000. In addition, there is a business plan for obtaining samples of KM 3 "Kubok" for the KM 3 "Kubok" certification as a type of aircraft in the State Aviation Administration of Ukraine

Scientific and Production Centre of Unmanned Aviation "Virazh"

1, Kosmonavta Komarova Ave., Kyiv, 03058, Ukraine

e-mail: nvcba@nau.edu.ua, <http://uav.nau.edu.ua/>, Tel.: (044) 406-71-47, tel./fax: (044) 406-71-54



MULTIPURPOSE DRONE WITH AUTOMATIC IDENTIFICATION OF OBJECTS ON THE TERRAIN

Purpose of invention and sphere of application

The essence of the development is the creation of a multipurpose unmanned aerial vehicle (UAV), which is intended for intelligence purposes and patrolling of the specific area of land or border, recognition, identification and determination of coordinates of objects interest

Essence of invention

- flight height 5-800 m;
- number of detected objects - up to 1000;
- monitoring time of 1 km² area - 45 min;
- maximum working time without recharging - 45 min;
- camera works in infrared light with infrared illumination

Intellectual property protection status

1 patent of Ukraine has been obtained

Key benefits of invention

Developed information-cost technology implementation provides the possibility to increase the accuracy of objects identification and to reduce the energy costs of on-board systems during the flight, which increases the autonomy of the UAV work.

Benefits of the innovation:

- there are no analogues in Ukraine;
- ability to identify objects in automatic mode;
- wide range of implementation (military intelligence, search and rescue works, protection of object, aerial photography);
- relatively low cost

Market demand

The development can be used for controlling of relocation of people, equipment, for identification of animals (tagged) and military intelligence

Standby status

Experimental-industrial prototype has been designed

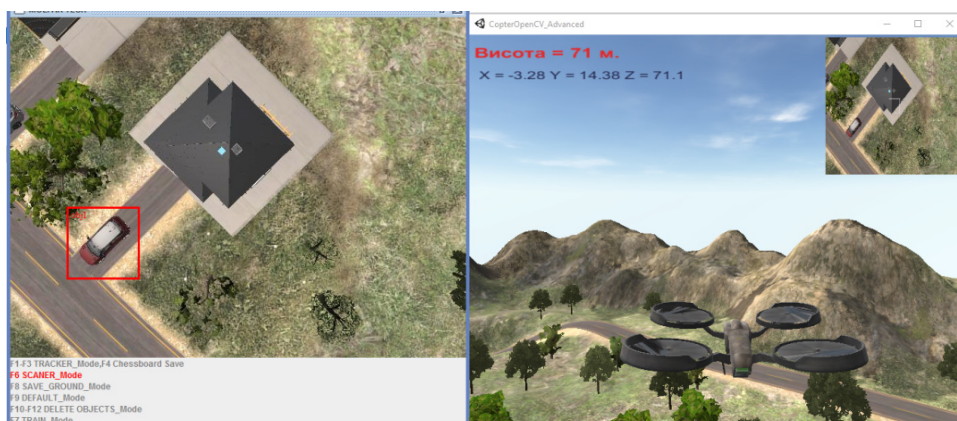

Example of object recognition algorithms by using of UNITY 3D

R&D Department, Centre of Scientific, Technical and Economic Information

2 Rymaskoho-Korsakova str., Sumy, 40007, Ukraine

e-mail: dkurbatov@sumdu.edu.ua, info@cni.sumdu.edu.ua, Tel. (0542) 68-78-69, (0542) 33-41-08



MULTI MISSION UNMANNED AERIAL COMPLEX M-6-3 "ZHAYVIR"

Purpose of invention and sphere of application

The unmanned aerial complex M-6-3 "ZHAYVIR" is intended for aerial photography, video monitoring in the real time, patrolling of the linear and areal objects, and urgent transportation of small cargoes. The potential users of the unmanned complex are civil aviation companies, force and special-task structures of Ukraine

Essence of invention

The unmanned aerial complex M-6-3 "ZHAYVIR" is an aerodynamically completed aircraft based on a conventional scheme, with a wing, in which the profiles with aerodynamic quality up to 160 units are implemented. The V-tail empennage, the performance of deep fissures between the wing and the fuselage, and the correspondent boning of the protruding parts provide the possibility to achieve aerodynamic quality on the cruise efficiency up to 18-20 units. Main technical characteristics of UAV: take-off mass - up to 17 kg, payload - up to 4 kg, max. speed– 160 km/h, flight duration– up to 5 h, range of action– up to 80 km, max. flight height– up to 3000 m, taking-off/landing type – wheeled. UAV control mode is automated/semi-automated

Intellectual property protection status

6 patents of Ukraine on utility model have been obtained

Key benefits of invention

The benefits of development are well-developed aerodynamics that leads to significant fuel economy, increased resource of the propeller engine, excellent maintenance on the line of the given path, increased wind resistance that expands the boundaries of "all-weather" flight property. The UAV M-6-3 "ZHAYVIR" models were delivered to the force structures of Ukraine in the ATO zone in 2015. The world analogues of UAV are unmanned aerial vehicles Pointer (USA), LUNA (Germany), Rafael Sky Lite B (Israel)

Market demand

Ukrainian market has a capacity for M-6-3 within the limits of 30-70 complexes, part of which can be used by civilian airlines and another part by special services. The global market can provide a capacity of 500-700 complexes depending on the necessary UAV M-6-3 modifications

Standby status

Several prototypes have been manufactured and successfully tested; appropriate procedures for the certification of the aircraft type take place in the SAS of Ukraine



Scientific and Production Centre of Unmanned Aviation "Virazh"

1, Kosmonavta Komarova ave., Kyiv, 03058, Ukraine

e-mail: nvcba@nau.edu.ua, <http://uav.nau.edu.ua/>, Tel.: (044) 406-71-47, Tel./fax: (044) 406-71-54



UNMANNED AIRPLANE WITH WHIRL GENERATORS ON THE WING AND CONTROL PANEL

Purpose of invention and sphere of application

Unmanned airplane with whirl generators installed on the wing and control panel have the capacity to fly at large attacked angles without stalling, which makes it suitable for usage during the unfavourable weather conditions (high turbulence, gusts). Sphere of aircraft application is similar to the traditional unmanned vehicles: observation, intelligence, management of ground, military applications

Essence of invention

With the help of whirl generators of a special volume form, which provide predicted place of the whirl emergence, the aerodynamic characteristics significantly improve at the large attacked angles. The critical attacked angle of the aircraft type L-39 was increased from 19° to 35° , which protects the model from stalling during wind gusts, eliminates static hysteresis and autorotation of the model at critical attacked angles, improves controllability of the model with the help of diving-plane and ailerons, increases the efficiency of flap. The whirl generators prevent early flow separation on an aerodynamic controlled nose surface in the arrangement of the "canard" type, which increases the aerodynamic quality of "flying wing" + "canard" type

Key benefits of invention

Possibility of increasing the critical angle of an unmanned aircraft attack to 35°

Intellectual property protection status

5 patents of Ukraine have been obtained

Standby status

Experimental prototype of the unmanned airplane was developed and dynamics of the flight radio-controlled model with a whirl slats was researched

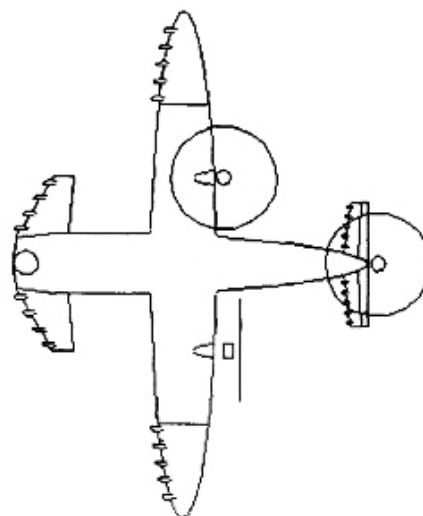

Scheme of the unmanned airplane with whirl generators

Department of Scientific and Technical Information

1, Kosmonavta Komarova ave., Kyiv, 03058, Ukraine

e-mail: nvcba@nau.edu.ua, <http://uav.nau.edu.ua/>, Tel.: (044) 406-71-47, Tel./fax: (044) 406-71-54



TRAINING UNMANNED AIRCRAFT M-22D “AEROTESTER”

Purpose of innovation and sphere of application

M-22D "Aerotester" - is a training unmanned air vehicle (UAV) designed for external pilots' training. The basis of the development are the results of the research on the training of external pilots and other personnel for unmanned aircraft CA, as well as the need for a relatively cheap means of lifting the experimental aircraft instruments and systems. Potential users of UAV are Flight Training Organizations (FTO) for the training of external UAV pilots. UAV M-22D "Aerotester" can be used by organizations as a flying laboratory

Essence of invention

Maximum Takeoff Weight (MTOW) – up to 21 kg; all-weight disposable load – 8 kg; maximum achievable speed – 160 km/h; maximum flying height – up to 5000 m; engine type – petrol-powered 2-stroke engine, starter motor (SM); radius of action – 20 km; endurance – 1 year; demand mode – automatic/semiautomatic; launch and landing technique – as in aircraft

Key benefits of invention

The advantage of the M-22D “Aerotester” – is its complete realistic flight playback of a twin-engined unmanned aircraft that is attractive to aviation training organizations. The consumption of fuel and lubricants, along with this, is 4-5 times less than the real samples of UAV have. According to wing-flap system, flight control surface, undercarriage stowage and other different systems, M-22D “Aerotester” completely complies with “Sky Patrol” class of UAV

Intellectual property protection status

2 patents of Ukraine have been obtained

Market demand

The market for twin-engined UAV is not developed enough because of the primary formation of civil airlines – UAV Operators, and accordingly, with the lack of proposals for the aircraft. The procurement of M-22D to Ukraine may be around 5-10 units

Standby status

Implementation stage: exploratory research



Scientific and Production Centre of Unmanned Aviation “Virazh”

1, Kosmonavta Komarova ave., Kyiv, 03058, Ukraine

e-mail: nvcba@nau.edu.ua, <http://uav.nau.edu.ua/>, Tel.: (044) 406-71-47, Tel./fax: (044) 406-71-54

9. Healthcare

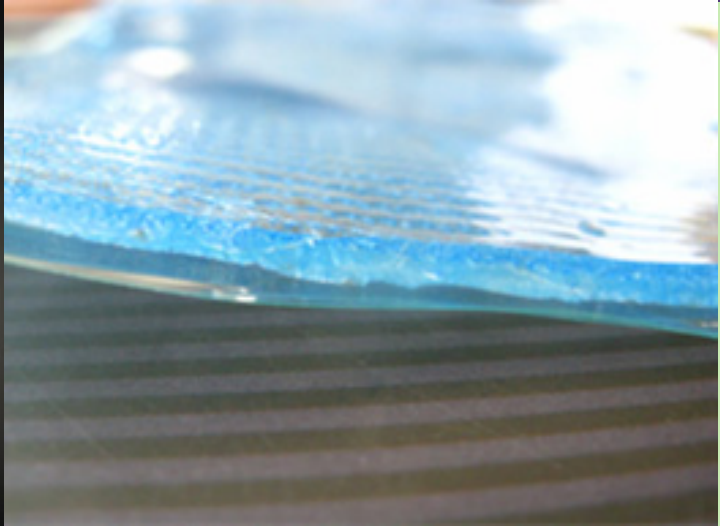



METHOD OF ASSESSMENT OF THE IMPACT OF ELECTROMAGNETIC-FIELD AND HAZARDOUS SUBSTANCES ON HUMANS

Purpose of invention and sphere of application

The method is designed to assess the impact of adverse environmental factors on a human body through the assessment of their impact on the cell state of the body

Intellectual property protection status

2 patents of Ukraine have been obtained

Market demand

The invention is commercially successful. There are no analogues in the world

Standby status

Research sample has been designed

Essence of invention

Principle of the method constitutes the monitoring of individual cells response of buccal epithelium (cheek epithelium) of a person, withdrawn from human body, to the action of environment hazards. Environment hazards can be both electromagnetic fields and environmental chemicals. The cell responds to the environment hazards influence by generating the heterochromatin granules in the nucleus of the cell, which can be seen in a light microscope and evaluated upon the coloring of the orcein (picture). After evaluating the number of the heterochromatin granules in 30-cell nucleus, the average indicants and statistical uncertainty should be determined. The number increase of the heterochromatin granules in the nucleus is a quantitative characteristic of negative influence of environment on the cell and consequently on a human body. Implementation of the method is simple and short – analysis of one sample of cells (30 nuclei) lasts 15-20 minutes. Sampling of cells can be performed in real-life conditions with further study in the laboratory

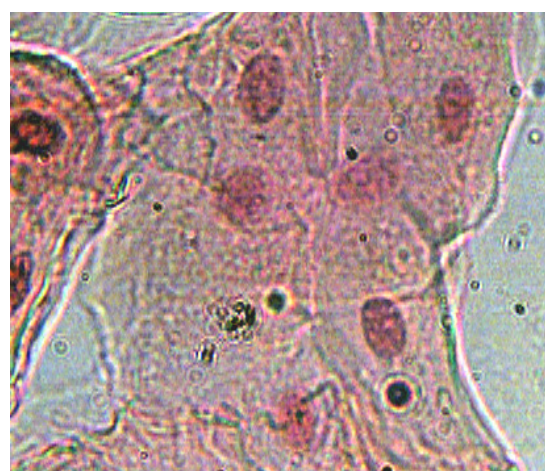
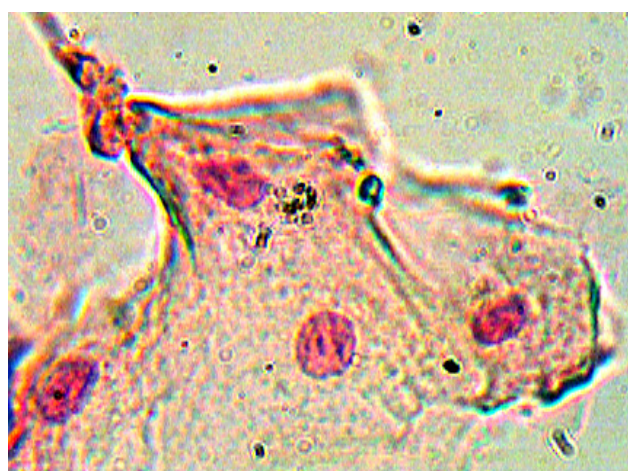

Innovation Centre

6 Svobody sq., Kharkiv, 61022, Ukraine

e-mail: innovation@karazin.ua, <http://innovation.karazin.ua>, Tel /fax: +38(057) 705-52-89



CELLULAR BIOSENSOR FOR DIAGNOSIS OF HUMAN AUTOIMMUNE PATHOLOGIES

Purpose of invention and sphere of application

The biosensor is designed for determining trace amounts of cytotoxic factors in blood serum. It can be used in the institutions of the Ministry of Healthcare of Ukraine

Intellectual property protection status

1 patent of Ukraine has been obtained.

Market demand

The invention is commercially successful on the Ukrainian market

Standby status

Exploratory prototype has been developed

Essence of invention

The high-strung cellular biosensor has been developed to detect the presence of low concentration cytotoxic compounds in the patient's body (which are difficult to detect by analytical methods). The presence of these cytotoxic compounds in the body triggers a range of immunological reactions that lead to the formation of pathologies, in particular myasthenia. The principle of the diagnostic method is based on the fact that cytotoxic compounds react to the cellular biosensor and lead to changes in its characteristics. The results are processed according to the developed program, and on this basis the conclusion is made on the presence of autoimmune pathology and the stage of its development. Testing time takes from 30 to 60 minutes. It is necessary to have 50 microliters (mql) of the patient's blood serum to carry out the analysis

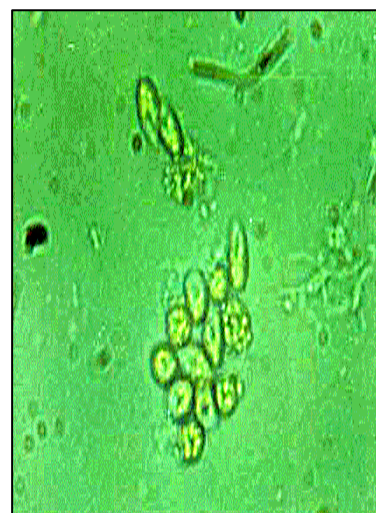
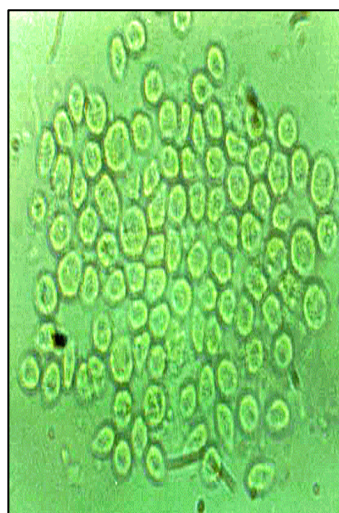
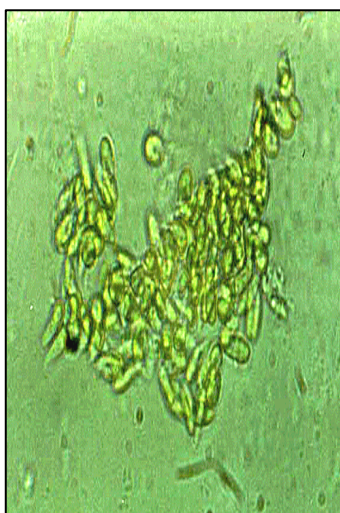

Innovation Centre

6, Svobody Sq., Kharkiv, 61022, Ukraine

e-mail: innovation@karazin.ua, <http://innovation.karazin.ua>, Tel /fax: +38(057) 705-52-89



DEVICE FOR IDENTIFICATION OF LIGAND FORMS OF WHOLE BLOOD HEMOGLOBIN FOR INSTANT DIAGNOSIS OF CRITICAL CONDITION

Purpose of invention and sphere of application

The results of the development can be used in clinical settings and real-life conditions

Market demand

Field of application: medical science, biology and biotechnology, ecology

Essence of invention

The essence of the invention is the use of new approaches to the quantitative assessment of hemoglobin ligand forms and, consequently, the creation of new information technologies, new spectral means for the quantitative assessment of hemoglobin ligand forms in the blood. The developed method of the identification of nitrosyl hemoglobin content along with other five ligand forms (RHb, HbO₂, HbCO, SHb, MetHb) in a sample of peripheral blood will enable the diagnosis of various critical conditions (CO toxication, nitrates, and nitrites, other exogenous compounds)

Standby status

Combined absorption spectrum for nitrosyl hemoglobin in 450-750 nanometers (nm) wavelength interval has been received on the statistical batch data basis out of the deoxyhemoglobin absorption spectrum and its complete transition to nitrosyl form. Millimolar extinction coefficient of nitrosyl hemoglobin in the specified wavelengths interval has been calculated. The results of these studies may become a background for designing an automatic device that can simultaneously identify 6 hemoglobin ligand forms in a sample of blood

Intellectual property protection status

1 patent of Ukraine on utility model has been obtained

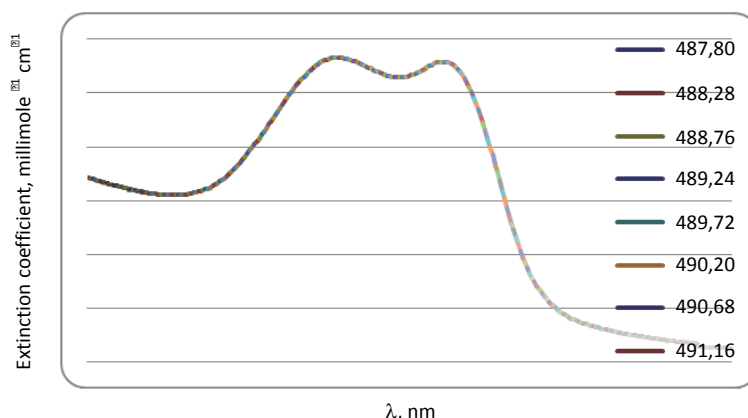

The absorption spectrum for nitrosyl hemoglobin blood of healthy donors built according to millimolar extinction coefficient

Department of Intellectual Property

1, Universytetska str., Lviv, 79000, Ukraine

e-mail: a_pryimak@lnu.edu.ua, <http://www.lnu.edu.ua>, Tel: +38(032) 239-43-69



OPTOELECTRONIC COMPLEX FOR IDENTIFYING THE STATE THE PERIPHERAL CIRCULATION

Purpose of invention and sphere of application

The optoelectronic complex is designed for identifying the cardiovascular system microcirculation disorders through monitoring, processing and holding blood vessels photoplethysmogram (PPG) with the help of hardware facilities

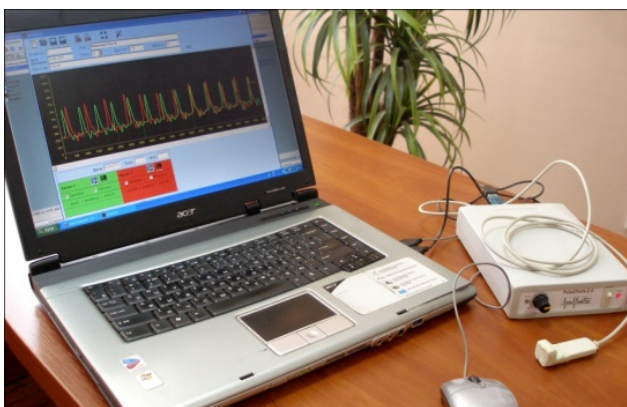

Essence of invention

The use of optoelectronic monitoring biomedical signals sensors, which operate in the infrared and red bands, provides a safe and convenient diagnosing of the population physical well-being of different age groups (including very serious patient, for example after an accident, with burns and the like). The complex enables to monitor simultaneously PPG by two channels on peripheral arteries; to perform hardware and software glitch filtering; to measure the amplitude-time characteristics of PPG; to perform parameter accounting of PPG per unit; to operate with patients' database.

Key benefits of invention

The invention enables to increase the accuracy of measuring of hemodynamic parameters of blood content as well as the introduction into devices, which implement this method, the elements of fiber-glass technology and sources with different wavelengths of the probe radiation. It is possible to solve problems of photodynamic research and telemetry of hemodynamic parameters of biological objects accurately

Intellectual property protection status

4 patents of Ukraine on invention have been obtained and 10 patents of Ukraine on utility model have been obtained

Market demand

The invention is commercially successful due to its ability to measure virtually any point on the body, to create the safe working conditions for caretaking personnel, as well as to maintain comfort conditions and quality of medical care

Standby status

The exploratory prototype has been developed, optical and electronic circuits have been put to the test and after that estimated performance has been confirmed.

Department of Intellectual Property

95, Khmelnytske Shose, Vinnytsia, 21021, Ukraine
e-mail: vntu@vntu.edu.ua, http://vntu.edu.ua, Tel: +38(0432) 56-08-48, fax: +38(0432) 46-57-72



COMPUTING SYSTEM FOR PRE-SURGICAL HETEROTROPIA PLANNING

Purpose of invention and sphere of application

The invention is used to abolition various forms of heterotropia, as well as to study the oculomotor structures of a person

Essence of invention

The developed system provides the possibility to determine the coordinates of the anatomical structures on the eye-ball surface, each muscle torques per axis of the Descartes 3D coordinate system. The Descartes and spherical coordinate systems are used here for determining the coordinates of the anatomical structures. It is possible to determine the distance between the anatomical structures in an arc or chordwise in relative units and in millimeters. The additional ophthalmic spherical coordinate system has been introduced. It is possible to determine the rotation angles of the eye-ball in degrees and to predict the need for surgical interference on specific muscle as well as on a muscle group

Key benefits of invention

The invention provides the possibility to predefine the eye-ball final position at a recession or resection of oblique and rectus muscles.

Intellectual property protection status

3 patents of Ukraine have been obtained

Market demand

Such computing systems can be supplied to all regional and district hospitals

Standby status

The exploratory prototype has been developed which is used in Kremenchuk municipal children's hospital

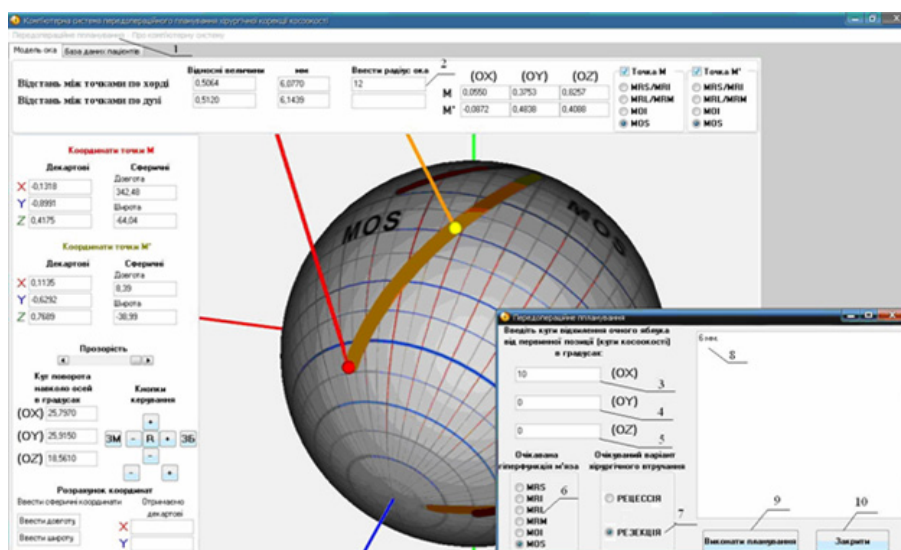

R&D Department

20, Pershotravneva str, Kremenchuk, Ukraine, 39600
e-mail: nich@kdu.edu.ua, <http://www.kdu.edu.ua>, Tel./fax: +38(05366) 3-62-17



HOLOGRAPHIC MACULOSTIMULATOR

Purpose of invention and sphere of application

The invention is intended for vision training and its improving in amblyopia ("lazy eye" syndrome). It can be applied in the institutions of the Ministry of Healthcare of Ukraine

Essence of invention

A holographic maculostimulator, a new device for the effective treatment of amblyopia, including in children from an early age, has been created on the basis of the holographic model of physiological optics developed in the laboratory of radio and optical holography. Maculostimulator original design provides rapid alternation of 3D images which stimulate the macular area of retina. Photostimulation of the sore eye occurs throughout the range of spatial frequency – that is from the lowest to the highest ones. Furthermore, natural white light is used for not creating the threat of traumatic influence on the patient's eye. Treatment procedures can be performed both in specialized rooms in hospitals and in domestic conditions.

Key benefits of invention

There are no similar devices in the world

Intellectual property protection status

The patent of Ukraine has been obtained

Market demand

The invention is commercially successful on the Ukrainian market

Standby status

The exploratory prototype has been developed



R&D Department

2, Kyrpychova str., Kharkiv, 61002, Ukraine

e-mail: nti@kpi.kharkov.ua, <http://www.kpi.kharkov.ua>, Tel /fax: +38(057) 707-62-13



HOLOGRAPHIC VISCONTRASTOMETR

Purpose of invention and sphere of application

The invention is intended for vision diagnostics and correction. Holographic visconstrastometr is a unique and effective device that can be applied in the field of ophthalmology for vision diagnosis and correction

Essence of invention

A holographic visconstrastometer, a new device for effective diagnostics of ophthalmic diseases and vision correction, has been created on the basis of the developed holographic model of physiological optics. The holographic visconstrastometer, due to its distinctive design, enables to accelerate and make a more informative examination process of the entire visual tract, to detect such serious diseases as glaucoma, optic neuritis, optochiasmatic arachnoidite etc. The use of a dynamic hologram in the invention provides a unique possibility for testing and treatment procedures in such serious diseases as leukoma, cataract and opacity of vitreous body that cannot be performed now within existing conservative ophthalmologic techniques

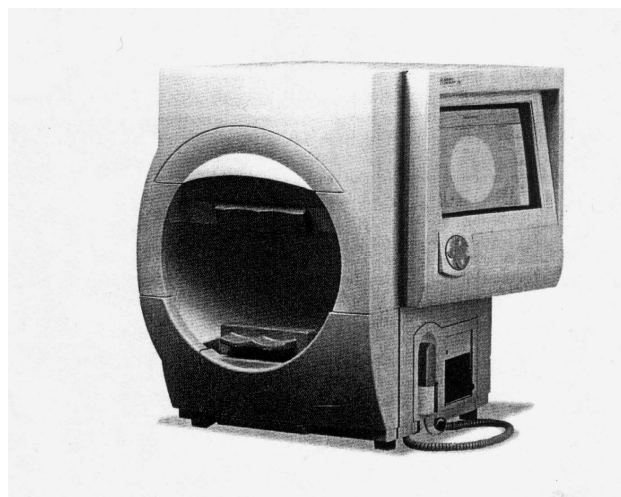

Intellectual property protection status

1 patent of Ukraine has been obtained

Market demand

The invention is commercially successful on the Ukrainian market

Key benefits of invention

There are no similar devices designed

Standby status

The exploratory prototype has been developed

R&D Department

2, Kyrpychova str., Kharkiv, Ukraine, 61002
e-mail: nti@kpi.kharkov.ua, <http://www.kpi.kharkov.ua>, Tel/ fax: +38(057) 707-62-13



HARDWARE-SOFTWARE COMPLEX FOR BRAILLE IMAGES EVALUATION

Purpose of invention

Hardware-software complex is intended to equip the workplace at a quality-control area with the view to objectively evaluate the quality of the Braille font insertion, its compliance with existing requirements and guidelines for printing form production and finished printing (packaging) products

Essence of invention

The complex consists of such units as: an optical module and lighting control system in the visible and infrared ranges. The complex includes the appropriate software applications: the program for input and saving images and the program to calculate the parameters of Braille font

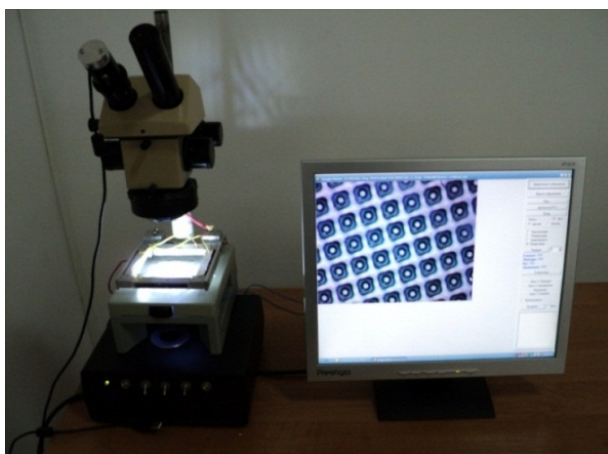

Hardware-software complex overview for parameter measurement of Braille font

Market demand

The device provides the possibility to provide quality control at all stages of the Braille font insertion with the help of the hardware-software complex, which provides a reliable perception to people with visual impairments of the Braille font on the printed (packaging), and other types of products

Standby status

The exploratory prototype has been developed and appropriate applications have been coded.

Intellectual property protection status

1 patent of Ukraine and 3 certificates for copyright registration (software) have been obtained

R&D Department

19, Pid Holoskom str, Lviv, Ukraine, 79020

e-mail: uad.ndch@gmail.com, <http://www.uad.lviv.ua>, Tel.: +38(032) 242-23-41, +38(032) 252-71-68



METHOD OF MODIFICATION OF MAGNETITE SURFACE WITH NANOPARTICLES

Purpose of invention and sphere of application

The invention concerns nanotechnology field, namely, the methods of obtaining polyfunctional nanocomposites with magnetic, luminescent and electrically conductive properties, and it is possible to use it for obtaining diagnostic materials in medicine, markers of oncological cells, for delivering targeted drugs and electrophoresis materials in particular

Essence of invention

The obtained hybrid nanoparticles of modified magnetite are characterized by simultaneous magnetic (magnetic susceptibility 52–58 sm^3/gr), luminescent (emission bands range is 520–550 nm) and conductive (specific conductance $\sim 6 \times 10^{-2} \text{ sm/m}$) properties

Key benefits of invention

Operation benefit and economic effect of the invention is simplification of the procedure for magnetite nanoparticles surface modification providing them with luminescent and electrically conductive properties

Intellectual property protection status

The application for an invention has been submitted

Market demand

Surface modification of magnetic clusters with functional polymers and luminescent labels enables to control the nanoparticles movement and follow it in the cellular medium and living tissues, which is important for the latest diagnostic methods in medicine and biology

Standby status

The technology of obtaining polyfunctional nanocomposites under the simplified procedure for magnetite surface modification by the adsorption-polymerization method for components optimal concentrations has been developed

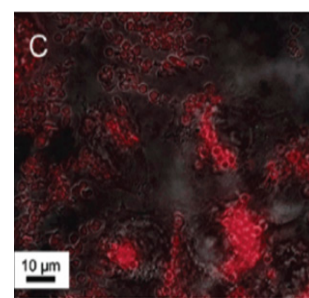
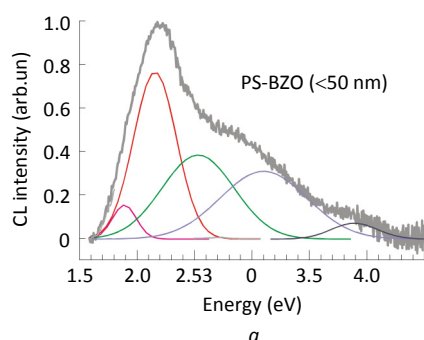

a – composite luminescence spectrum of magnetite-polystyrene BaZrO_3 ; *b* – SEM-image of modified magnetite dispersion; *c* - particles of modified magnetite are attracted by oncological cells, which can be detected by luminescence directly above a magnet

Department of Intellectual Property

1 Universytetska str., Lviv, 79000, Ukraine

e-mail: a_pryimak@lnu.edu.ua, <http://www.lnu.edu.ua>, Tel: +38(032) 239-43-69



PULSE STERILIZER FOR REFINING THE OBJECTS OF DIFFERENT NATURE BY USING THE HIGH-INTENSITY ELECTROMAGNETIC IMPULSES

Purpose of invention and sphere of application

The technology of sterilization with high-intensity electromagnetic impulses and hardware has been developed in order to implement sterilizing bactericidal action on the microflora (Staphylococcus, Salmonella, Klebsiella, Bacterium Koch) in places where it is necessary to ensure a low level of bacterial confluency. This technology can be used in medicine, pharmaceutical, chemical, food industries, urban transport, agriculture, etc.

Essence of invention

The electrophysical method provides wide perspectives for the implementation of highly-effective sterilization, as this method is based on the use of ultraviolet radiation, characterized by a significant bactericidal action. Magnetoplasma compressor is used as a source of ultraviolet radiation, which is the most highly-effective source of impulse action for today. Pulse sterilizer has high-energy capacitive storage and open-type front compressor that allows to keep the part of the hard ultraviolet in the radiation spectrum which is the most harmful to microorganisms.

The control of a prototype sterilizer is performed remotely. The high energy characteristics of the pulse sterilizer have been confirmed, for which, according to the storage capacity of the 300 mcF, the charge voltage of 3 kV and the discharge current of 150-250 kA, ultra-violet emission energy in a pulse of ≤ 25 mcs in the band of bactericidal radiation of 0,12-0,3 mcm is 100-150 J at a plasma temperature of about 10000 K

Intellectual property protection status

2 patents of Ukraine have been obtained

Market demand

The pulse sterilizer improves the processing efficiency compared to the existing methods (based on mercury-quartz lamps) and provides reduced processing time in 10 – 100 times of the refining. Thus, the invention is commercially successful

Standby status

The exploratory prototype and concepts have been developed, as well as the expected characteristics have been confirmed

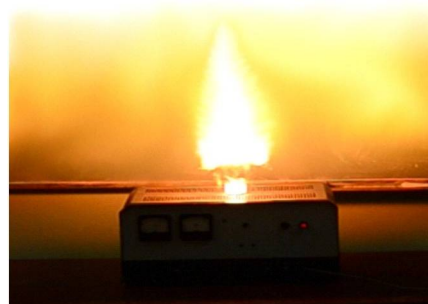

Pulse sterilizer of ultra-violet radiation and "plasma focus"

R&D Department

11 Instytutska str., Khmelnytskyi, 29016, Ukraine
e-mail: centr@khnu.km.ua, <http://www.khnu.km.ua/root/page.aspx>, Tel: (0382) 72-55-88,
fax: (03822) 67-42-65



POLYPROPYLENE SURGICAL BACTERICIDAL MONOFILAMENTS

Purpose of invention and sphere of application

Developed polypropylene (PP) monofilaments with antimicrobial characteristics contain bactericidal agents: polyhexamethyleneguanidine chloride (PHGC) and carbon nanotubes (CNT) or nanoagent combination of silver/silica (Ag/SiO₂). Monofilaments are abreast with foreign counterparts and can be used in surgery as suture materials and for mesh implants manufacturing

Essence of invention

The innovation is designed to create an effective way of modifying PP threads by simultaneously introducing a bactericidal substance and a nanofiller. The use of combined Ag/SiO₂ nanoagents provides a high prolonged antimicrobial action of the products and reduces their toxicity and cost due to silver content reduction. The preclinical studies have shown that the developed monofilaments are characterized by high bactericidal and mechanical parameters as well as good manipulating properties. The content of the CNT/ PHGC and Ag/SiO₂ agents in the filaments is 1.0 / 1.0 and 0.5 % wt. respectively. Tensile strength 510-590 MPa, loop strength – 300-380 MPa, knot strength – 390-440 MPa, breaking extension – 9-12 %, the diameter of growth retardation of S.aureus microorganisms is 12.0-33.0 mm

Intellectual property protection status

5 patents of Ukraine have been obtained



Market demand

The need for suture surgical materials is about 4 million materials per year, and mesh implants (of different sizes) – more than 50 thousand pieces per year. There is no production of antimicrobial polypropylene monofilaments in Ukraine today, which determines the need for their development in the domestic market

Standby status

Temporary process regulation for the surgical suture and retention production has been developed as well as technical specifications

Department of Intellectual Property

2 Nemyrovycha-Danchenka str., Kyiv, 01011, Ukraine

e-mail: nds@knutd.edu.ua, <http://knutd.edu.ua>, Tel/fax: +38(044) 280-16-03



MULTIFUNCTIONAL HARDWARE "BARVA -THERAPIST"

Purpose of invention and sphere of application

Prevention and treatment of the most common human diseases (influenza, myocardial infarction, stroke, Alzheimer's disease, tuberculosis, chronic obstructive pulmonary diseases, cancer) with the help of photonic technologies. The phototherapeutic hardware complex "Barva-Therapist" can be used in clinics, polyclinics, sanatoria, family physician offices, rural medical and obstetric centres, school first-aid posts, offices of doctor in sports medicine as well as at home by the patients themselves

Intellectual property protection status

1 patent of Ukraine has been obtained



Essence of invention

The therapeutic effect of the phototherapeutic hardware complex "Barva-Therapist", which has more than 50 types of devices and their modifications, is based on the ability of visible and infrared light spectrum bands to improve blood and lymph microcirculation, to increase the elasticity of blood vessel walls, to normalize rheological blood parameters, and its oxygen-transport function. The light of the visible and infrared spectrum improves the work of the human regulatory systems (immune, endocrine and central nervous system); it also performs anti-inflammatory, healing, analgesic, radioprotective and photoreactive effect; increases bioenergetic potential of cells; accelerates metabolic process and angiogenesis; regulates arterial tension. The use of photonic apparatus of the complex has no contraindications, shortens the treatment of the most common person diseases in 2-3 times and it does not lead to bad effects. Development has no analogues in the world

Market demand

The invention is commercially successful on the international and Ukrainian markets

Standby status

The invention has already been implemented on the market

Innovation Centre

6 Svobody Sq., Kharkiv, 61022, Ukraine

e-mail: innovation@karazin.ua, <http://innovation.karazin.ua>, Tel/fax: +38(057) 705-52-89



DIGITAL PULSE RECORDER OF HIGH-PROBABILITY REGISTRATION OF PRESSURE PULSE

Purpose of invention and sphere of application

The invention concerns the state diagnosis of the human cardiovascular system, the monitoring and control of arterial pressure and pulse rate, the reading of local and three-dimensional sphygmography for solving the polycardiogram and polysfigmography problems

Essence of invention

Measurement sensor module: dynamic range – 0-300 mm Hg; intrinsic error – up to 0,25%; resolution – is not worse than 0.05 mm Hg; operating temperature range – 10–50 oC. Sphygmograph system: number of channels – 4; the possibility of choosing a single pressure pulse and its contour and spectral analysis; suppression of artifacts; the possibility of the augmentation index determining and the pulse wave propagation rate, as well as determining of the RR-interval variability; logging and creating a survey database; the possibility of joint action with electrocardiographs (within the polycardiogram complex)

Intellectual property protection status

6 patents of Ukraine and 4 patents of the Russian Federation have been obtained

Key benefits of invention

The sphygmograph system differs from its existing counterparts (VaSera-1000, Japan; "Complior-01", France; VICORDER, Germany) by using high-precision piezoelectric sensor of a new generation with interelectrode gap modulation of the resonator excitation, which provides a higher resolution while measuring air pressure at the level of 0.05-0.075 mm Hg. It provides new possibilities for parameter determination of pressure pulse and allows to reveal pathologies of the cardiovascular system in the early stages, which significantly increases the diagnostic value of existing procedures.

Market demand

The sphygmograph system can be used in medical institutions and diagnostic centers for diagnosing the cardiovascular system and identifying preinfarction and stroke syndromes both separately (for example, "Domestic doctor" device) and integrated into the "Cardiologist's workplace"

Standby status

The exploratory prototype and the design documentation have been developed, and the expected characteristics have been confirmed.

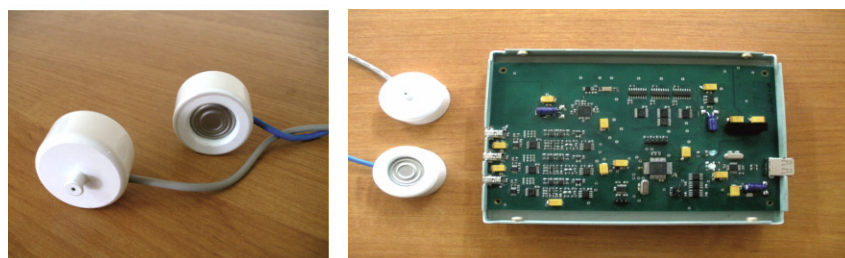

Pressure pulse sensors and digital sphygmograph system

R&D Department

11 Instytutska str., Khmelnytskyi, 29016, Ukraine
e-mail: centr@khnu.km.ua, <http://www.khnu.km.ua/root/page.aspx>, Tel: (0382) 72-55-88,
fax: (03822) 67-42-65



MAGNETIC IMPULSE TREATMENT APPARATUS "MILA – 1"

Purpose of invention and sphere of application

The device is intended for treatment of the lumbar osteochondrosis, knee joint arthritis, arthrosis and arthritis of hip joint, thoracic spine osteochondrosis, sciatic neuritis and neuralgia, inflammatory muscle diseases (initis, soft tissue bruise) etc. Healthcare institutions are the potential users of this invention

Intellectual property protection status

1 patent of Ukraine on utility model has been obtained

Market demand

Apparatus "MILA-1" can be used in regional, municipal and rural hospitals, polyclinics, sanatoria and preventative clinics

Essence of invention

A distinctive feature of the high-intensity method of pulsed magnetotherapy, which is used in the device "MILA-1", is a large magnetic induction (up to 1.2 T), that is ten times greater than the magnetic fields that occur in conventional magnetic therapy devices (0, 5-50 mt), thus, an influence on deep-seated nervous, muscular, bone structures and internal organs is achieved. Adjustable magnetic field amplitude – up to 1200 mt; magnetic field: pulse bipolar field, two pulses in one transmission; pulse duration – 110 mcs; pulse-to-pulse spacing – 80 ms

Standby status

The invention is ready for serial production. A TR Certificate (Certificate of Conformity to Technical Regulations) concerning medical products has been obtained



R&D Department

20 Pershotravneva str., Kremenchuk, 39600, Ukraine
e-mail: nich@kdu.edu.ua, <http://www.kdu.edu.ua>, Tel/fax: +38(05366) 3-62-17



NATURAL ANTIOXIDANTS AND GLYCOSAMINOGLYCAN COMPOSITES AS NEUROPROTECTANT, AND NEUROREGENERATION STIMULATORS

Purpose of invention and sphere of application

The essence of invention lies in the creation of natural antioxidants cocktails in combination with natural glycosaminoglycans (heparan sulfate and hyaluronic acid) with the view to obtain pharmaceutical and food composites for the preventive protection of the nervous system and for regeneration stimulation of nerve cells after injuries

Essence of invention

The essence of the development is to take into account the complex analysis correlation of neuronal adhesive molecules, the main cytoskeleton components of the nerve cells and the brain intercellular matrix. The molecular-biochemical study of effective neuroprotective compounds of natural origin has been carried out and the prevention algorithm of encephalopathies development in conditions of pathologies of different genesis has been developed

Intellectual property protection status

5 patents of Ukraine have been obtained

Key benefits of invention

Unlike existing drugs with antioxidant composition of different genesis, the proposed invention is based on fundamentally new molecular-biochemical data on nerve cell renewal stimulation and reduction of reactive astrogliosis development, with the synergistic action of natural substances of antioxidants and glycosaminoglycans

Market demand

There are no analogues of developed pharmaceutical and nutrimental composites in the world. The results can be implemented in medical, diagnostic, pharmacological and rehabilitation institutions

Standby status

State of completion – 85%, research is being carried out

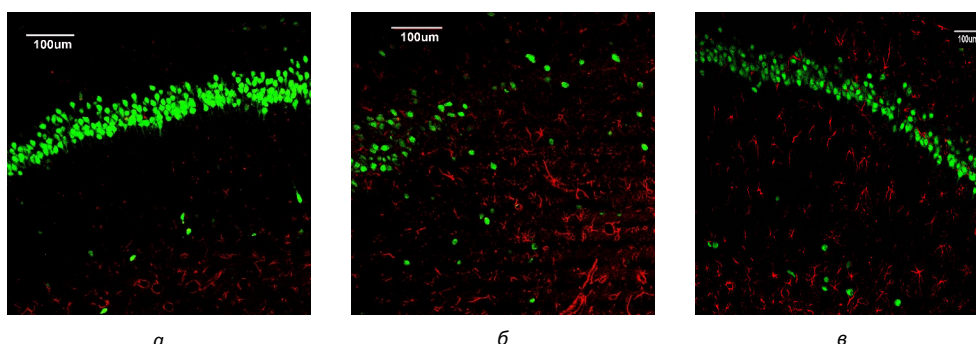

Indicator of neurons recovery (green) and blockage of astrocytes reaction (red) after experimental cerebral ischemia: *a* – norm, *b* – ischemia, *c* – experimental composite treatment

Department of Scientific and Technical Information

72, Haharina ave., Dnipro, 49010, Ukraine

e-mail: ontj_dnu@i.ua, <http://www.dnu.dp.ua>, Tel.: +38(056) 760-93-54



MULTI-LAYERED TRANSDERMIC TREATMENT WRAPS

Purpose of invention and sphere of application

The invention is intended for the creation of medical and prophylactic products: bandaging material, compressive products, patient-care items, and provides antiseptic conditions on open wounds

Essence of invention

The multilayer textile material of a particular design provides moisture absorption from the wound; antiseptic conditions help heal wounds and burns. The products have antimicrobial effect on *S. aureus*, *Escherichia coli*, antifungal effect on *Candida albicans* (about 80-96% of microorganisms die within 24 hours)

Intellectual property protection status

1 patent of Ukraine has been obtained

Market demand

Multi-layered transdermic therapeutic wraps are offered for use in surgical departments of hospitals, clinics, ambulances, etc.

Standby status

The basic technological parameters have been determined and experimental samples have been made. It is possible to start an experimental production

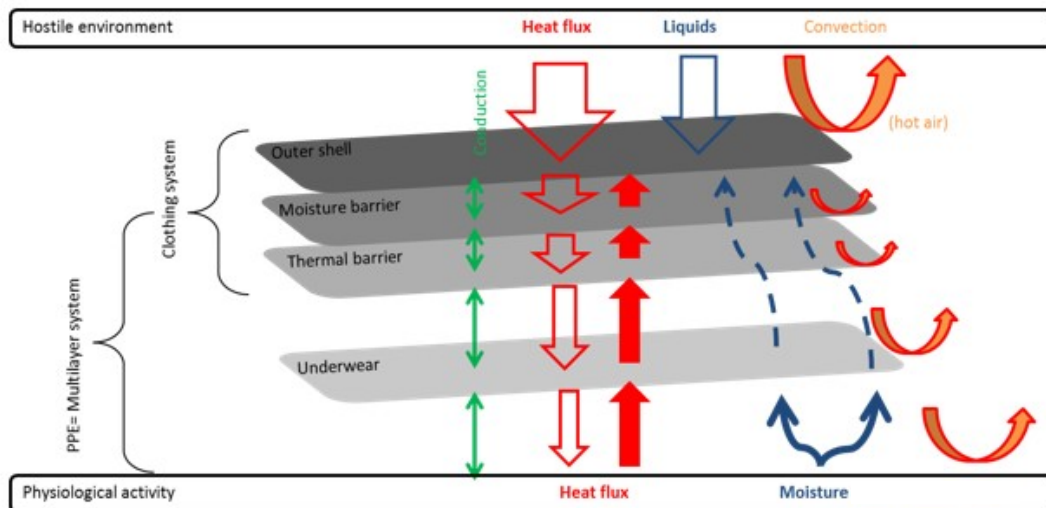

Schematic representation of a multilayered textile composite

Department of Intellectual Property

2 Nemyrovycha-Danchenka str., Kyiv, 01011, Ukraine
 e-mail: nds@knutd.edu.ua, <http://knutd.edu.ua>, Tel./fax: +38(044) 280-16-03



HEMOSTASIS TREATMENT

Purpose of invention and sphere of application

The development can be used to stop bleeding from vessels of different diameters, either during wounds in wartime, in emergency situations or during elective operation in surgery, traumatology, obstetrics and gynaecology

Essence of invention

The essence of the invention is to form a multi-layered gauze bandage, which contains the active substance – chitosan. The contents of chitosan in various ratios and forms makes it possible to significantly increase the efficiency of stopping arterial bleeding from large vessels (femoral and brachial arteries) in comparison with traditional medical devices registered in Ukraine. An additional developed remedy has an antibacterial effect, which can reduce the frequency of purulent infectious complication



Bandage with chitosan

Key benefits of invention

The use of a chitosan bandage makes it possible to reduce the time of stopping a massive bleeding by 2 times, furthermore, the use of freeze-dried sponge decreases the extent of blood loss by 2.9 times, the use of chitosan bandage decreases it by 10 times. Other benefits: simplicity of production, low cost of components, ease of use

Intellectual property protection status

1 patent of Ukraine on invention has been obtained

Market demand

The market attractiveness of the product is due to the high efficiency of development and the absence of counterparts in Ukraine

Standby status

The commercial prototype has been developed and tested

R&D Department, Centre of Scientific, Technical and Economic Information

2 Rymskoho-Korsakova str., Sumy, 40007, Ukraine
 e-mail: dkurbatov@sumdu.edu.ua, info@cni.sumdu.edu.ua,
 Tel/fax: +38(0542) 68-78-69, +38(0542) 33-41-08



DRIED HYDROGEL TREATMENT DRESSING

Purpose of invention and sphere of application

Dried hydrogel treatment dressing is used to treat burn, trophic, post-surgery wounds, as well as to protect the wounds from bacterial and mechanical abnormality. The peculiarity of their application is that in health institution there is a completely dried hydrogel dressing without medicinal preparation. The doctor decides to fill the hydrogel dressing with the appropriate medicine, depending on individual characteristics, patient needs and wound treatment stage

Essence of invention

The strength of the reinforced hydrogel band on the compression is 90-120 kPa with a relative deformation of 85-90%, the strength of a similar unreinforced hydrogel of the same composition is 20-25 kPa. The extension strength is determined by the strength of the polypropylene mesh reinforcing the hydrogel. The reinforced hydrogel fabric does not dissolve and retains the relative strength of the swelling degree about 90-120, while its thickness increases from 4 mm to 15-20 mm. The thickness of the dried hydrogel fabric is 0.1-0.2 mm

Key benefits of invention

The benefits of dried hydrogel dressing are its high physical and mechanical properties, lower cost compared to imported counterparts, ease of use and virtually unlimited longevity

Intellectual property protection status

The invention has been patented

Market demand

Dried hydrogel dressing can be used in medicine, pharmacy and cosmetology

Standby status

A medical technology has been developed, a pilot plant has been manufactured and put into operation, a permit from the Ministry of Health of Ukraine was issued for its use as medical supplies, after which commercial batch has been released

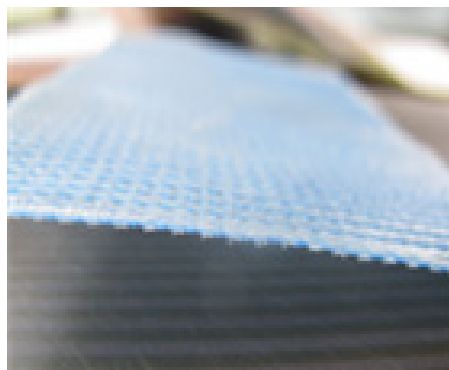

Dried hydrogel dressing

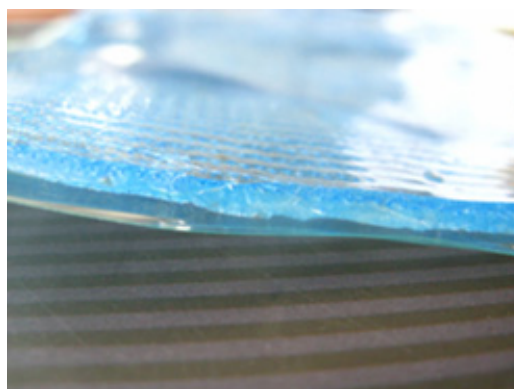

Hydrogel dressing filled with medication

R&D Department, Marketing and Innovation Department

12, Stepana Bandery str., Lviv, 79013, Ukraine
e-mail: transfer@lpnu.ua, <http://lp.edu.ua>, Tel.: +38(032) 258-25-34



BARRIER SURGICAL ENSEMBLES FOR CROSS CONTAMINATION PROTECTION

Purpose of invention and sphere of application

The designed outfit is intended to protect employees of medical and preventive institutions during surgical operations

Essence of invention

The original design of clothes and the selection of textile materials provide convenience and reliable protection against microorganisms. Applied textile materials and accessories provide high wear resistance and preservation of all technical characteristics up to 50 cycles of washing and sterilization. Set Characteristics of surgical clothes are singled out in the Technical Specifications (TS), which are registered in Ukraine properly. The outfit meets the requirements of TSU 18.2-16293843-008: 2011 "Clothes for workers of medical and preventive institutions"



Intellectual property protection status

The technical specifications of Ukraine, developed in cooperation with the manufacturing enterprise, have been obtained

Market demand

The ensembles are provided to the surgical departments of hospitals and ambulances

Standby status

Commercial manufacturing

Department of Intellectual Property

2 Nemyrovycha-Danchenko str., Kyiv, 01011, Ukraine
e-mail: nds@knutd.edu.ua, <http://knutd.edu.ua>, Tel./fax: +38(044) 280-16-03



SPECIAL DANGER INFECTION PROTECTIVE ENSEMBLES

Purpose of invention and sphere of application

The invention is aimed to protect medical personnel from highly infectious disease of the 1st and 2nd degree of pathogenicity (plague, cholera, etc.) and to create safe working conditions for personnel of sanitary and epidemiological stations, veterinary, medical, diagnostic and research centers and laboratories, biological, public and other institutions, while working with biologically-sourced raw materials

Intellectual property protection status

The technical specifications of Ukraine, developed in cooperation with the manufacturing enterprise, have been obtained



Essence of invention

The original design of the outfit and the selection of textile materials provide usability and reliable protection against microorganisms. Applied textile materials and accessories provide high wear resistance and preservation of all technical characteristics up to 50 cycles of washing and sterilization. Set contents: surgical coat, underwear (overalls or pajamas), boot covers, helmet, earloop facemask. The quality of the sets meets the requirements of the State Sanitary Rules (SSR 9.9.5.03599, clause 3.3) and the requirements of the Technical Specifications of Ukraine 18.2-16293843-012: 2013 "Outfits for working with microorganisms of the 1st and 2nd groups of pathogenicity"

Market demand

All sanitary-epidemiological stations of Ukraine and other institutions are being provided by the sets, where personnel work with biologically-sourced raw materials

Standby status

Implemented into commercial manufacturing

Department of Intellectual Property

2, Nemyrovycha-Danchenka str., Kyiv, Ukraine, 01011
e-mail: nds@knutd.edu.ua, <http://knutd.edu.ua>, Tel./fax: +38(044) 280-16-03



SUIT FOR PEOPLE WITH SPINAL INJURY

Purpose of invention and sphere of application

The invention is intended for people with spinal injuries, which can move with the help of a wheelchair, and can be used in medical and rehabilitation institutions for patients with musculoskeletal disorders

Intellectual property protection status

1 patent application on utility model has been submitted

Market demand

Since the main causes of the disability spread are wars and battles in areas of armed conflict, outfits for people, who use wheelchairs are currently in demand on the market of Ukraine

Essence of invention

In the design and material selection of the sports suit, changes in the structure of the human body after spinal injury, physiological features of the organism, caused by the disease, and the specificity of the operation conditions are taken into account. The lower part of the sleeves is detachable with a zipper, the back of the sports jacket is extended and heat-insulated; sleeves have wear-resistant lining. Trousers do not have a middle back seam, with outsized rise, the size in knee area has been increased, pockets are hidden in the seam. All these things provide usability and aesthetic appearance while keeping a person in a wheelchair

Standby status

The obtained prototypes have successfully undergone tests



Department of Intellectual Property

2 Nemyrovycha-Danchenka str., Kyiv, 01011, Ukraine

e-mail: nds@knutd.edu.ua, <http://knutd.edu.ua>, Tel /fax: +38(044) 280-16-03



MASSAGE INSOLES AND SHOES

Purpose of invention and sphere of application

The message of the feet reflex zones with the help of the product is applied in the complex therapy of treatment and prevention of various human diseases, including static deformation of the feet and cardiovascular diseases

Essence of invention

According to the study results of the load distributing on the feet plantar surface while using massage insole and shoes with a filler in the form of fruit plants seed, the absence of a violation of the human body position has been established. The use of fruit seeds, mainly of cornel or cherry, makes the insole light, natural with the possibility of plantar deformation and capable of rapid accumulation of human heat.

The rate of hygienic properties of the invented insoles and shoes: air-proof – $2,6 \text{ mg/sm}^2\cdot\text{h}$; breathability – $102,3 \text{ dm}^3/\text{m}^2\cdot\text{c}$ under 50 Pa of pressure and $189,5 \text{ dm}^3/\text{m}^2\cdot\text{c}$ under 100 Pa of pressure; water absorption 4,6 %, which completely conforms with the norms and proves the creations of comfortable conditions for consumers.

Key benefits of invention

According to the study results of the load distributing on the feet plantar surface while using massage insole and shoes with a filler in the form of fruit plants seed, the absence of a violation of the human body position has been established. The use of fruit seeds, mainly of cornel or cherry, makes the insole light, natural and capable of rapid accumulation of human heat



Intellectual property protection status

3 patents of Ukraine and 1 patent of the Russian Federation have been obtained

Standby status

The invention has obtained positive expert review of the vocational and labour rehabilitation laboratory of the State University "Chebotarev State Institute of Gerontology of the NAMS of Ukraine"

Department of Intellectual Property

2 Nemyrovycha-Danchenka str., Kyiv, 01011, Ukraine
e-mail: nds@knutd.edu.ua, <http://knutd.edu.ua>, Tel./fax: +38(044) 280-16-03

10. Environment management





TECHNOLOGY OF CREATING DSS (DECISION SUPPORT SYSTEM) FOR INTEGRATED WATER RESOURCES MANAGEMENT OF THE RIVER BASIN OR REGION

Purpose of invention and sphere of application

The technology is designated for collecting and consolidating on the basis of a unified information model of data on water resources and water management facilities of a river basin or other region (a country, a region, a district) and creation of decision support systems (DSS) based on it for integrated water resources management of the basin of this river/region

Essence of invention

The technology allows maximum integration and harmonization of various data on water resources and water management facilities. It supports a high level of interoperability and automation of data processing. The models, methods, algorithms and standard software have already been developed at the level of the best world standards.

Local automated workplaces can be installed on an arbitrary number of computers without the purchase of additional keys, without violating the legislation (a special GIS technology is used for their creation). Web systems use free software. It is possible to import from most departmental industry systems and export in known data formats. The system requires the OS Windows and MS Excel

Intellectual property protection status

30 certificates of registration of copyrights for work on individual modules and systems have been obtained

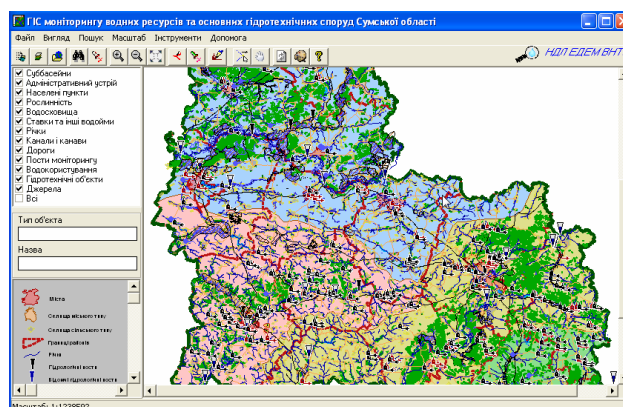

Local automated workplace of the system

Market demand

Technology can be used by any country or countries. The creation and implementation of such systems is dictated by the EU Water Framework Directive, which is obliged to implement all EU countries and countries that have signed the Association Agreement with EU

Standby status

The technology has already been tested in projects by financing of the UNEP, UNDP, EC, OSCE, GEF, SIDA, including the EU countries and Ukraine. Individual DSS are implemented in the Republic of Moldova and in all regions of Ukraine. For each river basin and region, certain adaptation of the DSS is carried out

Department of Intellectual Property

95, Khmelnytske Shose str., Vinnytsia, Ukraine
e-mail: vntu@vntu.edu.ua, Tel.: (0432)56-08-48; Fax: (0432) 46-57-72



IMPLEMENTATION OF INNOVATIVE TECHNOLOGIES OF BIOMELIORATION ON WATER BODIES OF GENERAL USE FOR INCREASING QUALITY OF WATER RESOURCES IN UKRAINE

Purpose of invention and sphere of application

The technology is aimed at the use of an environmentally safe, self-funding method of water purification with the help of integrated use of hydrobionts and biomeliorants. Potential customers of technologies can be the State Agency of Water Resources of Ukraine, the State Fisheries Agency of Ukraine, the State Agency for Energy Efficiency and Energy Conservation of Ukraine, the Ministry of Environment and Natural Resources, the Ministry of Energy and Coal Industry of Ukraine, the Ministry of Agrarian Policy and Food of Ukraine

Essence of invention

On the basis of tested technology, the complex application of herbivorous hydrobionts and biomeliorants with their further protection and normalized taking out have been proposed. The number and species composition of herbivorous hydrobionts that are inoculated have been scientifically calculated

Key benefits of invention

The technology is unique and has no analogues in Ukraine. The increase up to 25% transparency of water, use of surplus phyto- and zooplankton, soft aquatic vegetation, enhancement of water storage is due to biomelioration. Such results have already been received today on Dnipro-Donbas canal. The proposed technology provides significant improvement in the quality of water resources, throughput capacity of the canal. Cost reduction of electricity to pump water in the canal reached 12 %



Increasing quality of water on Dnipro-Donbas canal
by means of biomelioration

Intellectual property protection status

New technology is protected with the patent of Ukraine

Market demand

In Ukraine, there is a significant deterioration in the quality of water bodies of general use, including the main canals that deliver technical and drinking water in the eastern and southern regions of the country. The growth of water bodies leads to a shortage of water for the needs of population and industry, so the continuity of service of the canals is urgently needed

Standby status

It has been implemented as a pilot project of the innovative technology of biomelioration on Dnipro-Donbas canal (State Agency of Water Resources of Ukraine)

R&D Department

25, Serhiia Yefremova str., Dnipro, Ukraine, 49600

e-mail: nauka_ddau@ua.fm, <https://www.dsau.dp.ua/>, Tel.: +38(056) 713-51-75



PYROLYSIS PLANT FOR WASTES RECYCLING

Purpose of invention and sphere of application

The pyrolytic method of utilization of domestic, medical and industrial wastes allows to utilize waste for the environment efficiently, with minimal economic and technological costs for utilization, as well as subsequent efficient use of thermal energy

Intellectual property protection status

5 patents of Ukraine have been obtained

Market demand

These products can find application in medical institutions and utilities, domestic enterprises, which transport and bury waste products at landfill sites

Essence of invention

The most important indicator is that during pyrolysis the organic fraction undergoes preliminary decomposition in anoxic medium, after which the resulting concentrated vapor-gas mixture is sent to a post-combustion chamber where, in the controlled combustion of gas-producing products, toxic substances are transferred to be less or completely safe. The main advantage of this development, along with such a well-known installation is a high efficiency, as well as a low manufacturing cost. Capacity utilization of the pyrolysis installation is 200 kg / h, the amount of heat generated is 0.3 Gcal / h, the maximum permissible level of emissions within the limits

Standby status

An experimental sample has been developed, design schemes are worked out, planned characteristics are confirmed, and design documentation has been developed



Department of Intellectual Property

95, Khmelnytske Shose str., Vinnytsia, Ukraine
E-mail: vntu@vntu.edu.ua, Tel.: (0432)56-08-48; Fax: (0432) 46-57-72



FOOD INDUSTRY WASTES UTILIZATION

Purpose of invention and sphere of application

The technology solves the problem of utilization of alternative «renewable» resources – food industry waste – in the processes of sorbent production for alcoholic beverages production and water treatment systems, as well as utilization of products for processing oak wood waste for wine and cognac production

Essence of invention

Methods for processing food industry wastes for obtaining carbon sorption materials, as well as products of processing of oak wood, have been developed. Optimal conditions for obtaining products of processing raw materials with a large yield, a specified fractional composition, and a developed pore space were determined. Conversion of pyrolyzed wood waste into adsorbents is a method of chemical activation, the investigation of a porous structure is a method of adsorption-desorption of nitrogen

Key benefits of invention

The main advantages of the obtained sorbents and the conditions of their production are the following: low cost; low energy consumption during activation; environmental friendliness in the process of impregnation. Energy-saving ways of utilization of food industry waste which allow producing cheap sorbents with a developed pore surface, as well as products of wood waste processing with a large yield and acceptable fractional composition are suggested

Intellectual property protection status

Technical solutions are protected with 8 patents of Ukraine

Market demand

Domestic production of sorbents in Ukraine does not satisfy internal needs. Alternative raw materials for the production of sorption materials might be pyrolyzed wood waste generated in the process of smoking food products

Standby status

The results of the pilot testing were implemented in the blending shops and sorting departments of various Ukrainian enterprises with an estimated economic effect of 400 000 UAH/Year

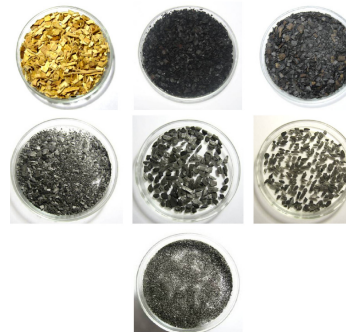
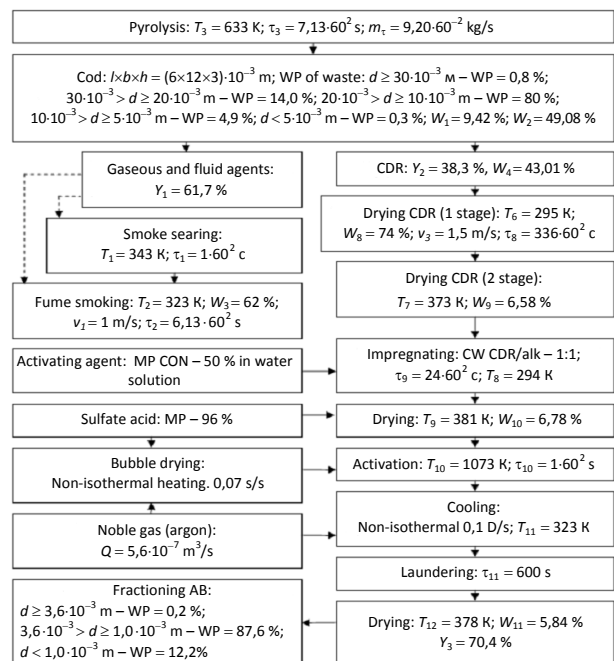

Stages of obtaining sorbent

Department of Intellectual Property

68, Volodymyrska str., Kyiv, 01601, Ukraine
e-mail: info@nuft.edu.ua; www.nuft.edu.ua; Tel: +38(044) 287-94-55



BIOSORPTION AND FILTRATION TECHNOLOGY OF WASTE WATER TREATMENT

Purpose of invention and sphere of application

Biosorption and filtration technology is used to provide fine waste domestic water treatment

Essence of invention

The invention is a unique solution of the water treatment issues as it:

- Maintains and intensively reproduces natural processes of purification and avoids negative impact of previous processes to the next ones
- Is much more efficient than bio-oxidation processes that lead to the decrease of oxygen demand for biological purification
- Provides conditions for self-ejecting water enrichment
- Provides damper hydroautomatic self-control of the processes in unsteady conditions and unmanned clearing maintenance

Intellectual property protection status

1 patent of Ukraine has been obtained

Market demand

The technology is implemented as a turn-key project on Ukrainian enterprises and has been tested on the plants in Algeria and Belgium.

Standby status

The full set of project and design documents for purification plants that are able to provide services to 50-50000 people and be used in Ukraine as well as abroad are developed

Key benefits of invention

The configuration can be made of steel, plastic, concrete steel and be either of vertical or horizontal construction. Modular design provides services to wide flow range of sewage water and results in:

- Water with maximum 3 mg/l contaminants and 5mg/l of biological oxygen consumption/requirement
- Usage of turbine pump and UV radiation water treatment appliance and reduction of power requirements to 0,05 kWh per capita per day
- No usage of consumable materials
- Decreased solid waste generation from 67g per capita per day to 20g per capita per day or from 1,34l to 0,40l of residue at 95 % humidity percentage
- 2-5 days of emergency recovery



R&D Department

20, Pershotravneva str., Kremenchuk 39600, Ukraine
e-mail: nich@kdu.edu.ua, <http://www.kdu.edu.ua>, Tel /fax: +38(05366) 3-62-17



WASTEWATER SLUDGE STABILIZING TECHNOLOGY

Purpose of invention and sphere of application

Technology is aimed at highly effective and environmentally friendly anaerobic digestion of wastewater sludges, liquid and semiliquid agricultural and other wastes for their stabilization (prevention of subsequent rotting), disinfection (removing pathogenic microflora) and obtaining biogas as energy carrier

Key benefits of invention

In comparison with known analogues, the technology allows to shorten duration of the digestion process from 15 to 3 days. It also allows increasing biogas output and increasing methane content in biogas from 60% to 95%. In addition, the technology allows additional obtaining commercial-grade carbon dioxide

Intellectual property protection status

1 patent of Ukraine has been obtained

Essence of invention

Technology provides applying of four different tanks for digestion: hydrolyzer, acidotank, acetotank and methanotank. In these tanks, four consecutive stages of anaerobic digestion take place: hydrolysis, acidogenesis, acetogenesis and methanogenesis. In each tank, optimal conditions are maintained for effective realization of each stage in accordance with modern understanding of kinetics of the stages

Market demand

The technology can be used at all sewage water treatment plants of Ukraine, which use biological treatment of sewage water

Standby status

The technological diagram of the R&D product

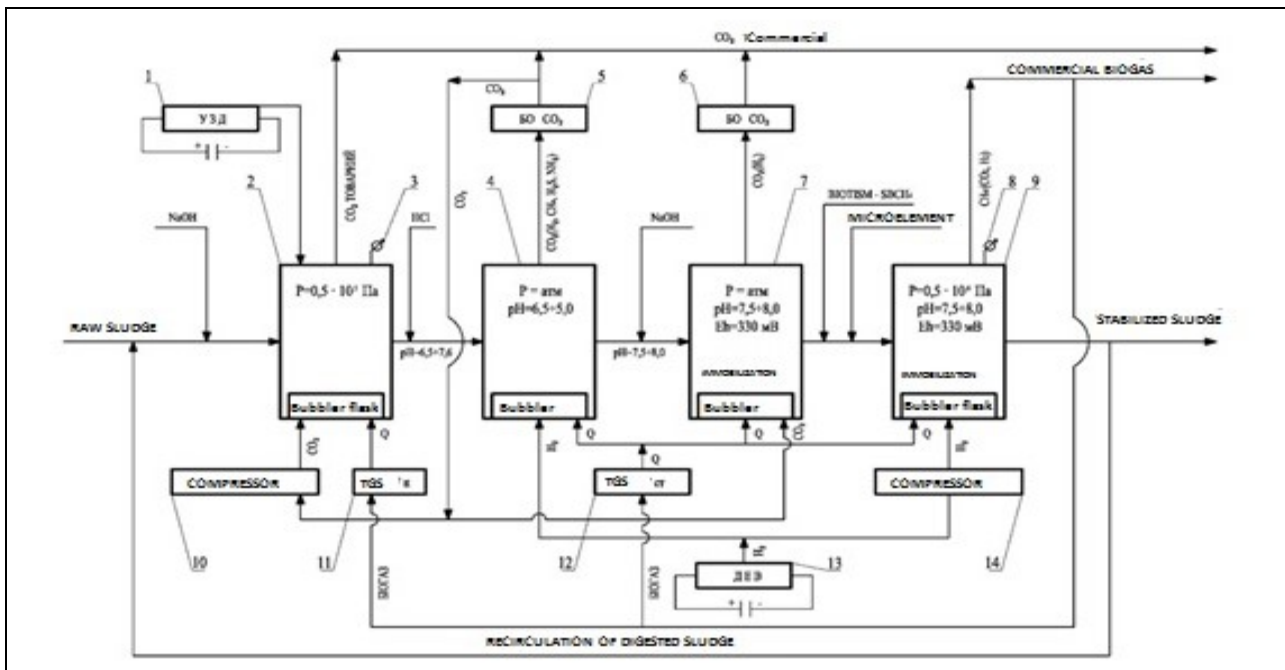

Department of Scientific and Technical Information

1, Kosmonavta Komarova ave., Kyiv, Ukraine
 e-mail: vtник@nau.edu.ua, http://nau.edu.ua/, Tel.: (044) 406-71-56, fax (044) 406-79-21



ADSORBENTS FOR INDUSTRIAL WATER AND OILS TREATMENT

Purpose of invention and sphere of application

The invented nanostructured adsorbent technology allows solving plant waste problem by manufacturing designated use products that are competitive on the world market of industrial adsorbents

Essence of invention

The solution to a problem of effective and cheap adsorbents local production production for various industrial processes is suggested. The original method of getting nanostructured adsorbents by sulphuric acid treatment was invented. Technological, physical and chemical parameters of this process are defined. Nanosorbents made of sunflower, corn cobs, nutshell are produced on the basis of suggested improved technology.

For production of 1 ton of adsorbent it is necessary to take 1, 2 ton of plant waste/refuse. 30 kg of adsorbent is used for adsorbent treatment of 1 ton of oil

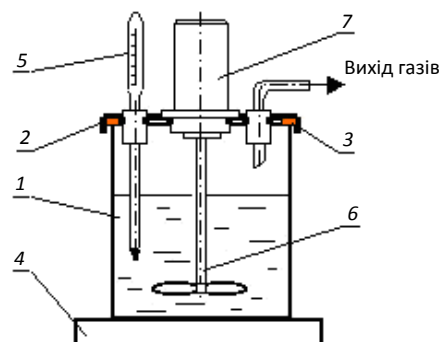

Laboratory equipment for adsorbent production
1 – cup; 2 – lid; 3 – seal; 4 – heater; 5 – thermometer;
6 – stirrer; 7 – stirrer motor

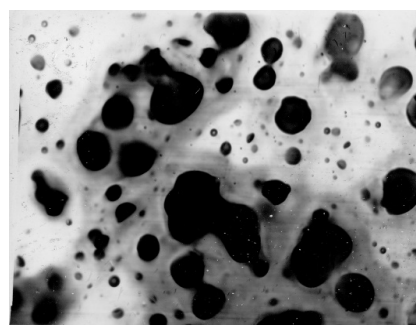

Structure of adsorbent surface

Key benefits of invention

The prime cost of adsorbent (1 UAH/kg) is 10 times less than the price cost of activated carbon/coal

Market demand

The technology of adsorbent sunflower oil treatment by modified adsorbent usage can be implemented on the working equipment of fat-and-oil plants refinery factories on the basis of the standard scheme

Intellectual property protection status

Utility model patent of Ukraine has been obtained

Standby status

Technological scheme of nanostructured adsorbents is designed and tested

R&D Department

20, Pershotravneva str., Kremenchuk 39600, Ukraine
e-mail: nich@kdu.edu.ua, <http://www.kdu.edu.ua>, Tel /fax: +38(05366) 3-62-17



ENVIRONMENTALLY FRIENDLY JET FUELS

Purpose of invention and sphere of application

Environmentally friendly jet fuels are intended for use at aircrafts of civil aviation, equipped with gas-turbine engines. The production of bio-additives according to the project has to be made of non-edible domestic feedstock

Key benefits of invention

Comparison with known analogues the application of environmentally safe fuels may help save 10–30% of mineral crude-oil feedstock and minimize negative impact of aviation on environment. Implementation of high-quality environmentally safe motor fuels will promote resource saving, energy efficiency and reduce impact of exhaust gases emissions in the atmosphere

Intellectual property protection status

3 patents of Ukraine have been obtained

Essence of invention

Environmentally friendly types of fuel contain jet fuel of oil origin, about 30% of overall volume. Designed exploratory samples provide the possibility to produce mixed herbal-mineral fuel of modified contents

Market demand

Due to its benefits ecologically safe fuel is demanded by civil aircraft industry, for the aircrafts equipped with jet engines

Standby status

A demonstration model has been designed. The technology has been successfully tested on jet engines



Department of Scientific and Technical Information

1, Kosmonavta Komarova Ave., Kyiv, Ukraine

e-mail: vtnik@nau.edu.ua, <http://nau.edu.ua/>, Tel.: (044) 406-71-56, fax (044) 406-79-21



INNOVATIVE SCHEME OF CONTROLLING OF MICROBIOLOGICAL CONTAMINATION AND BIOLOGICAL STABILITY OF AVIATION FUELS AND MATERIALS

Purpose of invention and sphere of application

The technology is designed to detect microbiological damage to aviation fuels and implement preventive measures for the elimination of microbiological contamination of the fuel system, the clogging of filters and violation of the operation of fuel regulating equipment, deterioration of physical and chemical and operational characteristics of fuel

Essence of invention

The essence of the developed colorimetric method for detecting the microbiological phase is that, as a result of the life of microorganisms, oil-detonators, fuels consist of compounds containing primary and secondary amino groups, amino acids, amines, enzymes, and the like. Cells of microorganisms have in their composition protein parts, which include the above compounds. Ninhydrin is chosen as an indicator on the amino group and the amino acid. During the interaction of ninhydrin with compounds containing abovementioned amino groups, a blue-violet colour is formed. The intensity of the colour indicates the extent of bioexcitation of the fuel

Key benefits of invention

In comparison with the already known analogues of microbiological fuels defeat detection methods, the colorimetric method developed by us makes it possible to identify the presence or absence of the microbiological phase more quickly

Intellectual property protection status

1 patent of Ukraine has been obtained

Market demand

The purity of fuels depends on the presence of mechanical impurities, moisture and microbiological phase. The method can be implemented by the airport services, testing laboratories, oil refineries, and petrol stations

Standby status

The method has been developed, implemented in the test activity of the laboratory

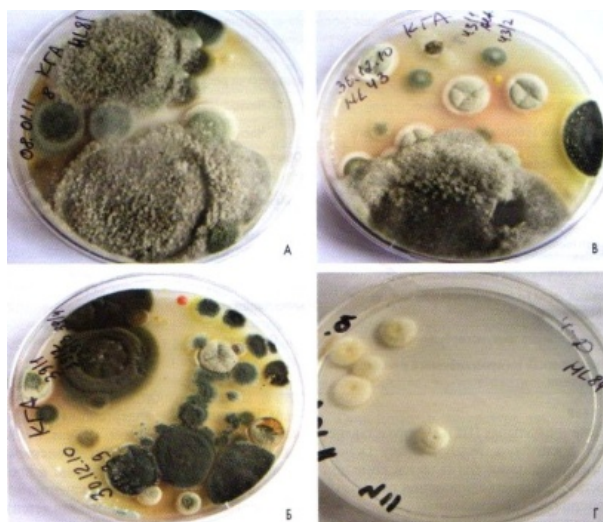

The appearance of colonies of microorganisms fused in a nutrient medium with petroleum hydrocarbons after the application of the microbiological contamination detection method

Department of Scientific and Technical Information

1, Kosmonavta Komarova Ave., Kyiv, Ukraine
e-mail: vtник@nau.edu.ua, http://nau.edu.ua/, Tel.: (044) 406-71-56, fax (044) 406-79-21



ADVANCED TECHNOLOGIES FOR THE PROCESSING OF TECHNICAL VEGETABLE OIL IN FUEL – LUBRICATING MATERIALS

Purpose of invention and sphere of application

The developed technologies allow to expand the base of production of lubricants at the expense of affordable and inexpensive technical vegetable oils, as well as technological and tribotechnical bases of resource-saving production of high-quality and environmentally friendly lubricants, transmission and hydraulic fluids, plastic oils, industrial oils based on rapeseed oil

Essence of invention

The technology helps to expand the assortment and to improve the quality of domestic lubricants. A number of new additives for base oils, as well as for technical oils of different classes, have been created, such as: emulsol "Rapломol-EP" – working concentration 3%, hydrogen index 7.5 – 8.5; density at 20°C – 978 – 987 r/sm³, corrosion resistance is maintained for TC.14-1-708.



Experimental samples of the working emulsion "Rapломol-EP" and paste-concentrate "Rapломol-P1v" for mechanical processing of metals

Key benefits of invention

The results of this work have a clearly expressed technical, economic and social effect. The development solves the current problem of resource conservation at the expense of renewable raw materials since it allows the production of new biological energy carriers: biofuel boiler and diesel; and bio-oils, bio-liquids and technical fluids, new additives for lubricants. It also solves a number of environmental problems: increases the safety of human ecology and the environment and contribute to the innovative development of the agro-industrial complex.

Intellectual property protection status

5 patents of Ukraine have been obtained

Market demand

Emulsol "Rapломol-EP" and Pastel-concentrate "Rapломol-P1v" are successfully used at the enterprises of Khmelnytskyi and Ukraine

Standby status

The developed technology is protected by patents of Ukraine, the technical documentation is developed, the work is ready for wide introduction at the enterprises of metal processing, rolling, and others

R&D Department

11 Instytutska str., Khmelnytskyi, 29016, Ukraine
e-mail: centr@khnu.km.ua; <http://www.khnu.km.ua/root/page.aspx>,
Tel.: (0382) 72-55-88; (0382) 67-02-76, fax: (03822) 67-42-65



ENVIROMENTALLY-FRIENDLY TECHNOLOGY OF MICROCRYSTALLINE CELLULOSE PRODUCTION FROM DOMESTIC NON-WOOD PLANT RAW MATERIAL

Purpose of invention and sphere of application

Microcrystalline cellulose (MCC) made from domestic plant material (flax and hemp) is intended for the production of solid dosage forms at the enterprises of the pharmaceutical industry as an alternative to import more valuable ICCs from coniferous wood and cotton

Key benefits of invention

The MCC from domestic vegetable raw materials corresponds to the best foreign analogues and requirements of the domestic and European Pharmacopoeia

Intellectual property protection status

1 patent of Ukraine has been obtained. A license agreement has been concluded on the use of patent

Market demand

The enterprises of the domestic pharmaceutical industry annually buy dozens of tons of imported ICC. Production of MCC from domestic vegetable raw materials partially solves the problem of import substitution, reduces the cost of final products by 20-30%, increases the competitiveness of production of domestic medicines

Standby status

Reference documentation is provided. Experimental samples are tested



Microcrystalline cellulose



Medicinal pills from the MCC



Department of Intellectual Property and Commercialization of R&D Products

37, Peremohy ave., Kyiv, Ukraine,
e-mail: komerc.patent@kpi.ua, <http://www.kpi.ua>
Tel./fax: +38 (044) 236-40-56



HIGH-SPEED METHANE CONCENTRATION METER FOR UNDERGROUND AIR OF COAL MINES

Purpose of invention and sphere of application

The technology deals with the development of competitive technologies, methods and means for measuring the concentration of hazardous gas substances in the underground air of coal mines, chemical, metallurgical plants, enterprises with increased explosive concentration of gas poisonous substances

Essence of invention

Measurement range of methane concentration is from 0 to 4^{vol} %. The value of the basic absolute measurement error of the methane concentration is no more than $\pm 0.1\%$ in the specified range. The value of the additional measurement error when temperature changes from +5 to +35°C does not exceed the basic measurement error. The value of the additional measurement error when dust concentration changes from 0 to 1 g/m³ does not exceed the basic measurement error in the same range of methane concentration measurement

Key benefits of invention

The speed of the meter does not exceed 0.15 sec, which is 5 times less than the regulated value of the speed (0.8 sec) with the magnitude of the basic measurement error of the methane concentration less than 2 times in the range of 0 to 4^{vol}%

Intellectual property protection status

27 patents of Ukraine on inventions and utility models have been obtained

Market demand

The meter can be used in the system of air gas protection of coal mines and industrial enterprises for the timely detection of gas volley emissions.

Standby status

Experimental samples of a high-speed methane concentration meter are developed, created and investigated. Requirements for the development of trial prototypes of the meter were provided

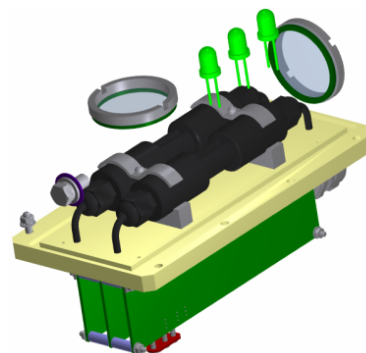
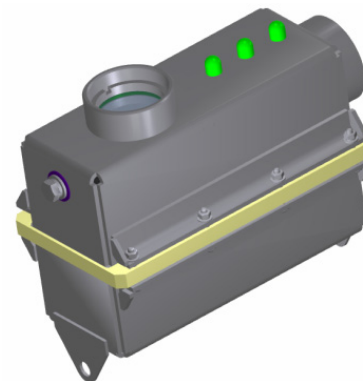

R&D Department

2 Shybankova sq., Pokrovsk, Donetsk oblast, Ukraine
e-mail: dntu_nich@i.ua, <http://donntu.edu.ua>, Tel. +38(050) 560-55-65



EXPLOSION SUPPRESSION SYSTEM

Purpose of invention and sphere of application

The main purpose of the localization and explosions suppression systems is to prevent the equipment destruction and the spread of flames in places of coal mining, transport communications, and related technological equipment

Essence of invention

The system provides the connection between the technology process control system and explosion localization and prevention system. In order to achieve the aim, immediate forced feed of extinguishing fluid in fire centers is used.

Response system time does not exceed 0,1 s;

The minimum diameter of the registered fire point from 5m distance of in the direction of the axis of vision is 0,75m.

The angle of flame sensor view is not less than 70 degrees.

The length of the explosion-suppressing zone under the cross-section output 10 m² is less than 15 m;

The rated voltage AC power source with frequency (50 ± 1) Hz: 36 V;

The power consumption is not more than 10 W

Intellectual property protection status

1 patent of Ukraine on utility model has been obtained.

Market demand

Mining of coal mines, localization of explosions in other underground structures and premises (in tunnels, mines, gas pumping stations, ventilation systems, underground, on wood-processing, flour-milling, paintwork and other enterprises, gas-oil companies, elevators, etc.), instant fire suppression in technical devices of military use

Standby status

Invention has been implemented at industrial enterprises



R&D Department, Centre of Scientific, Technical and Economic Information

2, Rymskoho-Korsakova str., Sumy, 40007, Ukraine
e-mail: dkurbatov@sumdu.edu.ua, info@cni.sumdu.edu.ua,
Tel./fax: +38 (0542) 68-78-69, +38 (05420) 33-41-08



ENERGY-CONDENSED GRANULAR SYSTEM UKRAYINIT-ANFO FOR THE REPLACEMENT OF TROTYL IN THE DESTRUCTION OF ROCKS

Purpose of invention and sphere of application

Energy-condensed granulated system Ukrayinit-ANFO is intended to replace TNT in the destruction of rocks in underground conditions. The system is characterized by a minimal amount of harmful explosive products, which is extremely important for mines with complicated ventilation

Essence of invention

Ukrayinit-ANFO (KM-1) has the appearance of loose granular mass from gray to brown and is characterized by high explosive-technical indicators: the critical diameter of open charge – 40-45 mm; heat of explosion – 3760 – 3820 kJ/kg; the speed of detonation in a steel shell – 3.2 – 3.8 km/s; at the volume of gas explosion 980 – 990 l/kg the amount of harmful gases in the explosion (in terms of conditional CO) is 27-38l/kg; the transition from deflagration to detonation in a closed volume is excluded; bulk density (20 ± 10) OC 750-950 kg / m³; sensitivity to friction on a Kop K-44-III, ≥ 702 MPa

Key benefits of invention

The developed technologies of agrarian granular ammonium nitrate modification ensure the production of a product with a uniform impregnation of granules without leakage and migration of the fuel phase for a long time (more than 3 months). As a fuel component, non-toxic products of processing vegetable fats that do not smell of petroleum products are used. The product does not contain TNT, aluminum, diesel fuel and mineral oils

Intellectual property protection status

The components and the technology are protected by 3 patents of Ukraine

Market demand

Ukrayinit-ANFO can successfully be used in underground mines for pneumatic charging of dry hollows and wells to replace standard trotyl explosives, which allows reducing the use of hazardous and toxic trotyl significantly

Standby status

The technology of obtaining Ukrayinit-ANFO is used in production according to the Ukrainian specifications



Modified pellets of ammonium nitrate and Ukrayinit-ANFO

Department of R&D Products Commercialization

8, Haharina ave., Dnipro, Ukraine, 49005

e-mail: udhtu@udhtu.edu.ua www.udhtu.edu.ua, Tel./fax: +38(0562) 47-33-97



RESOURCE SAVING METHODS OF LOWER SPACE MANAGING IN MEGAPOLIS

Purpose of invention and sphere of application

The technology solves the problem of geo-urban development planning, design and construction complexes of urban underground structures

Intellectual property protection status

1 patent application on invention has been submitted

Market demand

Cities, the population of which equals or exceeds 1 million inhabitants

Standby status

A concept based on suggestions concerning equipment of the lower space of Kyiv, has been introduced

Essence of invention

The essence of the development is to take into account the systemic connections of natural and man-made factors of structural-functional nature that substantially change with increasing scale of development of underground space from separate underground structures and a localized rock mass to multifunctional complex of underground city and its changing geological environment. The basic approach is based on the understanding of the problem development of underground space of the city, not as a one-time construction of individual underground structures, but as a realization of the system concept and strategic plan for the development of underground urbanism megacity, which correspond to trends development of the city in the future

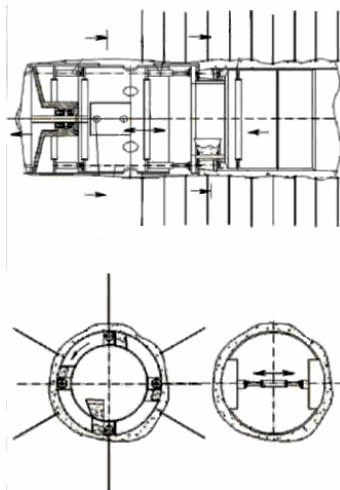

New cost-saving device of tunnels construction

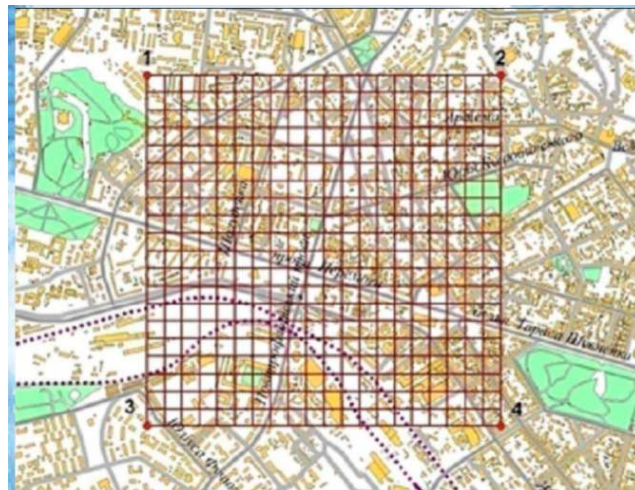

Territory zoning methods

Department of Intellectual Property and Commercialization of R&D Products

37, Peremohy ave, Kyiv, Ukraine, 03056

e-mail: lomer.patent@kpi.ua, <http://kpi.ua>, Tel./fax: +38 (044) 236-40-5

AFTERWORD

The development of market economy in Ukraine updated the activity of higher education towards commercialization of the new scientific knowledge being the basis for a great number of innovative projects practically demanded by the society. It is these inventions that are to sustain the innovative development of our country's economy.

For the last 10 years, the Ukrainian universities have developed modern infrastructure of innovative activity management. Its new forms include specifically science parks, educational investment and technological clusters, centres for research and technology and economic activity centres, business incubators, innovative centres and other departments the contact information of which is provided at the bottom of each information page dedicated to each specific innovation. Let us exemplify day-to-day innovative activity organization at some universities.

Innovative ecosystem Sikorsky Challenge at Igor Sikorsky KPI. The first science park was historically established at the National Technical University "Polytechnic Institute". Its activity is aimed at realization of the full range of actions intensifying the development, production and implementation of the science-driven competitive products in the domestic and foreign markets according to the Law of Ukraine On Science Park "Kyivska Politechnika" No. 523-V dated the 22nd of December 2006. The Science Park "Kyivska Politechnika" comprises prototyping laboratories and innovative workshops where both the scientists and the students can conduct the experiments necessary for the project to become commercially viable or to create the prototypes of their innovative projects to be provided for further development to the other departments of the university dealing with innovations.

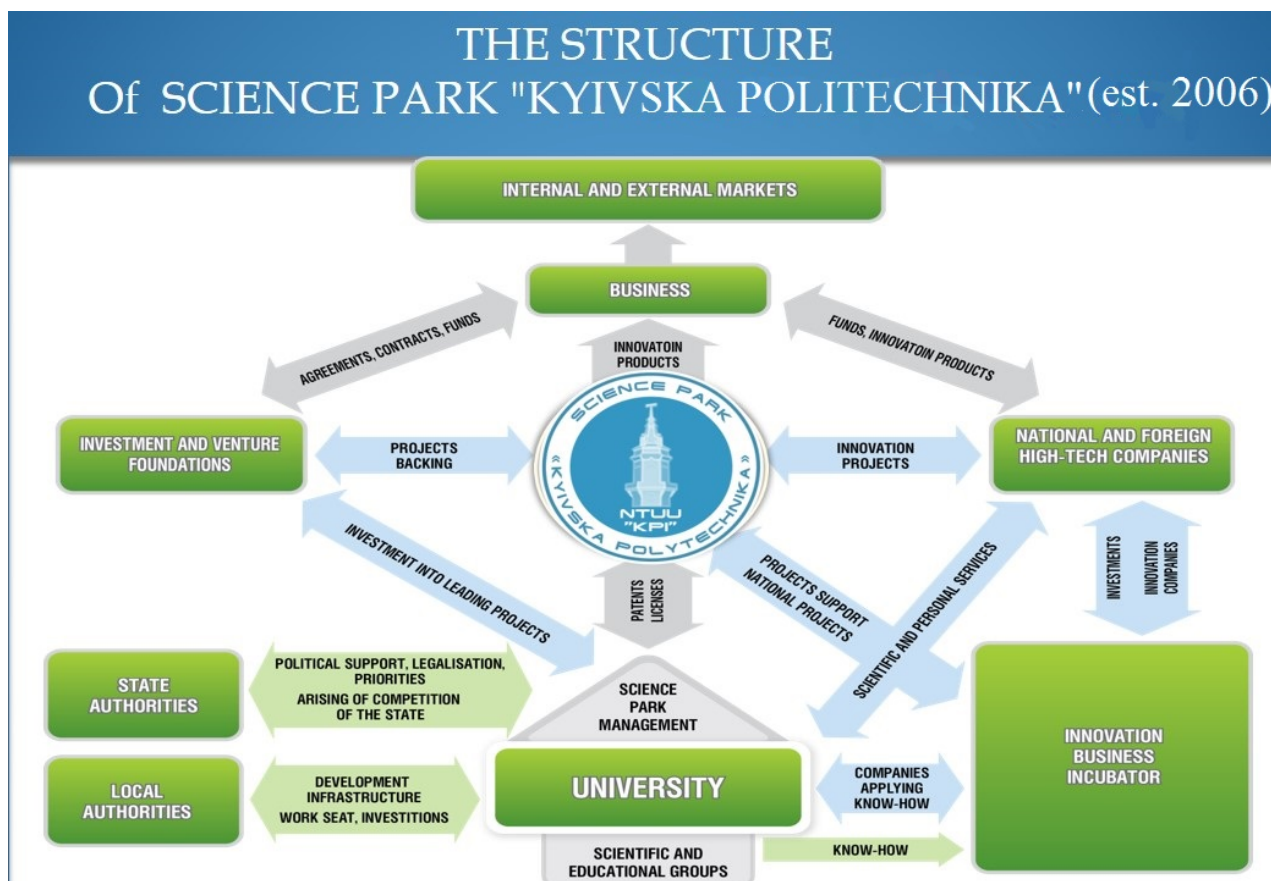

The activity of this science park allowed to gain first experience of innovative activity organization on the basis of mutual interests of the participants from education, science, government and business in order to commercialize the results of scientific researches and to implement them in the markets of Ukraine and abroad. This experience was used when passing the Law of Ukraine “On Science Parks” that led to the establishment of other similar parks in more than 20 Ukrainian universities.

Nowadays, National Technical University of Ukraine “Igor Sikorsky Kyiv Polytechnic Institute” has become the basis for the **innovative ecosystem “Sikorsky Challenge”**, comprising Science Park “Kyivska Politechnika”, start-up school, business-incubator, Innovative Production Association “Kyivska Politechnika”, Intellectual property centre, innovative holding, and a number of venture and investment funds.

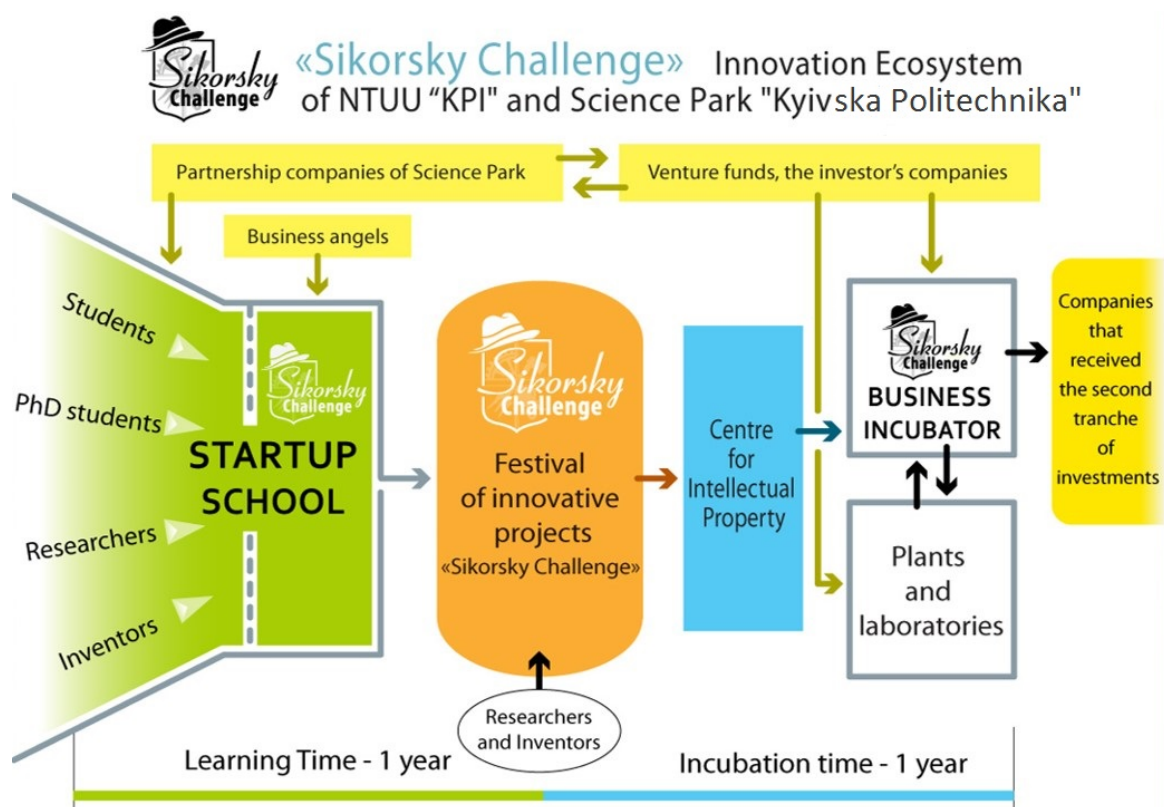

The activity of Igor Sikorsky KPI is organized in such way that over 30 investors, sponsors and dozens of venture funds, 5 commercial banks and 7 industrial enterprises are centred around the innovative environment. The aim of innovative ecosystem Sikorsky Challenge is to select, involve, and train creative people for them to become able to set up their own businesses and start-ups. It also helps the participants to find the investors and promote their start-ups. The priorities of the Innovation Ecosystem «Sikorsky Challenge» are the following:

- to attract and select the creative people from among the inventors, scientists and students of Igor Sikorsky KPI and other universities, research institutes, as well as business representatives, eager to be engaged in innovative entrepreneurship;
- to train the selected participants innovative entrepreneurship and to rise their motivation to develop their own technological ideas; to grow the business-ideas and to

facilitate the participants in their attempts to develop the projects and to prototype the business products;

- to search for investors and business angels for investing in promising projects (first and second rounds of investments);
- to select the best startup projects involving the coaches, experts, investors, business angels; to organize and hold the innovative business projects competition of the Festival «Sikorsky Challenge»;
- to help the authors of ideas in "adapting" their start-up projects according to the requirements of the possible investors;
- to participate in establishing and launching of start-up companies;
- to facilitate and support the participants in protection of their intellectual property rights (copyrights, patents, licenses);
- to provide legal, organizational, accounting services to startup-companies till the second round of investments
- to facilitate start-ups promotion to the international level;

For the last 6 years of the annual Festival of Innovative Projects “Sikorsky Challenge” there is a positive trend in the increased number of teams participating in the competition with their innovative projects. In 2012 by the results of the Festival 4 projects were chosen by two investors whose investments amounted 22, 5 thousand USD. In 2013 the number of chosen projects in was 5, in 2014 – 14, in 2015 – 23, in 2016 – 35 and in 2017 – 45 projects drew attention of 28 investors and sponsors, 10 investment funds and 5 commercial banks. It is important that the investors involved large transnational companies which will launch the ideas of the inventors on the global markets. It is equally important that Ukrainian investors also pay attention to domestic research, which is essential for the economy of Ukraine because of the necessity to further develop and pivot it on the innovative basis.



2017 Startup
competition
winners

Another form of commercialization of innovations of university scientists is the Innovative Production Association “Kyivska Politechnika” being a new for Ukraine model of bringing together science and innovation organizations and industrial enterprises, initiated by Scientific Park “Kyivska Politechnika”, State Concern “UkrOboronProm” and State Space

Agency of Ukraine. In 2015 the administration of National Technical University "Igor Sikorsky Kyiv Polytechnic Institute" signed the Memorandum on science and technology cooperation with the Ministry of Defence of Ukraine and State Concern "UkrOboronProm". Such cooperation is the basis for the model of the research university that includes 3 essential components: educational activity, research and innovations. The Innovative Production Association "Kyivska Politechnika", beside National Technical University "Igor Sikorsky Kyiv Polytechnic Institute" and Scientific Park "Kyivska Politechnika" also includes 7 enterprises in Kyiv: "Meridian" n. a. Serhij Korolyov, "ARSENAL", "KYIV AUTOMATICS PLANT", "Plant "Mayak", "Kyiv Scientific-Research Institute of Hydrodevices", "State Enterprise Production Association Kyivprylad", "ELMIZ". Their active cooperation is strongly exemplified in the project of unmanned aircraft system "Spectator", that went through all stages from the ideation to industrial production at "Meridian". The exploratory prototypes of the aircraft system "Spectator" were funded by the Foundation of the Scientific and Technological Development of Ukraine n. a. Academician V.S. Myhalevych. This resulted in the development of the unmanned aircraft system "Spectator" with 5,5 kg weight of flying machine, able to be launched manually and to perform pre-set tasks. Through the involvement of the experts from the armed forces it has become practically applicable being currently used by the Ministry of Defence of Ukraine and State Border Guard Service of Ukraine.

Especially noteworthy inventions of the Innovative Production Association "Kyivska Politechnika" also include small arms (in cooperation with "Plant "Mayak"), telecommunication systems (in cooperation with "ELMIZ"), sonar stations (in cooperation with "Kyiv Scientific-Research Institute of Hydrodevices"), nanosatellites PolyITAN-1 and PolyITAN-2 (in cooperation with "Kyivprylad"). After successful testing PolyITAN-2 was launched into orbit under QB50 project. Other successful examples of import substitution include water-purification system providing soldiers with water complying with the health standards regardless the source of such water, composite armour which provides 6th protection level being 30-40% lighter than traditional armour, slat armour for military machinery used in ATO-zone etc.

Educational investment and technology consumer goods industry cluster of Kyiv National University of Technologies and Design. The consumer goods industry cluster is the largest regional association of the manufacturers, research institutions and the executive body of Kyiv City Council (Kyiv City State Administration). The cluster includes approximately 1520 jobs and workplaces.

This new "architecture" and "design" of government's cooperation with business and science brought together business structures of the capital of Ukraine closely cooperating with scientific, education institutions, public organizations and municipal authorities. The Consumer Goods Industry Cluster was established as a result of cooperation of Kyiv City State Administration, Kyiv National University of Technologies and Design and 5 consumer goods industry enterprises – "Chinbar", "Scientific-Production Company "Hydrostyl", "Dana-moda", "RA.DA", "Kyiv shoe alliance".



On the 22nd of December 2015 the agreement on establishment of Consumer Goods Industry Cluster was signed envisaging that Kyiv City State Administration within the delegated authority facilitates the attraction of investments, provides informational support of the events and projects covered by this agreement involving participants in implementation of the municipal targeted programs. Providing appropriate scientific support to the Cluster the university in turn develops scientific, innovative, and

educational projects on the basis of the participating enterprises. The participating enterprises implement joint project in order to get competitive advantage by adoption of cutting-edge technologies in the production process.

Educational investment and technology consumer goods industry cluster was established to enhance the competitiveness of consumer goods industry enterprises, to provide high-tech and innovative development by bringing together industrial potential, resources of educational, scientific, R&D and innovative activities. Actually the Cluster was established to win back the domestic consumer goods industry market, where the science is able to contribute significantly to the increase in the number of workplaces.



Currently, 6 joint scientific and investment projects implemented within Cluster are scientifically supported by Kyiv National University of Technologies and

Design. Generally speaking, 18 projects were implement in cooperation with Kyiv City State Administration, Military Scientific Directorate of the General Staff of the Armed Forces of Ukraine, Centre of Logistics Development and Maintenance of the Armed Forces of Ukraine, Central Research Institute of Armament and Military Equipment of the Armed Forces of Ukraine and others. These projects include: "Special Purpose Leather and Shoes"; "Kyiv Armour" (personal protective equipment for Kyiv Police); "Blue protection" (special clothing for rescue and other activities); "School uniforms for Kyiv"; "Energy efficiency in the technological processes of leather, footwear, knitted and sewing goods manufacture"; "Shoes for pre-schoolers". Samples of the end products resulting from this cooperation were placed on International, Ukrainian and Municipal specialized exhibitions including: "Arms and Security 2016", "Made in Kyiv", "The First Spring Festival", etc. The Cluster members participated in

over 40 exhibitions and forums (taking part in 15 of them under the aegis of Kyiv City State Administration).

Broadly speaking, 11 public contracts, 4 license and other agreements totally amounting to 2.5 million UAH have been implemented since 2015. Within the period from 2015 to 2017 the economic impact of the activity of the Cluster participants amounted over 22 million UAH.



The Cluster enterprises manufactured over 15 thousand high-technology products. The year 2017 demonstrated the resulting increase in knowledge-based products by 5,6 %.

The cooperation in the field of defence capability of the state was significantly enhanced in 2016. On the 9th of December 2016 the Memorandum of intent on cooperation was signed between the Ministry of Defence of Ukraine and Kyiv National University of Technologies and Design. As a result, the first joint scientific conference with Military Scientific Directorate of General Staff of the Ukrainian Armed Forces "Actual problems of the basic battlesuits development for the Armed Forces of Ukraine", was held on the 25th of May 2017 identifying the key priorities and potential participants of the joint projects.

Such "architecture" of cooperation of the industry and science representatives facilitated by the municipal authorities resulted in the commencement of 6 projects. Collaborating as research teams the students have an opportunity to realize their scientific potential with the support of the Cluster participants and, as a result, to become the competitive experts in the Ukrainian and European labour markets.

The experience of Sumy State University. The activity of the Centre of Scientific & Technical and Economical Information as a structural unit of Sumy State University is aimed to increase the efficiency of the scientific research commercialization.

The key tasks of the Centre as the integral part of the R&D Sector of the University are the following:

- to do research in the field of scientific, technical and economic information;
- to provide information support to scientific, technical, innovative and grant activities;
- to operate as interregional centre of innovative activity;
- to inform the representatives of science, education, industry, business and different authorities as well as other interested persons and organizations about the results of scientific research, R&D projects and methodological activities;
- to establish new contacts and strengthen the existing communication and cooperation of the scientists representing different regions of Ukraine and other countries;
- to facilitate the realization of the innovative potential of the university by implementing the results scientific and scientific-methodological activity;

– to enhance publication activity of Sumy State University scholars and the credibility of their works in the global scientific community;

Innovations, services, and technologies developed at Sumy State University are integrated in “Scientific and Technical Developments” service, while potential customer enterprise may be contacted using the “Technological Requests” service. In order to integrate the results of Sumy State University scholars in the innovations and services market “Regional informational resource of innovations” (<http://innovation.sumdu.edu.ua>) was established bringing together the science and the industrial enterprises. This resource enables to combine the information about the innovations of different regional scientific institutions and enterprises, service for the requests on performing various tasks in different industries, forum for information exchange between the scientists and entrepreneurs, latest news about the innovations in the region and scientific and technical events calendar on one information platform.

Business-incubator of the National Mining University (since 2017 – NTU “Dniprovsk Politechnika”). The structure of National Mining University Business-incubator comprises the organizational department focusing on data collection and analysis, information and agitation activity, organizing and holding of the conferences, presentations, contests; the training and advisory department dealing with methodological activity, organizing consultations and lectures; and the business department providing advisory services to support the process of establishment and operation of the enterprises.

In order to achieve the aforementioned objectives in 2017 the Business Incubator implemented the following projects:

1. The Startup School “Dnipro Sikorsky Challenge” being the joint project of National Mining University and Igor Sikorsky KPI. The Startup School is a regional centre of startup-infrastructure organized on the basis of the National Mining University according to “Sikorsky Challenge” methodology is the participant of “Sikorsky Challenge” startup school network. The education in “Dnipro Sikorsky Challenge” started in November 2017 and the pilot program is participated by Igor Peer, the senior partner of the Innovation Ecosystem “Sikorsky Challenge” and the CEO of the International Business Incubator “Be Next IT” (Israel).

2. Student academic incubator program (organized within the YEP Incubators project) being the joint project of National Mining University and Public organization “Innovation Partnership Platform” (Kyiv city).

V. N. Karazin Kharkiv National University Innovation Centre. The innovation Centre operates mostly to create the university environment aimed at efficient usage of scientific, scientific-technical and technological potential of the university for the further development, implementation and industrial exploitation of the new equipment, high-technology products, emerging technologies, materials and other products of intellectual activity of the university scholars and employees, students and post-graduates; to involve university scholars and

employees, students and post-graduates in vigorous research activity related in the field of the high and innovation technologies; to develop and implement innovative approaches and methods in educational process.

Innovation Centre forms information database of the university innovations, national and global funds, innovation projects funding programs, as well as various grants.

The tasks of the Centre are performed by conclusion of the agreements on funding the innovations of V. N. Karazin Kharkiv National University with international and national financial organizations, institutions and funds; by conclusion of the agreements on commercialization of devices, goods and other products designed at the university involving private, joint and state funding; by search for the research grants to provide them for the university employees.

The Science Park of the National University of Life and Environmental Sciences of Ukraine “Sustainable Environmental Resources Management and Life Quality”. The park was established on the 25th of July 2013 by the National University of Life and Environmental Sciences of Ukraine and State Enterprise “Educational and Research Breed Poultry Plant” to facilitate the innovation activity at the university, to commercialize the results of scientific research and implement them in the domestic and external markets.

The Science Park has already implemented science and innovation projects in different fields including industrial approbation of the agricultural crops and of their protection agents, growth stimulators and technologies of growing, determination of the biological assays of nanomedicines, study of the radionuclide pollution of forest ecosystems.

The Science Park strongly facilitates the development of startup-movement at the university. Under its aegis the Startup-School of National University of Life and Environmental Sciences of Ukraine (<https://startupschool.wixsite.com/nubip>) was established training its students to implement their business ideas under the guidance of foreign and Ukrainian business coaches. The meetings with famous experts in the field of technology transfer and R&D projects commercialization, venture fund representatives and strategic investors are constantly held for teachers, research associates, students and post-graduates of the university.

The priorities of the Science Park are the following:

- Creation of new innovative products and taking further measures for their commercialization;
- Facilitation of the development of the innovation companies in agricultural sector;
- Search for potential investors and partners;
- Innovations management;
- Advisory activities of the experts in the field of agricultural economy, business development, environment and agricultural science;
- Multidisciplinary research and experimental development;
- Carrying out the physical, chemical and other tests.

List of the Science Parks of Higher Education Institutions

1. Science Park “Kyivska Politehnika”.
2. Science Park “Taras Shevchenko University of Kyiv”.
3. The Science Park of the National University of Life and Environmental Sciences of Ukraine “Sustainable Environmental Resources Management and Life Quality”.
4. Science Park «Aerospace innovation technologies » of National Aviation University.
5. Science Park of Odesa National Polytechnic University.
6. Science Park of National Technical University “Kharkiv Polytechnic Institute”.
7. Science Park «Radio Electronics and Informatics» of Kharkiv National University of Radio Electronics.
8. Science Park of Kyiv National Economic University named after Vadym Hetman.
9. Science Park “Uzhhorod National University”.
10. Science Park «Chemical Technologies» of Ukrainian State University of Chemical Technology (Dnipro).
11. Science Park «DonNU-Podillya» of Donetsk National University in Vinnytsia.
12. Science Park «Precarpathian University» of Vasyl Stefanyk Precarpathian National University (Ivano-Frankivsk).
13. Science Park «Biometric innovation-technological cluster «BITeC» of Odesa National Medical University.
14. Science Park «Innovation-Investment cluster Ternopillya» of Ternopil Ivan Puluj National Technical University.
15. Science Park “AGROPERSPEKTYVA” of Mykolayiv National Agrarian University.
16. Science Park «Naukograd-Kharkiv» of O.M.Beketov National University of Urban Economy in Kharkiv.
17. Science Park “CHORNOBYL” of State Environmental Academy of Graduate Studies and Administration (Kyiv).
18. Science Park «Agrozoovet» of Kharkiv State Zooveterinary Academy.
19. Science Park «Energy-Efficiency Technologies» of Poltava National Technical Yuri Kondratyuk University.

Research and reference work

INNOVATIONS OF UNIVERSITIES AND SCIENTIFIC INSTITUTIONS OF MES OF UKRAINE

The project is carried out by the resolution of the Presidium of the Council of Vice-Rectors for Research and Directors of Scientific Institutions of MES of Ukraine

Drafters

Development of a format for information on the publication's innovations and structure	M.V. Strikha, M.Yu. Ilchenko
Preparation of the content of information pages (IP) on the development of universities	Vice-Rectors for Research of universities
Examination and selection of provided IP	V.V. Kaplun, S.V. Pavlov, V.V. Otchenashko
IP scientific editing and their structuring in the collection, preface and afterword	M.Yu. Ilchenko
Literary and technical editing, adjustment	O.P. Demydenko
Artistic finish and computer layout	O.M. Nesterenko
Interaction of the working group with universities	O.V. Savich
Print edition organization	V.V. Kamyshin
Electronic edition organization	O.V. Savich

Signed for printing

Format

Conventional printed sheets

Edition of ____ copies

Calibri

Published sheets

ACTIVATION PERIODS OF MAIN PROJECTED DRIVERS (CLUSTERS)

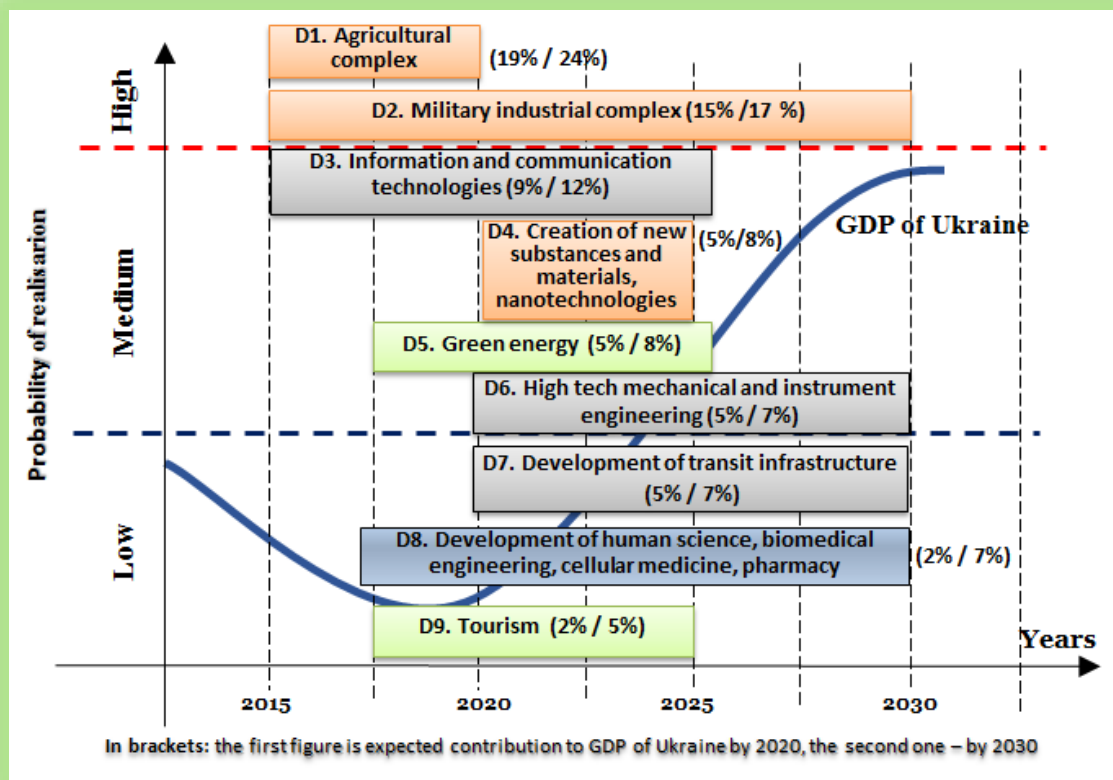

Scenarios of socio-economic development of Ukraine by 2020 and 2030 years (FORESIGHT project)